

Test & Measurement Catalog 2011/12

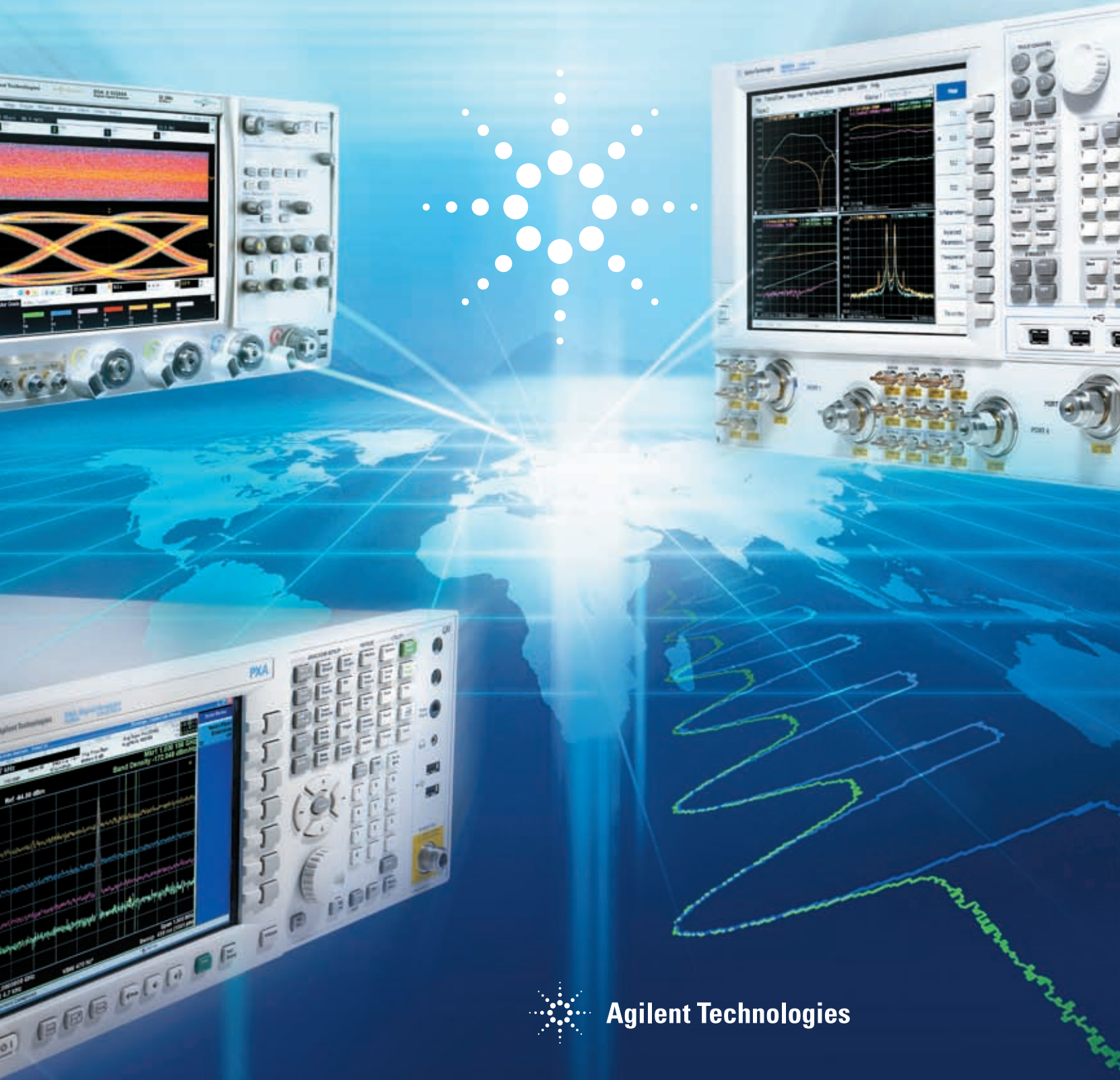

Agilent Technologies

Welcome to Agilent Technologies



Thank you for exploring new solutions from Agilent Technologies. As the world's premier measurement company, we work in close collaboration with you and other engineers and researchers around the globe to meet the communications and electronics challenges for today and tomorrow. Our electronic measurement business is focused on delivering technology-leading products and cost-effective solutions. And our strong investment in R&D allows us to provide the measurement solutions to help you deliver the products and services that make a measurable difference in the lives of people everywhere.

I am delighted to share the solutions that help you and other engineers – from design, development, manufacturing, installation, deployment and operation of electronic equipment and systems, to communications networks and services.

Sincerely

A handwritten signature in black ink, appearing to read 'Ron'.

Ron Nersesian

Agilent Technologies, Inc.
Electronic Measurement Group President

Agilent Technologies

The company's 18,500 employees serve customers in more than 110 countries. These customers include many of the world's leading high-technology firms. They rely on Agilent's products and services to increase profitability



I'm pleased to present the 2011/12 edition of the Agilent Test and Measurement Catalog. As you look through it, you will find unmatched depth and breadth of products, solutions and services to help you improve your business results.

As the world's premier measurement company, the Agilent Technologies Electronic Measurement Group is firmly committed to being the measurement solutions partner to every engineer and scientist in the electronic markets.

Around the world, Agilent employees and partners value strong customer relationships. We count on your feedback to ensure that we continue to meet your needs. We hope you'll always look to Agilent for innovative products and solutions to help you reach your business goals.

Sincerely,

Saleem Odeh

Agilent Technologies, Inc.
Electronic Measurement Group Vice President and
General Manager
Sales, Service and Support

and competitiveness, from research and development through manufacturing, installation and maintenance. Agilent enables its customers to speed their time to market and achieve volume production and high-quality precision manufacturing.



Agilent Technologies

The world's premier measurement company.

we are investing in the future of measurement.

News

About Agilent



- Company Information
- Newsroom
- Community Relations
- Working with Agilent
- Crisis Management

Investor Relations
Jobs

- Products & Services
- Industries
- Technical Support
- Literature Library
- Training & Events
- Buy

Life Sciences & Chemical Analysis

- Instruments & Systems
- Columns & Supplies
- Reagents, Standards & Kits
- Informatics & Software
- Clinical Diagnostics
- Services

* The new HPLC standard is here: Agilent 1200 Infinity Series

Infinitely better



Electronic Test & Measurement

- Oscilloscopes, Analyzers, Meters
- Generators, Sources, Supplies
- Software
- Modular Products and Systems
- Additional Test & Measurement Products
- Services

* Expand your choices and capabilities—dramatically—with AXIe and PXI



See what's new

Agilent Technologies

Search: All Test & Measurement

Register your products for service notifications, firmware updates alerts, application notes & more

Products & Services

- Oscilloscopes, Analyzers, Meters**
 - Oscilloscopes
 - Spectrum Analyzer (Signal Analyzer)
 - Network Analyzer
 - Logic Analyzers
 - Protocol Analyzers and Exercisers
 - FMI/FMC, Phase Noise, Physical Layer Test
 - Bit Error Rate Test (BERT) Solutions
 - Digital Multimeter, Voltmeters
 - Power Meters & Power Sensors
 - Frequency Counter Products
 - Noise Figure Analyzers & Noise Sources
 - LCR Meters & Impedance Measurement Products
 - Digitizers
 - DC Power Analyzers
 - Dynamic Signal Analyzers, Mechanical & Physical Test
 - Parameter & Device Analyzers, Curve Tracers
- Generators, Sources, Supplies**
 - Signal Generator (Signal Source)
 - Function / Arbitrary Waveform Generators
 - Pulse Generator Product Portfolio
 - Data Generators & Analyzers
 - DC Power Supplies
 - Source Measure Units
 - DC Electronic Loads
 - AC Power Sources / Power Analyzers
- Software**
 - Agilent ESD EDA Design & Simulation Software
 - Agilent VEE
 - Instrument Software
 - Agilent License Manager 3.3
 - Fault Detective 4.7
 - IO Libraries Suite 15.5
 - Calibration & Adjustment Software
- Modular Products and Systems**
 - Modular Products and Systems
 - 31970A Modular Products & Systems
 - 34980A Modular Products & Systems
 - AXIe Modular Products & Systems
 - PCI/PCI Express/CompactPCI/VME Modular Products & Systems
 - PXI Modular Products & Systems
 - USB Modular Products & Systems
 - VXI Modular Products & Systems
 - Modular Mainframes and Controllers
 - Modular Arbitrary Waveform Generators
 - Modular Bit Error Rate Test Systems
 - Modular Frequency Counters
 - Modular Digital to Analog Converters
 - Modular Data Acquisition and Switching
 - Modular Oscilloscopes and Digitizers
 - Modular Digital IO
 - Modular Digital Multimeters
 - Modular Pulse Pattern Generators
 - Modular Signal Conditioning
 - Modular Source Measure Unit
 - Modular Vector Signal Analyzers
 - Software for Modular Products and Systems
 - Accessories & Options for Modular Products
 - Modular Logic Analysis and Protocol Test
- Services**
 - Repair & Calibration Services
 - Online
 - Register your product
 - Check warranty status
 - Agilent Solutions Partners
 - Application Engineering Services

Privacy Statement | Terms of Use | Webmaster | Contact Agilent | About Agilent | United States Home | © Agilent 2000-2010

1

Table of Contents, Product Number Index

Table of Contents, Product Number Index

1

New Products

2

Oscilloscopes, Analyzers, Meters

3

Generators, Sources, Supplies

4

Software

5

Modular Products and Systems

6

Additional Test & Measurement Products

7

Used Agilent Test Equipment, Support & Services

8

Contact Agilent

9

Table of Contents

Agilent Technologies Test & Measurement Catalog 2011/12

1 Table of Contents, Product Number Index

2 New Products

PXI Modular Instrumentation	2
M9392A PXI Modular Microwave Signal Analyzer	2
Handheld Spectrum Analyzers	3
X-Series Signal Analyzers	3
PSG Option UNY Enhanced Ultra-Low Phase Noise	4
89600B VSA Software	4
Signal Studio Software	5
N5247A PNA-X Microwave Network Analyzer	5
ENA Option TDR for High Speed Serial Interconnect Analysis	6
E5061B-3L5 LF-RF Network Analyzer	6
High Performance Benchtop Millimeter-Wave Network Analyzers	7
Physical Layer Test System (PLTS Version 5.5)	7
Infiniium 90000 X-Series Oscilloscopes	8
81180A 4.2 GSa/s Arbitrary Waveform Generator	8
86100D DCA-X Wide-Bandwidth Oscilloscope	9
Digital Test Console PCI Express Protocol Test System	9
N6780 Series Source Measure Units	10
U1270 Series Handheld Digital Multimeters	10
53200 Series RF and Universal Frequency Counters/Timers	11
33500 Series 30 MHz Waveform Generators	11
N7105A Signal Monitoring System	12
N6841A RF Sensor for Signal Monitoring Networks	12

3 Oscilloscopes, Analyzers, Meters

Oscilloscopes

Oscilloscopes Selection Guide	14
U1600 Series Handheld Digital Oscilloscopes	15
U2701A/U2702A USB Modular Oscilloscopes	16
1000 Series Performance Economy Oscilloscopes	17
InfiniiVision 5000 Series Portable Oscilloscopes	19
InfiniiVision 6000 Series Portable MSO and DSOs	22
InfiniiVision 7000B Series Portable MSO and DSOs	24
Infiniium 9000 Series MSO and DSOs	26
Infiniium 90000A Series High Performance Oscilloscopes	28
Infiniium 90000 X-Series High Performance Oscilloscopes	30
86100D DCA-X Wide-Bandwidth Oscilloscopes	32
Oscilloscope Probes and Accessories	35
Oscilloscope Application Software	43

Signal Analysis

Signal Analysis Overview	45
N9030A PXA Signal Analyzer	49
N9020A MXA Signal Analyzer	52
N9010A EXA Signal Analyzer	54
N9000A CXA Signal Analyzer	56
X-Series Advanced Measurement Applications	59
89600B Vector Signal Analysis Software	61
E444xA PSA High Performance Spectrum Analyzers	63
ESA Series Economy Portable Spectrum Analyzers	65
856xEC Midrange Spectrum Analyzers	68
N9320B RF Spectrum Analyzer	69
N9340B and N9342C Handheld Spectrum Analyzers	70
External Mixers, Amplifiers, and Other Accessories	72
U8903A Audio Analyzer	73
Replacement Models for Discontinued Signal Analysis Products	74
M9392A PXI Vector Signal Analyzer	75
M9361A PXI Downconverter	75
M9351A PXI Downconverter	76
M9302A PXI Local Oscillator	76
M9360A PXI Attenuator/Preselector	77
M9202A PXIe IF Digitizer	77
Synthetic Instrument Modules	78

Network Analyzers

Network Analysis Overview	79
ENA Network Analyzer	83
E5061B LF-RF Network Analyzer	85
ENA-L RF Network Analyzer	87
PNA, PNA-X and PNA-L Series MW Network Analyzers	88
Network Analyzer Accessories	95
N9912A FieldFox Handheld RF Network and Spectrum Analyzer	99
N9923A FieldFox Handheld RF Vector Network Analyzer	100

Logic Analyzers

Logic Analyzers Selection Guide	101
16800 Series Portable Logic Analyzers	102
16900 Series Modular Logic Analysis Systems	103
16720A Pattern Generator Module	104
Logic Analyzer Probes	105
DDR Memory Test Solutions	106
FPGA, ARM, Processor, Bus and Application Solutions	107

Protocol Analyzers and Exercisers

Protocol Solutions Overview	108
PCI Express Protocol Test Solutions	109
DigRF Protocol Test Solutions	111
HDMI Protocol Compliance Test	113
D-PHY Protocol Test Solutions	114

EMI/EMC, PLTS, Signal Monitoring

EMI Receiver and EMC Measurement Application	116
Physical Layer Test System	117
Signal Monitoring Systems	118

Bit Error Ratio Test (BERT) Solutions

BERT Overview	119
N4903B J-BERT High-Performance Serial BERT	120
N4916B De-Emphasis Signal Converter	121
N4876A Multiplexer	121
Serial BERT 3.6 Gb/s and 12.5 Gb/s	122
3.125 Gb/s Manufacturing Serial BERT	123
ParBERT 81250	124
PXI Modules for Optical Transceiver Testing	126

Digital Multimeters

Digital Multimeter Selection Guide	127
34405A and U3400 Series Digital Multimeters	129
34401A and 34410A Series 6½ Digit Multimeters	130
34420A Nanovolt/Micro-ohm Meter	132
3458A 8½ Digit Multimeter	133
U3606A Digital Multimeter/DC Power Supply	134
Handheld and USB Modular Digital Multimeters	135

Power Meters and Power Sensors

Power Meter and Power Sensors Selection Guide	137
Peak Power Meters and Power Sensors	138
Average Power Meters and Sensors	139
Power Analysis Manager	139
U2000 Series USB Power Sensors	140
V3500A Handheld RF Power Meter	140

Frequency Counters

Universal and RF Counter Selection Guide	141
RF Counters, Frequency and Time Interval Counters	142
Microwave Counters	144

Noise Figure Analyzers and Noise Sources

NFA Series Noise Figure Analyzers	145
Noise Sources	147

LCR Meters & Impedance Measurement Products

Component Test Instruments Overview	149
4294A Precision Impedance Analyzer	152
E4991A RF Impedance/Material Analyzer	153
4263B LCR Meter	154
E4980A Precision LCR Meter	154
4285A Precision LCR Meter	155
4287A RF LCR Meter	155
E4981A Capacitance Meter	156
4338B Milliohmmeter	157
4339B High-Resistance Meter	157
U1700 Series Handheld LCR Meters	158
Signal Source Analyzer	159

Digitizers

Modular Digitizers and Data Converters in cPCI, PCI, PCI Express, VME	160
M9210A PXI-H 10-bit Digitizing Scope	162
M9211A PXI-H 10-bit UWB IF Digitizer	162
M9202A PXI Express 12-bit Wideband IF Digitizer	163
L4532A 2-Channel and L4534A 4-Channel Digitizer	164

Dynamic Signal Analyzer

35670A Dynamic Signal Analyzer	166
--------------------------------	-----

Parameter and Device Analyzers, Curve Tracers

Overview	167
B1500A Semiconductor Device Analyzer	169
B1505A Power Device Analyzer/Curve Tracer	170
4155C/4156C Semiconductor Parameter Analyzer	171
Modular SMU Series	172
Low Leakage Switch Matrix Family	174

Semiconductor Production Test System

4080 Series Parametric Tester	176
-------------------------------	-----



Table of Contents

Agilent Technologies Test & Measurement Catalog 2011/12

4 Generators, Sources, Supplies

Signal Generators

Overview	178
Analog Signal Generators Key Specifications	180
E8257D PSG CW and Analog Signal Generator	181
OML Inc. Millimeter-Wave Modules	184
E8663D PSG RF Analog Signal Generator	185
E4428C ESG RF Analog Signal Generator	187
N5181A MXG RF Analog Signal Generator	189
N5183A MXG Microwave Analog Signal Generator	191
N9310A RF Signal Generator	193
Vector Signal Generators Key Specifications	194
E8267D PSG Vector Signal Generator	195
E4438C ESG RF Vector Signal Generator	199
N5182A MXG RF Vector Signal Generator	201
Signal Studio Software	203
N5106A PXB Baseband Generator and Channel Emulator	205
N5102A Digital Signal Interface Module	206
Replacement Models for Discontinued Signal Generators	207

Function/Arbitrary Waveform Generators

Function/Arbitrary Waveform Generator Selection Guide	208
33200 Series Function/Arbitrary Waveform Generators	210
33500 Series Function/Arbitrary Waveform Generators	210
Arbitrary Waveform Generators, 1.25 GS/s, 15 bit	212
Arbitrary Waveform Generators, 4.2 GS/s, 12 bit	213

Pulse Generators, Data Generators and Analyzers

Pulse Pattern Generators from 1 MHz to 3.35 GHz	214
Data Generators and Analyzers for Functional and Parametric Tests	218

DC Power Supplies/Analyzers/Electronic Loads/AC Power Solutions

Power Supply Cross Reference Guide	219
6600 Series System DC Power Supplies	220
6030 Series System DC Power Supplies	221
66300 Mobile Communications DC Sources	223
E4360 Series Solar Array Simulators	225
N6700 Series Modular Power System and DC Power Analyzer	226
N6780 Source Measure Units	228
N5700 and N8700 Series, 750 W to 5K W Single Output	230
N3300 High Performance Electronic Load Family	232
6060B and 6063B Single Input DC Electronic Loads	234
6800 AC Power Solutions	235
E3600 Series and U8000 Series Bench Power Supplies	236

Source Measure Units

4-Quadrant General Purpose USB Modular SMU	240
N6700 SMU Module Family	240
Precision SMU Family	240

5 Software

EEsof EDA Design and Simulation Software

Agilent EEsof EDA Products Overview	244
Advanced Design System	245
Electromagnetic Professional (EMPro)	246
RFIC Design Flow	246
GENESYS	247
Integrated Circuit Characterization and Analysis Program (IC-CAP)	248
System-Level Design and Verification	249

Agilent VEE

VEE Pro 9.2 and VEE Express 9.2	250
---------------------------------	-----

6 Modular Products and Systems

Overview	252
Modules Selection Guide	254

7 Additional Test & Measurement Products

Data Acquisition Hardware & System Switching

34972A Data Acquisition/Switch Unit	258
34980A Multifunction Switch/Measure Mainframe and Modules	260
L4400 Series LXI Switching and Control Instruments	263
USB Data Acquisition and Switching Modules	264
PXI Data Acquisition and Switching Modules	267

Wireless Device Test Sets & Wireless Solutions

8960 Series 10 Wireless Communications Test Set, Model E5515C	269
8960 Lab Applications	270
Protocol Analysis and Functional Test Software	274
Wireless Test Manager Software	275
8960 Test Applications	276
Wireless Connectivity Test Set	283
PXT E6621A and LTE Signaling Conformance Test	284
EXT Non-Signaling Wireless Communications Test Set	285
Mobile WIMAX Test Set	286
Wireless Networking Test Set	287
GS-8800 Series (8960) Design Verification and Conformance Test Systems	288
GS-8800 Series (8960) Design Verification Benchtop Systems	289
GS-8800 Series (PXT) Design Verification Benchtop Systems	290

Automated Test Systems and Application – Specific Test Systems

Medalist i3070 Series 5 In-Circuit Test System	291
Medalist i1000D In-Circuit Test System	292
Automotive Functional Test Systems	293
Automotive Infotainment and Telematics Functional Test Systems	293
TestExec SL Software	294

Photonic Test & Measurement

Lightwave Measurement Solution Platform	295
81600B Tunable Laser Modules	297
819xx Family Compact Tunable Laser Modules, N771xA Series Tunable Laser Sources	298
8165xA Fabry-Perot and 81663A DFB Lasers, 81595B Optical Switch Module	299
Optical Power Measurement Modules	300
Multiport Optical Power Meter and Optical Attenuators	301
Polarization and Dispersion Analysis	303
Optical Spectral Analysis	306
Optical Transceiver Test	307

Atomic Force Microscopes, Nanoindenters

Atomic Force Microscopes	311
Nanomechanical Testing Systems	315

GPIO, USB, and Instrument Control Products

PCI GPIO Interface Card, PCIe-GPIO Interface Card	319
USB/GPIO Interface, USB/RS-232 Interface	320
LAN/GPIO Gateway, Networked 5-Port USB Hub	321
Cables and Adapter	322

RF and Microwave Test Accessories

Active Differential Probes	323
PXI Hybrid Switch Module	324
High Performance SPDT and Bypass Switches	325
Low Cost High Performance SPDT and Bypass Switches	326
High Performance Multiport, Matrix and Transfer Switches	327
Economical High Performance Multiport and Transfer Switches	328
Solid State Switches	329
Attenuation Control Units	330
Coaxial Step Attenuator	331
RF/Microwave Switch Platform	333

8 Used Agilent Test Equipment, Support & Services

Used Test Equipment and Finance Solutions

Premium Used Equipment	336
Premium Trade-In Solutions	336
Buy-Back	336
Lease and Finance	336
Rent or Rent to Buy	336

Repair and Calibration Services

Repair Services	337
Calibration Services	337
Volume On-Site Calibration Services	338
Infoline Web Services	338

Application Engineering Services

Product, Education and Application Services	339
Online Technical Support	340

9 Contact Agilent

Local Assistance	342
------------------	-----



Product Number Index

10070C – 4338B

1

10070C	Passive probe	18, 35-37
10072A	SMT probe accessory kit	37, 42
10072A	SMT probe accessory kit	37, 42
10073D	Passive probe	35-37
10074C	Passive probe	22, 24, 35-37
10076A	High voltage probe	18, 35-37, 41
10077A	Accessory kit for 10076A	35, 41
10467-68701	0.5 mm IC clips	37, 42
10833A	GPIO cable, 1 meter	318, 322
10833B	GPIO cable, 2 meter	318, 322
10833C	GPIO cable, 4 meter	318, 322
10833D	GPIO cable, 0.5 meter	318, 322
10833F	GPIO cable, 6 meter	318, 322
10833G	GPIO cable, 8 meter	318, 322
10834A	GPIO-to-GPIO adapter	318, 322
11059A	Kelvin probe set	131, 133
11060A	Surface mount device (SMD) test probes	131
11062A	Kelvin clip set	131-133
1130A	InfiniiMax 1.5 GHz probe	27, 35, 40, 214-218
1131A	InfiniiMax 3.5 GHz probe	27, 35, 40, 214-218
1132A	InfiniiMax 5 GHz probe	35, 40, 214-218
1134A	InfiniiMax 7 GHz probe	35, 40, 214-218
1141A	200 MHz differential probe	35, 38-39
1142A	Probe control and power module	35, 38-39
1143A	Probe offset control and power module	34-35, 38
1144A	Active probe, 800 MHz	35, 38-39
1145A	2-channel, 750 MHz active probe	35, 38-39
1146A	AC/DC current probe	18, 35, 41
1147A	50 MHz/15 A AC/DC current probe with AutoProbe interface	35, 41
1153A	200 MHz 1:1 differential probe	35, 39
1156A	1.5 GHz active probe	35, 38
1157A	2.5 GHz active probe	35, 38
11581A	Coaxial attenuators set	332
11582A	Coaxial attenuators set	332
11583C	Coaxial attenuators set	332
1158A	4 GHz active probe	35, 38
1168A	10 GHz InfiniiMax II series probe amplifier	35, 40
1169A	12 GHz InfiniiMax II series probe amplifier	35, 40
11713B/C	Attenuator switch driver	328, 331
11852B	Minimum loss attenuator pad	72, 98
11853A	50-ohm Type-N accessory kit	98
11854A	50-ohm BNC accessory kit	98
11867A	Limiters	72
11878A	Type-N/3.5 mm adapter kit	98
11909A	Preamplifier	72
11930A/B	Power limiters	98
11945A	Close field probe set	72

11947A	Transient limiter	72
11970 Series	Harmonic mixers	63, 68, 72, 159
11974 Series	Preselected millimeter wave mixers	63, 68, 72
14565B	Device characterization software	223
16442B	Test fixture	169
16720A	Pattern generator module	104, 112, 115
16801A	34-channel portable logic analyzer	102
16802A	68-channel portable logic analyzer	102
16803A	102-channel portable logic analyzer	102
16804A	136-channel portable logic analyzer	102
16806A	204-channel portable logic analyzer	102
16821A	34-channel portable logic analyzer	102
16822A	68-channel portable logic analyzer	102, 112, 115
16823A	102-channel portable logic analyzer	102, 112, 115
16901A	2-slot logic analysis mainframe	103
16902B	6-slot logic analysis mainframe	103
16962A	Logic analysis module	103, 105-106

3

33521A	1-channel function/arbitrary waveform generator	209-211
33522A	2-channel function/arbitrary waveform generator	209-211
34171A/B	Input terminal connector	131
34172A/B	Input calibration short	131
34330A	30 A current shunt	131
34401A	Digital multimeter, 6½ digit	127-128, 130-131
34405A	Dual display digital multimeter, 5.5-digit	127-129
34410A	Digital multimeter, 6½ digit	127-128, 130-131
34411A	Digital multimeter, 6½ digit enhanced performance	127-128, 130
34420A	nanoVolt/micro-Ohm meter	127-128, 132
3458A	Digital multimeter, 8½ digit	127-128, 133, 176
34830A	BenchLink Data Logger Pro software	258
34901A	20-channel armature multiplexer	258-259
34902A	16-channel reed multiplexer	258-259
34903A	20-channel actuator/general purpose switch	258-259
34904A	4 x 8 two-wire matrix switch	258-259
34905A	Dual 4-channel RF multiplexer, 50 Ohms	258-259
34906A	Dual 4-channel RF multiplexer, 75 Ohms	258-259
34907A	Multifunction module	258-259
34908A	40-channel single-ended multiplexer	258-259

34921A	40-channel armature multiplexer w/ low thermal offset	261-262
34922A	70-channel armature multiplexer	262
34923A	40/80-channel reed multiplexer	262
34924A	70-channel reed multiplexer	262
34925A	40/80-channel optically isolated FET multiplexer	262
34931A	Dual 4x8 armature matrix	262
34932A	Dual 4x16 armature matrix	262
34933A	Dual/quad 4x8 reed matrix	262
34934A	Quad 4x32 reed matrix	262
34937A	28-channel Form C and 4-channel Form A	262
34938A	20-channel 5-amp Form A	262
34939A	64-channel Form A	262
34941A	Quad 1x4 50 ohm 3 GHz RF multiplexer	262
34942A	Quad 1x4 75 ohm 1.5 GHz RF multiplexer	262
34945A	Microwave switch/attenuator driver	262
34946A	Dual 1x2 SPDT terminated microwave switch	262
34947A	Triple 1x2 SPDT unterminated microwave switch	262
34950A	64-bit digital I/O with memory and counter	262
34951A	4-channel isolated D/A converter with waveform memory	262
34952A	Multifunction module with 32-bit DIO, 2-ch D/A and totalizer	262
34959A	Breadboard module	262
34970A	Data acquisition/switch unit with RS-232 and GPIO	258-259
34972A	Data acquisition/switch unit with LAN and USB	252, 258-259
34980A	Multi-function switch/measurement mainframe	252, 260-263, 293
35670A	Dynamic signal analyzer	48, 166

4

4082A	Parametric test system	176
4082F	Flash memory cell parametric test system extension	176
4083A	DC/RF parametric test system extension	176
41501B	Pulse generator and expander unit for the 4155C/4156C	171
4155C	Semiconductor parameter analyzer	167-168, 171, 240-241
4156C	Precision semiconductor parameter analyzer	167-168, 171, 174-175, 240-241
41800A	Active probe	86
4263B	LCR meter	150-151, 154
4285A	Precision LCR meter	150-151, 155
4287A	RF LCR meter	150-151, 155
42941A	Impedance probe kit	151-152
42942A	7 mm terminal adapter	151-152
4294A	Precision impedance analyzer	149, 151-152
4338B	Miliohmmeter	150, 157

4339B	High-resistance meter	150, 157
478A	Coaxial thermistor mount power sensor	137, 139

5

5000 Series	Oscilloscopes	14, 19-20, 43-44, 104
53131A	10-digit/s, 500 ps universal counter	141-143
53132A	12-digit/s, 150 ps universal counter	141-143
53147A	20 GHz counter/power meter/DVM	141, 144
53148A	26.5 GHz counter/power meter/DVM	141, 144
53149A	46 GHz counter/power meter/DVM	141, 144
53150A	20 GHz counter	141, 144
53151A	26.5 GHz counter	141, 144
53152A	46 GHz counter	141, 144
53181A	10-digit/s RF counter	141-143
53210A	350 MHz, 10-digit/s RF frequency counter	141-143
53220A	350 MHz, 12-digit/s, 100 ps universal frequency counter/timer	141-143
53230A	350 MHz, 12-digit/s, 20 ps universal frequency counter/timer	141-143
54006A	6-GHz passive divider probe	34-35, 41
54754A	Differential TDR module with dual 18 GHz TDR/electrical channels	34
5980A	3.125 Gb/s serial BERT	119, 123

6

6000 Series	Oscilloscopes	14, 22-23, 43-44, 104
6030 Series	1200 W auto-ranging single output DC power supplies	221
6540 Series	200 W single output performance DC power supplies	220
6550 Series	500 W single output performance DC power supplies	220
6570 Series	2000 W high performance DC power supplies	220
6610 Series	50 W single output performance DC power supplies	220
6620 Series	Multiple output performance DC power supplies	220, 284, 290
6630 Series	100 W single output performance DC power supplies	220
66000	Modular DC power system	220
66309B	Dual mobile communications DC source	223
66309D	Dual mobile communications DC source	223
66311B	Mobile communications DC source	223
66319B	Dual mobile communications DC source	223
66319D	Dual mobile communications DC source	223, 288-290
66321B	Mobile communications DC source with battery emulation	223
66321D	Mobile communications DC source	223

66332A	Dynamic measurement DC source, 20 V, 5 A	219, 223
6640 Series	200 W single output performance DC power supplies	220
6650 Series	500 W single output performance DC power supplies	220
6670 Series	2000 W high performance DC power supplies	220
6680 Series	5000 W high performance DC power supplies	221
6690 Series	6600 W high performance DC power supplies	221
6811B	AC power source/analyzer, 0-300 Vrms, 375 VA, single-phase	222, 235
6812B	AC power source/analyzer, 0-300 Vrms, 750 VA, single-phase	222, 235
6813B	AC power source/analyzer, 0-300 Vrms, 1750 VA, single-phase	222, 235

7

7000B Series	Oscilloscopes	24-25, 43-44
---------------------	---------------	--------------

8

81101A	Pulse generator, 50 MHz	214-217
81104A	Pulse pattern generator, 80 MHz	214-218
81110A	Pulse pattern generator, 165/330 MHz	214-218
81130A	Pulse data generator, 400/660 MHz and 1.32 Gb/s	214-218
81133A	Pulse pattern generator, 3.35 GHz, single channel	214-218
81134A	Pulse pattern generator, 3.35 GHz, dual-channel	214-218
81150A	Pulse function arbitrary noise generator	208-209, 214-218
81180A	4.2 GSa/s arbitrary waveform generator	8, 208, 213
81250	ParBERT – parallel bit error ratio tester	119, 124-125, 218
81490A	Reference transmitter	309
81495A	Reference receiver	309
8157xA	High performance modular attenuators	301
81595B	Compact modular switch	299, 304
81600B	Tunable laser modules	297, 303
8163B	Lightwave multimeter	295-296, 300
8164B	Lightwave measurement system	295-296, 300
81663A	Fixed-wavelength laser	299
8169A	Polarization controller	305
81940A	Compact tunable laser source	298
81950A	Compact tunable laser module	298
81980A	Compact tunable laser source	298
82350B	PCI GPIB interface	30, 250, 318-319
82351A	PCle–GPIB interface card	33, 250, 318-319
82357B	USB/GPIB interface	166, 250, 318, 320-321
8478B	Coaxial thermistor mount power sensor	137, 139
8480 Series	Waveguide sensors	138-139, 144

848xD Series	Diode power sensors	137-139
84904K	Programmable step attenuator	331-332
84904L	Programmable step attenuator	331-332
84904M	Programmable step attenuator	331-332
84905M	Programmable step attenuator	331-332
84906K	Programmable step attenuator	331-332
84906L	Programmable step attenuator	331-332
84907K	Programmable step attenuator	331-332
84907L	Programmable step attenuator	331-332
84908M	Programmable step attenuator	331-332
8490D	Coaxial fixed attenuator	331-332
8490G	Coaxial fixed attenuator	331-332
8491A	Coaxial fixed attenuator	331-332
8491B	Coaxial fixed attenuator	331-332
8493A	Coaxial fixed attenuator	331-332
8493B	Coaxial fixed attenuator	331-332
8493C	Coaxial fixed attenuator	331-332
8494A	Manual step attenuator	331-332
8494B	Manual step attenuator	331-332
8494G	Programmable step attenuator	331-332
8494H	Programmable step attenuator	331-332
8495A	Manual step attenuator	331-332
8495B	Manual step attenuator	331-332
8495D	Manual step attenuator	331-332
8495G	Programmable step attenuator	331-332
8495H	Programmable step attenuator	331-332
8495K	Programmable step attenuator	331-332
8496A	Manual step attenuator	331-332
8496B	Manual step attenuator	331-332
8496G	Programmable step attenuator	331-332
8496H	Programmable step attenuator	331-332
8497K	Programmable step attenuator	331-332
8498A	High power attenuator	331-332
85024A	Probe, 300 kHz to 3 GHz	72, 98
85024A	High-frequency probe	329
85331B	PIN solid state switch, 45 MHz to 50 GHz, SPDT	329
85332B	PIN solid state switch, 45 MHz to 50 GHz, SP4T	68
8564EC	Portable spectrum analyzer, 9 kHz to 40 GHz	68
8565EC	Portable spectrum analyzer, 9 kHz to 50 GHz	68
856xEC Series	Midrange spectrum analyzer	68

Product Number Index

86038B – DS091204A

86038B	Photonic dispersion and loss analyzer	303-304
86100D	DCA-X wide-bandwidth oscilloscope	9, 14, 32-34
86105C	9 GHz optical channel / 20 GHz electrical channel	34
86105D	20 GHz optical channel / 35 GHz electrical channel	34
86112A	Dual 20 GHz electrical channels	34
86115D	20 GHz multi-optical port plug-in module	34
86116C	40 to 65 GHz optical / 80 GHz electrical sampling	34
86117A	Dual 50 GHz electrical channels	34
86118A	Dual 70 GHz electrical remote sampling channels	34
86120B	Multi-wavelength meter	306
86120C	Multi-wavelength meter	306
86122A	Multi-wavelength meter	306
86142B	Optical spectrum analyzer	306
86146B	Optical spectrum analyzer	306
86205A/86207A	RF bridges	98
86213A	Attenuator set	332
87104A	SP4T, DC to 4 GHz	327
87104B	SP4T, DC to 20 GHz	327
87104C	SP4T, DC to 26.5 GHz	327
87104D	Multiport electromechanical coaxial switch	327
87106A/B/C	SP6T, DC to 4/20/26.5 GHz	327
87106D	Multiport electromechanical coaxial switch	327
87204A/B/C	SP4T, DC to 4/20/26.5 GHz	327
87206A/B/C	SP6T, DC to 4/20/26.5 GHz	327
87222C/D/E	Transfer, DC to 26.5/40/50 GHz	327
87405B/C	Preamplifiers	72
87406B	Matrix, DC to 20 GHz	327
87606B	Coaxial matrix switch	327
8762A	Coaxial switch	230-231, 326
8762B	Coaxial switch	326
8762C	Coaxial switch	326
8762F	Coaxial switch	326
8763A	4-port coaxial switch	326
8763B	4-port coaxial switch	326
8763C	4-port coaxial switch	326
8764A	5-port coaxial switch	326
8764B	5-port coaxial switch	326
8764C	5-port coaxial switch	326
8765A	Coaxial switch	326
8765B	Coaxial switch	326
8765C	Coaxial switch	326
8765D	Coaxial switch	326
8765F	Coaxial switch	326
8960 Series 10	Wireless communications test set	199, 205, 269-282, 288-289
89601A	VSA software	44, 75, 107, 111, 253, 283
89601A-200	Basic vector signal analysis software	107
89601B	VSA software	61-62

9

9000 Series	Oscilloscopes	14, 21, 26-27, 43-44, 104
90000 X-Series	Oscilloscopes	8, 14, 30-31, 43-44, 104
90000A Series	Oscilloscopes	28-29, 43-44

B

B1500A	Semiconductor device analyzer mainframe	167-171, 174-175, 240-241
B1505A	Power device analyzer/curve tracer	167-168, 170-171, 240-241
B1510A	High power source/monitor unit (HPSMU)	169-170
B1511A	Medium power source/monitor unit (MPSMU)	169
B1512A	High current source monitor unit module (HCSMU)	170
B1513A	High voltage source monitor unit module (HVSMU)	170
B1517A	High resolution source/monitor unit (HRSMU)	169
B1520A	Multi frequency capacitance measurement unit module	169-170
B1525A	High voltage semiconductor pulse generator unit (HV-SPGU)	169
B1530A	Waveform generator/fast measurement unit (WGFMU)	169
B1540A	EasyEXPERT software and measurement libraries	169
B1541A	Desktop EasyEXPERT software and measurement libraries	169
B1542A	Pulse IV package for B1500 / EasyEXPERT	169
B2200A	fA leakage switch mainframe	168, 171, 174
B2201A	14ch low leakage switch mainframe	168, 171, 174
B2210A	fA leakage switch module	174
B2211A	14ch low leakage switch module	174
B4601C	Serial-to-parallel analysis package	107
B4602A	Signal extractor tool	107
B4606A	Advanced customization environment – development and runtime package	107
B4607A	Advanced customization environment – runtime package	107
B4608A	Remote programming interface (RPI)	107
B4610A	Data import tool	23-24, 44, 107
B4621A	Bus decoder for DDR2 and DDR3	106
B4622A	DDR and LPDDR protocol compliance and analysis tool	106
B4623A	Bus decoder for LPDDR1 and LPDDR2	106
B4630A	MATLAB connectivity and analysis package	107
B4641A	Protocol development kit	107, 114
B4655A	FPGA dynamic probe for Xilinx	107
B4656A	FPGA dynamic probe for Altera	107

D

DSA90254A	2.5 GHz 4-channel oscilloscope	29
DSA90404A	4 GHz 4-channel oscilloscope	29
DSA90604A	6 GHz 4-channel oscilloscope	29
DSA90804A	8 GHz 4-channel oscilloscope	29
DSA91204A	12 GHz 4-channel oscilloscope	29
DSA91304A	13 GHz 4-channel oscilloscope	29
DSAX91604A	16 GHz signal analyzer	30-31, 40
DSAX92004A	20 GHz signal analyzer	30-31, 40
DSAX92504A	25 GHz signal analyzer	30-31, 40
DSAX92804A	28 GHz signal analyzer	30-31, 40
DSAX93204A	32 GHz signal analyzer	30-31, 40
DSO1002A	60 MHz 2-channel oscilloscope	17-18
DSO1004A	60 MHz 4-channel oscilloscope	17-18
DSO1012A	100 MHz 2-channel oscilloscope	17-18
DSO1014A	100 MHz 4-channel oscilloscope	17-18
DSO1022A	200 MHz 2-channel oscilloscope	17-18
DSO1024A	200 MHz 4-channel oscilloscope	17-18
DSO5012A	100 MHz, 2-channel portable oscilloscope	19-20
DSO5014A	100 MHz, 4-channel portable oscilloscope	19-20
DSO5032A	300 MHz, 2-channel portable oscilloscope	19-20
DSO5034A	300 MHz, 4-channel portable oscilloscope	19-20
DSO5052A	500 MHz, 2-channel portable oscilloscope	19-20
DSO5054A	500 MHz, 4-channel portable oscilloscope	19-20
DSO6012A	100 MHz 2 GSa/s oscilloscope	22-23
DSO6014A	100 MHz 2 GSa/s oscilloscope	22-23
DSO6014L	100 MHz 2 GSa/s oscilloscope	22-23
DSO6032A	300 MHz 2 GSa/s oscilloscope	22-23
DSO6034A	300 MHz 2 GSa/s oscilloscope	22-23
DSO6052A	500 MHz 4 GSa/s oscilloscope	22-23
DSO6054A	500 MHz 4 GSa/s oscilloscope	22-23
DSO6054L	500 MHz 4 GSa/s oscilloscope	22-23
DSO6102A	1 GHz 4 GSa/s oscilloscope	22-23
DSO6104A	1 GHz 4 GSa/s oscilloscope	22-23
DSO6104L	1 GHz 4 GSa/s oscilloscope	22-23
DSO7012B	100 MHz 2 GSa/s oscilloscope	24-25
DSO7014B	100 MHz 2 GSa/s oscilloscope	24-25
DSO7032B	350 MHz 2 GSa/s oscilloscope	24-25
DSO7034B	350 MHz 2 GSa/s oscilloscope	24-25
DSO7052B	500 MHz 4 GSa/s oscilloscope	24-25
DSO7054B	500 MHz 4 GSa/s oscilloscope	24-25
DSO7104B	1 GHz 4 GSa/s oscilloscope	24-25
DSO90254A	2.5 GHz 4-channel oscilloscope	28-29
DSO90404A	4 GHz 4-channel oscilloscope	28-29
DSO90604A	6 GHz 4-channel oscilloscope	28-29
DSO9064A	600 MHz 5 GSa/s oscilloscope	26-27
DSO90804A	8 GHz 4-channel oscilloscope	28-29
DSO9104A	1 GHz 10 GSa/s oscilloscope	28-29
DSO91204A	12 GHz 4-channel oscilloscope	28-29

DS091304A	13 GHz 4-channel oscilloscope	28-29
DS09254A	2.5 GHz 10 GSa/s oscilloscope	26-27
DS09404A	4 GHz 10 GSa/s oscilloscope	26-27
DSOX91604A	16 GHz digital oscilloscope	30-31
DSOX92004A	20 GHz digital oscilloscope	30-31
DSOX92504A	25 GHz digital oscilloscope	30-31
DSOX92804A	28 GHz digital signal oscilloscope	30-31
DSOX93204A	32 GHz digital signal oscilloscope	30-31

E

E1962B	cdma2000/IS-95/AMPS mobile test application	269, 279-281
E1963A	W-CDMA mobile test application	269, 277, 280-281
E1966A	1xEV-DO terminal test application	269, 278, 280-281
E1968A	GSM/GPRS mobile test application	269, 276, 280-282
E1969A	TD-SCDMA_GSM fast switch test application	269, 282
E1976A	1xEV-DO factory test mode test application	269, 278
E1987A	Fast switching test application	269, 276-281
E1991B	Mobile test application suite	269, 280
E1993A	UMTS test application suite	269, 280
E1996A	cdma2000/1xEV-DO TA suite	269, 280
E2230A	TS-5410 automotive functional test system	294
E2308A	5 k thermistor probe	131
E2613B	Wedge probe adapter	37, 42
E2614A	Wedge probe adapter	37, 42
E2615A	Wedge probe adapter	42
E2615B	Wedge probe adapter	37, 42
E2616A	Wedge probe adapter	37, 42
E2643A	Wedge probe adapter	37, 42
E2644A	Wedge probe adapter	37, 42
E2669A	InfiniiMax differential/single-ended connectivity kit	35
E2675A	Differential browser – wide span	40, 323
E2676A	Single-ended browser	40, 323
E2677A	Differential solder-in	40, 323
E2679A	Single-ended solder-in	40, 323
E2695A	Differential SMA probe head for InfiniiMax probe	40, 323
E3238S	Signal detection and monitoring solutions	118
E3610A	30 W single output power supply	222, 236-237
E3611A	30 W single output power supply	237
E3612A	30 W single output power supply	222, 237
E3614A	48 W single output power supply	222, 236-237
E3615A	60 W single output power supply	237
E3616A	60 W single output power supply	237

E3617A	60 W single output power supply	222, 237
E3620A	50 W dual output power supply	222, 236-237
E3630A	30 W triple output power supply	222, 236-237
E3631A	80 W triple output power supply	222, 236, 238
E3632A	120 W single output power supply	222, 236, 238
E3633A	200 W single output power supply	238
E3634A	200 W single output power supply	222, 238
E3640A	30 W single output power supply	222, 236, 239
E3641A	30 W single output power supply	222, 239
E3642A	50 W single output power supply	222, 239
E3643A	50 W single output power supply	222, 239
E3644A	80 W single output power supply	222, 239
E3645A	80 W single output power supply	222, 236, 239
E3646A	60 W dual output power supply	222, 236, 239
E3647A	60 W dual output power supply	222, 239
E3648A	100 W dual output power supply	222, 239
E3649A	100 W dual output power supply	222, 236, 239
E4360A	Modular solar array simulator mainframe, 1200 W	224-225
E4361A	Solar array simulator DC module 65 V, 8.5 A, 510 W	219, 224-225
E4362A	Solar array simulator DC module 130 V, 5 A, 600 W	219, 224-225
E4402B	ESA-E spectrum analyzer, 100 Hz to 3.0 GHz	65-67
E4402B-STD	ESA-E standard spectrum analyzer, 9 kHz to 3.0 GHz	65-67
E4404B	ESA-E spectrum analyzer, 100 Hz to 6.7 GHz	65-67
E4404B-STD	ESA-E standard spectrum analyzer, 9 kHz to 6.7 GHz	65-67
E4405B	ESA-E spectrum analyzer, 100 Hz to 13.2 GHz	65-67
E4405B-STD	ESA-E standard spectrum analyzer, 9 kHz to 13.2 GHz	65-67
E4407B	ESA-E spectrum analyzer, 100 Hz to 26.5 GHz	65-67, 72
E4407B-STD	ESA-E standard spectrum analyzer, 9 kHz to 26.5 GHz	65-67
E4411B	ESA-L spectrum analyzer, 1 MHz to 1.5 GHz	65-67
E4411B-BAS	ESA-L basic spectrum analyzer, 9 kHz to 1.5 GHz	65-67
E4416A	EPM-P Series power meters	137-138
E4417A	EPM-P Series power meters	137-138
E441xA	E-Series diode power sensors	137-139

E4428C	Analog signal generator	178, 180, 187-188, 190, 192, 202, 207
E4428C-503	Analog signal generator, 250 kHz to 3 GHz	188
E4428C-506	Analog signal generator, 250 kHz to 6 GHz	188
E4438C	ESG RF vector signal generator	178-179, 190, 192, 194, 199-200, 202, 204, 206-207, 288
E4438C-407	Signal Studio for S-DMB	203-204
E4438C-419	Signal Studio for 3GPP W-CDMA HSPA	203-204
E4438C-501	ESG RF vector signal generator, 250 kHz to 1 GHz	200
E4438C-502	ESG RF vector signal generator, 250 kHz to 2 GHz	200
E4438C-503	ESG RF vector signal generator, 250 kHz to 3 GHz	200
E4438C-504	ESG RF vector signal generator, 250 kHz to 4 GHz	200
E4438C-506	ESG RF vector signal generator, 250 kHz to 6 GHz	200
E4438C-SP1	Signal Studio for jitter injection	203-204
E4440A	PSA Series spectrum analyzer, 3 Hz to 26.5 GHz	63-64, 72
E4443A	PSA Series spectrum analyzer, 3 Hz to 6.7 GHz	63-64
E4445A	PSA Series spectrum analyzer, 3 Hz to 13.2 GHz	63-64, 288-289
E4446A	PSA Series spectrum analyzer, 3 Hz to 44 GHz	63-64
E4447A	PSA Series spectrum analyzer, 3 Hz to 42.98 GHz	63-64
E4448A	PSA Series spectrum analyzer, 3 Hz to 50 GHz	63-64
E444xA-239	PSA spectrum analyzer with EMI personality	116
E4805B	Clock module	124-125
E4808A	Clock module	124-125
E4809A	Clock module	124-125
E4832A	Data modules	124-125, 218
E4835A	Data modules	124-125, 218
E4838A	Data modules	124-125, 218
E4861B	Data modules	124-125, 218
E4980A	Precision LCR meter	150-151, 154, 176
E4981A	Capacitance meter	150-151, 156
E4991A	RF impedance/material analyzer	149, 151, 153
E5052B	10 MHz to 7 GHz signal source analyzer	48, 150, 159, 323
E5053A	3 GHz to 26.5 GHz microwave downconverter	48, 159
E5061A	Network analyzer, 300 kHz to 1.5 GHz	81-82, 87, 323
E5061B	Network analyzer	6, 81-82, 85-86, 323
E5061B-3L5	LF-RF network analyzer with DC bias source, 5 Hz to 3 GHz	6, 81, 86
E5062A	Network analyzer, 300 kHz to 3 GHz	81-82, 87
E5071C	ENA network analyzer	6, 81-84, 96, 323

Product Number Index

E5092A – L4445A

E5092A	Configurable multiport test set	84
E5250A	Low leakage switch mainframe	168, 171, 175
E5252A	10 x 12 matrix card	175
E5255A	24 channel multiplexer card	175
E5260A	8 slot high speed measurement mainframe	167-168, 172, 240-241
E5262A	2 channel (medium power, medium power) SMU	167-168, 172, 241
E5263A	2 channel (high power, medium power) SMU	167-168, 172, 241
E5270B	8 slot precision measurement mainframe	167-168, 173-175, 240-241
E5280B	Precision high power SMU module	173
E5281B	Precision medium power SMU module	173
E5287B	High resolution SMU module	173
E5288A	Atto sense and switch unit (ASU)	169, 173
E5290A	High speed type high power SMU module	172
E5291A	High speed type medium power SMU module	172
E5346A	Mictor probe	105
E5378A	Samtec probe	105, 112, 115
E5379A	Samtec probe	105, 112
E5380A	Mictor probe	105
E5381A	Flying lead probe	105, 112, 115
E5382A	Flying lead probe	105
E5383A	Flying lead set	105
E5385A	Samtec probe	105, 112, 115
E5387A	Soft touch connectorless probe	105, 112, 115
E5390A	Soft touch connectorless probe	105
E5394A	Soft touch connectorless probe	105
E5396A	Half-size soft touch connectorless probe	105
E5398A	Half-size soft touch connectorless probe	105
E5402A	Low-profile pro Series soft touch connectorless probe	105
E5404A	Pro Series soft touch connectorless probe	105
E5405A	Pro Series soft touch connectorless probe	105, 112, 115
E5406A	Pro Series soft touch connectorless probe	105
E5515C	Wireless communications test set	205, 269-272, 274, 276-279, 282, 288-289
E5805A	USB/4-port RS-232 interface	250, 318, 320-321
E5810A	LAN/GPIB gateway	250, 318, 321
E5813A	Networked 5-port USB hub	250, 318, 321
E6567C	cdma2000, IS-95, AMPS, 1xEV-DO Wireless Test Manager	269, 275, 278-279, 281
E6568C	W-CDMA, GSM, GPRS, and EGPRS Wireless Test Manager	269, 275-277, 281

E6569C	Wireless Test Manager Suite	269, 275, 280-281
E6584A	Wireless protocol advisor software	274
E6607A-503	EXT non-signaling wireless test set, 10 MHz to 3.6 GHz	285
E6607A-506	EXT non-signaling wireless test set, 10 MHz to 6.0 GHz	285
E6621A	PXT wireless communications test set	284, 290
E6621A-503	PXT wireless communications test set, 500 MHz to 3.0 GHz	284
E6621A-506	PXT wireless communications test set, 500 MHz to 6.0 GHz	284
E6651A	Mobile WiMAX test set	286
E6651A-503	Mobile WiMAX test set, 450 MHz to 2.7 GHz	286
E6651A-506	Mobile WiMAX test set, 450 MHz to 6 GHz	286
E6701H	GSM/GPRS lab application	269-270
E6702D	cdma2000 lab application	269, 272
E6703G	W-CDMA/HSPA lab application	269, 271, 273
E6704A	EGPRS lab application	269-270
E6705A	GSM/GPRS/EGPRS encryption functionality for mobile test	270
E6706D	1xEV-DO lab application	269, 272
E6715A	W-CDMA/HSPA encryption	271
E6720A	Lab application annual contract	270-273
E8257D	PSG microwave analog signal generator 4, 178, 180-184, 207, 288	
E8257D-520	PSG microwave analog signal generator, 250 kHz to 20 GHz	183
E8257D-521	PSG microwave analog signal generator, 10 MHz to 20 GHz	183
E8257D-532	PSG microwave analog signal generator, 250 kHz to 31.8 GHz	183, 198
E8257D-540	PSG microwave analog signal generator, 250 kHz to 40 GHz	183
E8257D-550	PSG microwave analog signal generator, 250 kHz to 50 GHz	183
E8257D-567	PSG microwave analog signal generator, 250 kHz to 67 GHz	183
E8257D-S02	WR-02 source module	184
E8257D-S03	WR-03 source module	184
E8257D-S05	WR-05 source module	184
E8257D-S06	WR-06 source module	184
E8257D-S08	WR-08 source module	184
E8257D-S10	WR-10 source module	184
E8257D-S12	WR-12 source module	184
E8257D-S15	WR-15 source module	184
E8267D	PSG vector signal generator 4, 8, 178-179, 184, 194-198, 204, 206-207	
E8267D-520	PSG vector signal generator, 250 kHz to 20 GHz	198
E8267D-544	PSG vector signal generator, 250 kHz to 44 GHz	198
E8267D-SP1	Signal Studio for jitter injection	203-204

E8311A	Pulse pattern generator, 165 MHz VXI C-1	214-217
E8312A	Pulse pattern generator, 330 MHz VXI C-1	214-217
E8361C	Network analyzer, 10 MHz to 67 GHz	81-82, 88-90, 93
E8362C	Network analyzer, 10 MHz to 20 GHz	81-82, 90, 93, 176
E8363C	Network analyzer, 10 MHz to 40 GHz	81-82, 90, 93, 117
E8364C	Network analyzer, 10 MHz to 50 GHz	81-82, 90, 93, 117
E8663D	PSG RF analog signal generator 4, 178, 180, 185-186, 207	
E8663D-503	PSG RF analog signal generator, 100 kHz to 3.2 GHz	186
E8663D-509	PSG RF analog signal generator, 100 kHz to 9 GHz	186
E8780B	TS-5400 Series II automotive functional test system (ExpressConnect)	294
E8786B	TS-5400 Series II automotive functional test system (MAC panel)	294
E9300	E-Series diode power sensors	138-139
E9320	E-Series diode power sensors	138
E9524A	MicroBlaze	107
E9528A	ARM Cortex ETM decoder	107
E9529A	ARM Cortex PTM decoder	107
E9821A	Signal processor module for E3238 system	118
E9901E	1-module in-circuit test system, i327x Series 5	291
E9902E	2-module in-circuit test system, i307x Series 5	291
E9903E	4-module in-circuit test system, i307x Series 5	291
E9905E	2-module in-circuit test system, i307x Series 5	291

G

GS-8800	RF design verification and conformance test system	270-272, 288-290
----------------	--	------------------

J

J7211A	Attenuation control unit, DC to 6 GHz, 0 to 121 dB	330
J7211B	Attenuation control unit, DC to 18 GHz, 0 to 121 dB	330
J7211C	Attenuation control unit, DC to 26.5 GHz, 0 to 101 dB	330

L

L4400 Series	LXI instruments	263
L4411A	System digital multimeter, 6½ digit high performance	127-128, 130
L4421A	40 Channel armature mux	263
L4433A	Dual 4x8 reed matrix	263
L4437A	28 Channel Form C, 4 Channel Form A	263
L4445A	Microwave switch/attenuator driver	263

L4450A	64-bit digital I/O with memory and counter	263
L4451A	4-channel isolated D/A converter with memory	263
L4452A	Multifunction module	263
L4490A	2U RF switch platform	333
L4491A	4U RF switch platform	333
L4532A	2 channel 20 MSa/s digitizer	164-165
L4534A	4 channel 20 MSa/s digitizer	164-165
L7104A	DC to 4 GHz, SP4T, terminated	328
L7104B	DC to 20 GHz, SP4T, terminated	328
L7104C	DC to 26.5 GHz, SP4T, terminated	328
L7106A	DC to 4 GHz, SP6T, terminated	328
L7106B	DC to 20 GHz, SP6T, terminated	328
L7106C	DC to 26.5 GHz, SP6T, terminated	328
L7204A	DC to 4 GHz, SP4T, unterminated	328
L7204B	DC to 20 GHz, SP4T, unterminated	328
L7204C	DC to 26.5 GHz, SP4T, unterminated	328
L7206A	DC to 4 GHz, SP6T, unterminated	328
L7206B	DC to 20 GHz, SP6T, unterminated	328
L7206C	DC to 26.5 GHz, SP6T, unterminated	328
L7222C	DC to 26.5 GHz transfer switch	328

M

M9018A	18 slot PXIe chassis	2, 253, 256
M9021A	PXIe system interface	256
M9045A	PCIe ExpressCard adaptor	256
M9101A	PXI high-density multiplexe	255, 267-268
M9102A	PXI high-density multiplexer	255, 267-268
M9103A	PXI high-density multiplexer	255, 267-268
M9120A	PXI matrix switch	255, 267-268
M9121A	PXI matrix switch	255, 267-268
M9122A	PXI matrix switch	255, 267-268
M9128A	PXI RF matrix switch	256, 267-268
M9130A	PXI SPDT switch	255, 267-268
M9131A	PXI SPDT switch	255, 267-268
M9132A	PXI SPDT switch	255, 267-268
M9133A	PXI SPDT switch	255, 267-268
M9135A	PXI SPDT switch	255, 267-268
M9146A	PXI RF multiplexer	256, 267-268
M9147A	PXI RF multiplexer	256, 267-268
M9148A	PXI RF multiplexer	256, 267-268
M9149A	PXI RF multiplexer	256, 267-268
M9150A	PXI RF multiplexer	256, 267-268
M9151A	PXI RF multiplexer	256, 267-268
M9152A	PXI RF multiplexer	256, 267-268
M9153A	PXI RF multiplexer	256, 267-268
M9155C	PXI hybrid dual SPDT coaxial switch	256, 267-268, 324

M9156C	PXI hybrid dual transfer switch	256, 267-268, 324
M9157C	PXI Hybrid Single SP6T Switch	256, 267-268, 324
M9182A	Digital multimeter, 6.5 digit, PXI	254
M9183A	Digital multimeter, 6 1/2 digit, PXI	254
M9186A	PXI isolated single channel voltage/current source	255
M9187A	PXI Digital IO	254
M9202A	PXIe IF digitizer: 12-bit, 2 GS/s, 1 GHz	2, 75-77, 162-163, 254
M9210A	PXI-H high-speed digitizer scope: 10-bit, 2 – 4 GS/s, 1.4 GHz	162, 254
M9211A	PXI-H high-speed wideband IF digitizer: 10-bit, 4 GS/s, 3 GHz	162-163, 254
M9302A	PXI local oscillator: 3 – 10 GHz	2, 75-77, 163, 254-255
M9330A	15-bit, 1.25 GS/s arbitrary waveform generator	209, 212, 254
M9331A	10-bit, 1.25 GS/s arbitrary waveform generator	212, 254
M9351A	PXI downconverter: 50 MHz – 2.9 GHz	2, 75-77, 254-255
M9360A	PXI attenuator/preselector: 100 kHz – 26.5 GHz	2, 75-77, 254-255
M9361A	PXI downconverter: 2.75 MHz – 26.5 GHz	2, 75-77, 163, 254-255
M9392A	PXI vector signal analyzer: 50 MHz – 26.5 GHz	2, 75-77, 163, 254
MSO6012A	100 MHz 2 GSa/s oscilloscope	22-23
MSO6014A	100 MHz 2 GSa/s oscilloscope	22-23
MSO6032A	300 MHz 2 GSa/s oscilloscope	22-23
MSO6034A	300 MHz 2 GSa/s oscilloscope	22-23
MSO6052A	500 MHz 4 GSa/s oscilloscope	22-23
MSO6054A	500 MHz 4 GSa/s oscilloscope	22-23
MSO6102A	1 GHz 4 GSa/s oscilloscope	22-23
MSO6104A	1 GHz 4 GSa/s oscilloscope	22-23
MSO7012B	100 MHz 2 GSa/s oscilloscope	24-25
MSO7014B	100 MHz 2 GSa/s oscilloscope	24-25
MSO7032B	350 MHz 2 GSa/s oscilloscope	24-25
MSO7034B	350 MHz 2 GSa/s oscilloscope	24-25
MSO7052B	500 MHz 4 GSa/s oscilloscope	24-25
MSO7054B	500 MHz 4 GSa/s oscilloscope	24-25
MSO7104B	1 GHz 4 GSa/s oscilloscope	24-25
MSO9064A	600 MHz 5 GSa/s oscilloscope	26-27
MSO9104A	1 GHz 10 GSa/s oscilloscope	26-27
MSO9254A	2.5 GHz 10 GSa/s oscilloscope	26-27
MSO9404A	4 GHz 10 GSa/s oscilloscope	26-27

N

N1258A	Module selector	170
N1259A	Test fixture for power device	170
N1260A	High voltage bias-T	170
N1261A	Protection adapter	170
N1262A	R-box	170
N1301A	CMU accessories for B1500	169
N1810TL	Coaxial switch	325
N1810UL	Coaxial switch	325
N1811TL	4-port coaxial switch	325

N1812UL	5-port coaxial switch	325
N1911A	P-Series power meter	64, 137-139
N1912A	P-Series power meter	64, 137-139
N1913A	EPM Series power meters	137, 139
N1914A	EPM Series power meters	137, 139
N1921A/ N1922A	P-Series wideband diode sensors	137-138
N1930A	Physical-layer test system software	117
N1955B	E8363C PNA and N4420B test set 4-Port/4-Receiver	117
N1957B	E8364C PNA and N4421B test set 4-Port/4-Receiver	117
N1958B	N5230C PNA-L with built-in test set	117
N1960A	GS-8800 design verification system	288-289
N2002A	Noise source test set	147-148
N2100B	PXIT 10.3125 Gb/s digital communications analyzer	126, 254
N2101B	PXIT 10.3125 Gb/s Bit Error Ratio Tester	119, 126, 255-256
N2102B	PXIT 10.3125 Gb/s pattern generator	126, 218, 254-255
N2771A	High voltage probe	18, 35, 41
N2779A	3-channel power supply for N2780A Series current probes	35, 41
N2780A	AC/DC current probe	41
N2781A	AC/DC current probe	41
N2782A	AC/DC current probe	41
N2783A	AC/DC current probe	27, 35, 41
N2784A	1-positioning arm probe positioner	42, 323
N2785A	2-positioning arm probe positioner	42, 323
N2786A	2-legged probe positioner	36, 42
N2787A	3D probe positioner	42, 323
N2790A	100 MHz, 1.4 kV differential probe with AutoProbe interface	20, 35, 39
N2791A	25 MHz, 700 V differential probe	20, 35, 39
N2792A	200 MHz, 20 V differential probe	20, 35, 39
N2793A	800 MHz, 15 V differential probe	20, 35, 39
N2795A	1 GHz active probes	35, 38
N2796A	2 GHz active probes	35, 38
N2800A	16 GHz InfiniiMax III Series probe amplifier	30, 40
N2801A	20 GHz InfiniiMax III Series probe amplifier	30, 40
N2802A	25 GHz InfiniiMax III Series probe amplifier	30, 40
N2803A	30 GHz InfiniiMax III Series probe amplifier	30, 40
N2862A	Passive probe	18, 35-37, 42
N2863A	Passive probe	18, 20, 35-37
N2874A	Passive probe	35-37
N2875A	Passive probe	36-37
N2876A	Passive probe	35-37
N2880A	In-line attenuator kit	40, 323
N2881A	DC blocking capacitor	40, 323

Product Number Index

N2891A – N5771A

N2891A	70 MHz, 7,000 V differential probe 35, 39	N4906B-101	Differential analysis, fast eye mask and enhanced measurement suite 122	N5381A	12 GHz InfiniiMax differential solder- in probe head 40, 323
N3300A	1800 W DC electronic load mainframe 222, 232-234	N4906B-102	Extension to full frequency range 150 Mb/s to 12.5 Gb/s + clock data recovery 122	N5382A	InfiniiMax II 12 GHz differential browser 40, 323
N3301A	600 W half rack width DC electronic load mainframe 222, 232-233	N4916B	4-tap de-emphasis signal converter 119, 121	N5425A	12 GHz InfiniiMax differential ZIF probe head 40, 323
N3302A	150 W DC electronic load module 233	N4917A	Optical receiver stress test solution 119, 309	N5426A	12 GHz InfiniiMax ZIF tip – kit of 10 40, 323
N3303A	250 W DC electronic load module 233	N5102A	Digital signal interface module 178-179, 198-200, 206	N5439A	InfiniiMax III ZIF probe head 30, 40
N3304A	300 W DC electronic load module 233	N5106A	PXB baseband generator and channel emulator 178-179, 199, 204-206, 209	N5441A	InfiniiMax III Solder-in probe head 30, 40
N3305A	500 W DC electronic load module 233	N5181A	MXG RF analog signal generator 116, 178, 180, 189-190, 207	N5444A	InfiniiMax III 2.92 mm/3.5 mm/SMA probe head 30, 40
N3306A	600 W DC electronic load module 232-233	N5181A-501	MXG RF analog signal generator, 100 kHz to 1 GHz 190	N5445A	InfiniiMax III browser head 30, 40
N3307A	250 W DC electronic load module 232-233	N5181A-503	MXG RF analog signal generator, 100 kHz to 3 GHz 190	N5450A	InfiniiMax extreme temperature cable extension 40, 323
N4000A	SNS Series noise source, 10 MHz to 18 GHz, nominal ENR 6 dB 147	N5181A-506	MXG RF analog signal generator, 100 kHz to 6 GHz 190	N5700 Series	750 W to 1500 W low profile single output dc power supplies 221, 230-231
N4001A	SNS Series noise source, 10 MHz to 18 GHz, nominal ENR 15 dB 147	N5182A	MXG RF vector signal generator 179, 194, 201-202, 204, 207	N5741A	DC system power supply, 6 V, 100 A, 600 W 230-231
N4002A	SNS Series noise source, 10 MHz to 26.5 GHz, nominal ENR 15 dB 147	N5182A-503	MXG RF vector signal generator, 100 kHz to 3 GHz 202	N5742A	DC system power supply, 8 V, 90 A, 720 W 230-231
N4010A	Wireless connectivity test set 283	N5182A-506	MXG RF vector signal generator, 100 kHz to 6 GHz 202	N5743A	DC system power supply, 12.5 V, 60 A, 750 W 230-231
N4019C	Bluetooth and WLAN Wireless Test Manager 275, 283	N5183A	MXG microwave analog signal generator 178, 180, 191-192	N5744A	DC system power supply, 20 V, 38 A, 760 W 230-231
N4241A	PCIe mid-bus probe for PCIe 5 Gb/s 109-110	N5183A-520	MXG microwave analog signal generator, 100 kHz to 20 GHz 192	N5745A	DC system power supply, 30 V, 25 A, 750 W 230-231
N4241F	PCIe flying leads probe for PCIe 5 Gb/s 109-110	N5183A-532	MXG microwave analog signal generator, 100 kHz to 31.8 GHz 192	N5746A	DC system power supply, 40 V, 19 A, 760 W 230-231
N4241Z	PCIe flying leads probe for PCIe 5 Gb/s 109-110	N5183A-540	MXG microwave analog signal generator, 100 kHz to 40 GHz 192	N5747A	DC system power supply, 60 V, 12.5 A, 750 W 230-231
N432A	Thermistor power meter 137, 139	N5230C	Network analyzer 81-82, 88-89, 91, 94, 117	N5748A	DC system power supply, 80 V, 9.5 A, 760 W 230-231
N4371A	RIN measurement system 309	N5241A	Network analyzer, 10 MHz to 13.5 GHz 82, 88-90, 92	N5749A	DC system power supply, 100 V, 7.5 A, 750 W 230-231
N4373C	Lightwave component analyzer 308	N5242A	Network analyzer, 10 MHz to 26.5 GHz 82, 88-90, 92	N5750A	DC system power supply, 150 V, 5 A, 750 W 230-231
N4374B	Lightwave component analyzer 308	N5244A	Network analyzer, 10 MHz to 43.5 GHz 82, 88-90, 92	N5751A	DC system power supply, 300 V, 2.5 A, 750 W 230-231
N4375B	Lightwave component analyzer 308	N5245A	Network analyzer, 10 MHz to 50 GHz 82, 88-90, 92	N5752A	DC system power supply, 600 V, 1.3 A, 780 W 230-231
N4376B	Lightwave component analyzer 308	N5247A	Network analyzer, 10 MHz to 67 GHz 5, 7, 82, 88-90, 92	N5761A	DC system power supply, 6 V, 180 A, 1080 W 230-231
N4391A	Optical modulation analyzer 307	N5250C	Network analyzer, 10 MHz to 110 GHz 81-82, 88-90, 93	N5762A	DC system power supply, 8 V, 165 A, 1320 W 230-231
N4850A	DigRFv3 digital acquisition probe 111-112	N5302A	2-slot, 2U high chassis 112	N5763A	DC system power supply, 12.5 V, 120 A, 1500 W 230-231
N4851B	MIPI D-PHY 4 lane digital acquisition probe 114-115	N5304A	4-slot, 2U high chassis 112	N5764A	DC system power supply, 20 V, 76 A, 1520 W 230-231
N4860A	DigRFv3 digital stimulus probe 111-112	N5306A	PCIe analyzer for PCIe 5 Gb/s 109-110	N5765A	DC system power supply, 30 V, 50 A, 1500 W 230-231
N4861B	MIPI D-PHY 3 lane digital stimulus probe 114-115	N5309A	PCIe exerciser & PCIe LTSSM tester for PCIe 5 Gb/s 109-110	N5766A	DC system power supply, 40 V, 38 A, 1520 W 230-231
N4872A	Data generator front ends 124-125, 218	N5315A	PCIe slot interposer probe for PCIe 5 Gb/s 109-110	N5767A	DC system power supply, 60 V, 25 A, 1500 W 230-231
N4873A	Data analyzer modules 124-125, 218	N5343A	DigRF exerciser module 111-112, 204	N5768A	DC system power supply, 80 V, 19 A, 1520 W 230-231
N4874A	Data generator modules 124-125, 218	N5344A	DigRF analyzer module 111-112	N5769A	DC system power supply, 100 V, 15 A, 1500 W 230-231
N4875A	Data analyzer modules 124-125, 218	N5345A	Soft touch mid bus probe 112	N5770A	DC system power supply, 150 V, 10 A, 1500 W 230-231
N4876A-001	28 Gb/s multiplexer 2 : 1 121	N5346A	Flying leads 112	N5771A	DC system power supply, 300 V, 5 A, 1500 W 230-231
N4903B	J-BERT high-performance serial BERT up to 7 and 12.5 Gb/s 119-121, 218	N5380A	InfiniiMax II 12 GHz differential SMA adapter 40, 323		
N4906B-003	Serial BERT 3.6 Gb/s pattern generator and error detector; 4 x 50 Ω terminations 122				
N4906B-012	Serial BERT 12.5 Gb/s; pattern generator and error detector 122				

N5772A	DC system power supply, 600 V, 2.6 A, 1560 W	230-231
N5880A	cdma2000/IS-95/AMPS enhanced Wireless Test Manager	269, 275
N5882A	W-CDMA enhanced Wireless Test Manager	269, 275
N5884A	1xEV-DO enhanced Wireless Test Manager	269, 275
N5970A	UMTS interactive functional test software	269-271, 274
N5971A	CDMA interactive functional test software	269, 272, 274
N5990A	Test automation software	119
N5998A	HDMI 1.3 protocol/audio/video analyzer and generator	113
N6050A	LTE mobile test software	284
N6050A-7FP	LTE FDD base station emulation	284
N6051A	LTE parametric test with test mode signaling	284
N6051A-1FP	LTE RF Tx and Rx measurements	284
N6052A	LTE functional and application test	284
N6052A-1FP	LTE enhanced BSE and IP data test	284
N6061A	Protocol logging and analysis	284
N6061A-1TP	LTE protocol logging and analysis	284
N6062A	Protocol message editor	284
N6062A-1TP	LTE message editor	284
N6072A	LTE signaling conformance adapters and test cases	284
N6075A	LTE signaling conformance test suite	284
N6301A	802.16 OFDMA measurement application	287
N6302A	WLAN measurement applications	287
N6700	Low profile modular DC power system	10, 219-220, 226-229, 240-241
N6700B	Low profile modular power system mainframe, 400 W	220, 226-227
N6701A	Low profile modular power system mainframe, 600 W	220, 226-227
N6702A	Low profile modular power system mainframe, 1200 W	220, 226-227, 240
N6705	DC power analyzer	220, 226-228, 240
N6705B	DC power analyzer, modular, 600 W	10, 220, 226-227, 229, 240-241
N673xB	N6700 DC power modules, 50 W	226-227
N674xB	N6700 DC power modules, 100 W	226-227
N675xA	N6700 DC power modules, performance	226-227
N676xA	N6700 DC power modules, precision	226-227
N677xA	N6700 DC power modules, 300 W	226-227
N6781A	2-quadrant source measure unit for battery drain analysis	10, 219, 226-229, 241
N6782A	2-quadrant source measure unit for functional test	10, 219, 226-229, 241

N6784A	4-quadrant general purpose source measure unit	10, 219, 226-229, 241
N678xA	N6700 source measure units	226
N6820E	E3238S signal survey software	12, 118
N6830A	Dual channel HF receiver and 70 MHz IF ADC for E3238 systems	118
N6841A	RF sensor	12, 118
N7105A	Signal monitoring system	12, 118
N7300A	Serials chipset software for WiMax/WLAN/ <i>Bluetooth</i> test	287
N7600B	Signal Studio for 3GPP W-CDMA FDD	203-204, 285
N7601B	Signal Studio for 3GPP2 CDMA	203-204, 285
N7602B	Signal Studio for GSM/EDGE	203-204, 285
N7606B	Signal Studio for <i>Bluetooth</i>	203-204, 285
N7609B	Signal Studio for global navigation satellite systems	203-204
N7611B	Signal Studio for broadcast radio	203-204, 285
N7612B	Signal Studio for TD-SCDMA	203-204
N7613A	Signal Studio for 802.16-2004 (WiMAX)	203-204
N7616B	Signal Studio for T-DMB	203-204, 285
N7617B	Signal Studio for 802.11 WLAN	203-204, 285
N7619A	Signal Studio for Multiband OFDM UWB	203-204
N7620A	Signal Studio for pulse building	203-204
N7621A	Signal Studio for multitone distortion	203-204
N7621B	Signal Studio for multitone distortion	203-204
N7622A	Signal Studio Toolkit	203-204
N7623B	Signal Studio for digital video	203-204
N7624B	Signal Studio for 3GPP LTE FDD	203-204, 285
N7625B	Signal Studio for 3GPP LTE TDD	203-204
N7700A	Photonic application suite	295-296, 301, 305
N7711A	Tunable laser source 1 port	298
N7714A	Tunable laser source 4 ports	298
N7744A	Multiport power meter	300-301
N7745A	Multiport power meter	301
N7751A	Integrated one channel variable optical attenuator	302
N7752A	Integrated one channel variable optical attenuator	302
N7761A	One-channel variable optical attenuator	302
N7762A	Two-channel variable optical attenuator	302
N7764A	Four-channel variable optical attenuator	302
N7768A	Four-channel multimode optical attenuator	302

N7781A	Polarization analyzer	303-304
N7782B	PER analyzer	303-304
N7783B	Thermal cycling unit	303-304
N7784B	Polarization controller	305
N7785B	Synchronous scrambler	305
N7786B	Polarization synthesizer	305
N7788B	Optical component analyzer	303-304
N8201A	Performance downconverter	78
N8211A	Performance analog upconverter	78
N8212A	Performance vector upconverter	78
N8221A	IF digitizer	78
N8241A	15-bit arbitrary waveform generator	78, 209, 212
N8242A	10-bit arbitrary waveform generator	78, 209, 212
N8262A	P-Series modular power meter	137-139
N8300A	Wireless networking test set	204, 287
N8300A-404	Wireless networking test set MIMO/multi-port connectivity	287
N8300A-505	Wireless networking test set, frequency range to 4.8 GHz	287
N8300A-506	Wireless networking test set, frequency range to 6.0 GHz	287
N8480 Series	Thermocouple power sensors	137-139
N8700 Series	3300 W to 5000 W low profile single output dc power supplies	221, 230-231
N8731A	DC system power supply, 8 V, 400 A, 3200 W	230-231
N8732A	DC system power supply, 10 V, 330 A, 3300 W	230-231
N8733A	DC system power supply, 15 V, 220 A, 3300 W	230-231
N8734A	DC system power supply, 20 V, 165 A, 3300 W	230-231
N8735A	DC system power supply, 30 V, 110 A, 3300 W	230-231
N8736A	DC system power supply, 40 V, 85 A, 3400 W	230-231
N8737A	DC system power supply, 60 V, 55 A, 3300 W	230-231
N8738A	DC system power supply, 80 V, 42 A, 3360 W	230-231
N8739A	DC system power supply, 100 V, 33 A, 3300 W	230-231
N8740A	DC system power supply, 150 V, 22 A, 3300 W	230-231
N8741A	DC system power supply, 300 V, 11 A, 3300 W	230-231
N8742A	DC system power supply, 600 V, 5.5 A, 3300 W	230-231
N8754A	DC system power supply, 20 V, 250 A, 5000 W	230-231
N8755A	DC system power supply, 30 V, 170 A, 5100 W	230-231
N8756A	DC system power supply, 40 V, 125 A, 5000 W	230-231
N8757A	DC system power supply, 60 V, 85 A, 5100 W	230-231
N8758A	DC system power supply, 80 V, 65 A, 5200 W	230-231

Product Number Index

N8759A – U2781A

N8759A	DC system power supply, 100 V, 50 A, 5000 W	230-231
N8760A	DC system power supply, 150 V, 34 A, 5100 W	230-231
N8761A	DC system power supply, 300 V, 17 A, 5100 W	230-231
N8762A	DC system power supply, 600 V, 8.5 A, 5100 W	230-231
N8973A	NFA Series noise figure analyzer, 10 MHz to 3.0 GHz	145-146
N8974A	NFA Series noise figure analyzer, 10 MHz to 6.7 GHz	145-146
N8975A	NFA Series noise figure analyzer, 10 MHz to 26.5 GHz	145-146, 148
N8993A	GS-8800 Series (8960) wireless communication design verification benchtop systems	288-289
N9000A	CXA signal analyzer	46, 56-60, 74, 116
N9000A-503	CXA signal analyzer, 9 kHz to 3.0 GHz	56, 58
N9000A-507	CXA signal analyzer, 9 kHz to 7.5 GHz	56, 58
N9010A	EXA signal analyzer	46, 53-55, 59-60, 74, 116
N9010A-503	EXA signal analyzer, 9 kHz to 3.6 GHz	55
N9010A-507	EXA signal analyzer, 9 kHz to 7.0 GHz	55
N9010A-513	EXA signal analyzer, 9 kHz to 13.6 GHz	55
N9010A-526	EXA signal analyzer, 9 kHz to 26.5 GHz	55
N9020A	MXA signal analyzer	46, 52-53, 59-60, 68, 74, 116, 290, 323
N9020A-503	MXA signal analyzer, 20 Hz to 3.6 GHz	53
N9020A-508	MXA signal analyzer, 20 Hz to 8.4 GHz	53
N9020A-513	MXA signal analyzer, 20 Hz to 13.6 GHz	53
N9020A-526	MXA signal analyzer, 20 Hz to 26.5 GHz	53
N9030A	PXA signal analyzer	46, 49-51, 59-60, 74, 116, 323
N9030A-503	PXA signal analyzer, 3 Hz to 3.6 GHz	51
N9030A-508	PXA signal analyzer, 3 Hz to 8.4 GHz	51
N9030A-513	PXA signal analyzer, 3 Hz to 13.6 GHz	51
N9030A-526	PXA signal analyzer, 3 Hz to 26.5 GHz	51
N9039A	RF preselector	48, 63, 116
N9310A	RF signal generator	69, 178, 180, 193-194
N9320B	RF spectrum analyzer, 9 kHz - 3 GHz	46-47, 69, 74
N9340B	Handheld spectrum analyzer (HSA)	3, 46, 70-71, 74
N9342C	Handheld spectrum analyzer (HSA)	3, 46, 70-71, 74
N9355 Series	Limiters	72
N9356 Series	Limiters	72

N9410S	5500 Atomic force microscope	313
N9420A	5100 Atomic force microscope	312
N9436S	6000ILM atomic force microscope	314
N9480S	5600LS atomic force microscope	313
N9498S	5420 atomic force microscope	312
N9912A	FieldFox RF network analyzer	99
N9912A-104	4 GHz cable and antenna analyzer	99
N9912A-106	6 GHz cable and antenna analyzer	99
N9912A-230	4 GHz spectrum analyzer	99
N9912A-231	6 GHz spectrum analyzer	99
N9923A	Fieldfox RF vector network analyzer	100

P

P9400A	Solid state PIN diode switch, 100 MHz to 8 GHz	329
P9400C	Solid state PIN diode switch, 100 MHz to 18 GHz	329
P9402A	PIN solid state switch, 100 MHz to 8 GHz, SPDT	329
P9402C	PIN solid state switch, 100 MHz to 18 GHz, SPDT	329
P9404A	PIN solid state switch, 100 MHz to 8 GHz, SP4T	329
P9404C	PIN solid state switch, 100 MHz to 18 GHz, SP4T	329

S

S02MS-AG	WR-02 source module	184
S03MS-AG	WR-03 source module	184
S05MS-AG	WR-05 source module	184
S06MS-AG	WR-06 source module	184
S08MS-AG	WR-08 source module	184
S10MS-AG	WR-10 source module	184
S12MS-AG	WR-12 source module	184
S15MS-AG	WR-15 source module	184
SxxMS-AG	OML Inc millimeter-wave modules	184

T

TS-5020	Automotive functional test systems	293
TS-5030	Automotive functional test system	293

U

U1211A	Handheld digital clamp meter	136
U1212A	Handheld digital clamp meter	136
U1213A	Handheld digital clamp meter	136
U1241B	Handheld digital multimeter	135
U1242B	Handheld digital multimeter	135
U1251B	Handheld digital multimeter	135
U1252B	Handheld digital multimeter	135
U1253B	Handheld digital multimeter	135
U1271A	Handheld digital multimeter	10, 135
U1272A	Handheld digital multimeter	10, 135
U1401B	Handheld multi-function calibrator/meter	128, 136
U1602B	20 MHz handheld digital oscilloscope	15

U1604B	40 MHz handheld digital oscilloscope	15
U1701B	Handheld capacitance meter	158
U1731B	Handheld LCR meter	158
U1732B	Handheld LCR meter	158
U1818A	100 kHz to 7 GHz active differential probe	72, 159, 323
U1818A/B	differential probes, 100 kHz to 7 or 14 GHz	72, 159, 323
U1818B	100 kHz to 12 GHz active differential probe	323
U1905A	GS-8800 (PXT) wireless communication design verification benchtop system	290
U2000 Series	USB power sensors	69-70, 139-140
U2100A Series	USB digital I/O devices	264-266
U2121A	USB Digital I/O module and options for RF switching	265-266
U2122A	32-input digital input module	265
U2123A	32-output digital output module	265
U2300A Series	USB modular multifunction DAQ devices	264-265
U2331A	64-channel, 1 MSa/s, USB modular multifunction data acquisition	265
U2351A	16-channel, 250 kSa/s, USB modular multifunction data acquisition	265
U2352A	16-channel, 250 kSa/s, no analog output, USB modular multifunction data acquisition	265
U2353A	16-channel, 500 kSa/s, USB modular multifunction data acquisition	265
U2354A	16-channel, 500 kSa/s, no analog output, USB modular multifunction data acquisition	265
U2355A	64-channel, 250 kSa/s, USB modular multifunction data acquisition	265-266
U2356A	64-channel, 500 kSa/s, USB modular multifunction data acquisition	265-266
U2500A Series	USB modular simultaneous-sampling multifunction	264-265
U2531A	2 MSa/s USB modular simultaneous-sampling multifunction DAQ	265
U2541A	250 kSa/s USB modular simultaneous-sampling multifunction DAQ	265
U2542A	500 kSa/s USB modular simultaneous-sampling multifunction DAQ	265
U2600A Series	USB modular isolated digital I/O devices	264-265
U2651A	32-input, 32-output digital I/O module	265
U2652A	64-input digital input module	265
U2653A	64-output digital output module	265
U2701A	100 MHz USB modular oscilloscope	14, 16
U2702A	200 MHz USB modular oscilloscope	14, 16
U2741A	USB modular digital multimeter	127-128, 136
U2751A	USB modular switch matrix	266
U2781A	6-slot USB modular product chassis	16, 209, 240-241, 264-266

U2802A	31-channel thermocouple input module	264, 266
U3401A	Dual display digital multimeter, 4.5-digit	128-129
U3402A	Dual display digital multimeter, 5.5-digit	128-129
U3606A	Multimeter/DC power supply	127-128, 134, 222
U4002A	Digital test console two-slot chassis	109-110
U4301A	PCIe analyzer	109-110
U4305A	PCIe exerciser & PCIe LTSSM tester for PCIe 8 Gb/s	109-110
U4321A	PCIe slot interposer probe for PCIe 8 Gb/s	109-110
U4322A	PCIe mid-bus probe for PCIe 8 Gb/s	109-110
U8001A	90 W single output power supply	222, 236-237
U8002A	150 W single output power supply	222, 236-237
U8903A	Audio analyzer	48, 73-74
U9063A	Analog demodulation measurement application	285
U9071A	GSM/EDGE/EDGE evolution measurement application	285
U9072A	cdma2000 measurement application	285
U9073A	W-CDMA/HSDPA/HSUPA/HSPA+ measurement application	285
U9076A	1xEV-DO measurement application	285
U9080A	LTE measurement application	285
U9081A	Bluetooth EDR and ULP measurement application	285
U9397A	FET solid state switch, 300 kHz to 8 GHz, SPDT	329
U9397C	FET solid state switch, 300 kHz to 18 GHz, SPDT	329
U9400A	Solid state FET transfer switch, 300 kHz to 8 GHz	329
U9400C	Solid state FET transfer switch, 300 kHz to 18 GHz	329
U9401B	Medalist i1000D in-circuit test system	292
U9815A	T150 universal testing machine	317
U9820A	Nano Indenter G200	316
U9830A	Nano Indenter G300	316

V

V3500A	Handheld RF power meter	140
---------------	-------------------------	-----

W

W1320BP	Genesys Core	247
W1321BP	Genesys Core, Filter, Match	247
W1322BP	Genesys Core, Synthesis	247
W1323	Genesys core + spectrasys	249
W1323BP	Genesys Core, System	247
W1324BP	Genesys Core, Synthesis, Circuit	247
W1325BP	Genesys Core, Synthesis, EM	247
W1326BP	Genesys Core, Synthesis, Circuit, System	247

W1327BP	Genesys Core, Synthesis, Circuit, EM	247
W1328BP	Genesys Core, Synthesis, Circuit, System, EM	247
W1461	SystemVue communications architect	249
W1462	SystemVue FPGA architect	249
W1464	SystemVue RF system architect	249
W1465	SystemVue system architect	249
W1714	AMI modeling kit	249
W1715	MIMO channel builder	249
W1716	Digital pre-distortion builder	249
W1717	Hardware design kit	249
W1718	C++ code generator	249
W1719	RF system design kit (spectrasys)	249
W1903	Fixed-point library	249
W1904	Adaptive equalization library	249
W1910	LTE baseband verification	249
W1911	WiMAX baseband verification	249
W1914	DVB-2 baseband verification	249
W1915	mmWave WPAN baseband verification	249
W2342	FEM Simulator Element	246
W2361	Ptolemy element	249
W2362EP	Genesys for ADS RF Architecture and Synthesis	247
W2366	Integrated wireless libraries	249
W2368	3GPP-LTE wireless library	249
W2401	EMPro Core Environment	246
W2402	EMPro + FEM Bundle	246
W2403	EMPro + FDTD Bundle	246
W2404	EMPro + FEM + FDTD Bundle	246
W2405	FDTD Simulator Element	246
W263x Series	DDR2 BGA probes	106
W363x Series	DDR3 BGA probes	106
W4000B-EXP	Agilent VEE Express 9.2 Software	250
W4000B-PRO	Agilent VEE Pro 9.2 Software	250

Trademark Information

APC-7 is a U.S. registered trademark of Amphenol Corporation.

ARM is a registered trademark of ARM Limited.

AXIe logo is a trademark of the AXIe Consortium, Inc. for which the US registration application is pending.

Bluetooth and the **Bluetooth logos** are trademarks owned by Bluetooth SIG, Inc., U.S.A. and licensed to Agilent Technologies, Inc.

cdma2000 is a registered certification mark of the Telecommunications Industry Association. Used under license.

Intel and **Celeron** are trademarks of Intel Corporation in the U.S. and other countries.

IVI is a registered U.S. trademark of the IVI Foundation, Inc.

LTE and **LTE-Advanced Logo** are trademarks of ETSI.

LXI is a registered U.S. trademark of the LXI Consortium, Inc.

Java is a U.S. trademark of Sun Microsystems, Inc.

MATLAB is a U.S. registered trademark of The Math Works, Inc.

Microsoft is either a registered trademark or a trademark of Microsoft Corporation in the United States and/or other countries.

MIPI is a licensed trademark of MIPI, Inc. in the U.S. and other jurisdictions.

PCI-SIG, **PCIe** and **PCI EXPRESS** are registered trademarks and/or service marks of PCI-SIG.

Pentium is a trademark of Intel Corporation in the U.S. and other countries.

PXI is a registered US trademark of the PXI Systems Alliance, Inc.

Visual Studio is a registered trademark of Microsoft Corporation in the United States and/or other countries.

“WiMAX,” “Mobile WiMAX,” “WiMAX Forum,” the WiMAX Forum logo, **“WiMAX Forum Certified,”** and the WiMAX Forum Certified logo are trademarks of the WiMAX Forum.

Windows and **MS Windows** are U.S. registered trademarks of Microsoft Corporation.

Windows Vista is either a registered trademark or trademark of Microsoft Corporation in the United States and/or other countries.

Agilent reserves the right to correct printing errors.

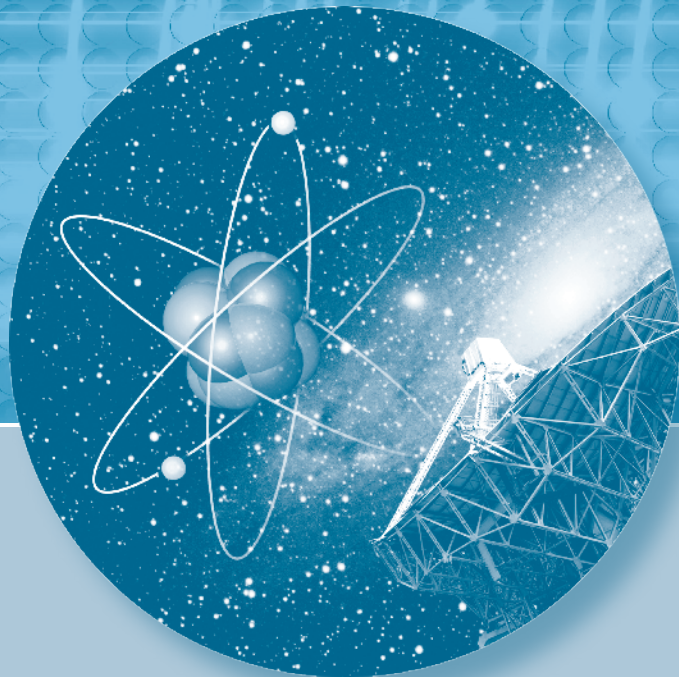



2

New Products

PXI Modular Instrumentation	2
M9392A PXI Modular Microwave Signal Analyzer	2
Handheld Spectrum Analyzers	3
X-Series Signal Analyzers	3
PSG Option UNY Enhanced Ultra-Low Phase Noise	4
89600B VSA Software	4
Signal Studio Software	5
N5247A PNA-X Microwave Network Analyzer	5
ENA Option TDR for High Speed Serial Interconnect Analysis	6
E5061B-3L5 LF-RF Network Analyzer	6
High Performance Benchtop Millimeter-Wave Network Analyzers	7
Physical Layer Test System (PLTS Version 5.5)	7
Infiniium 90000 X-Series Oscilloscopes	8
81180A 4.2 GSa/s Arbitrary Waveform Generator	8
86100D DCA-X Wide-Bandwidth Oscilloscope	9
Digital Test Console PCI Express Protocol Test System	9
N6780 Series Source Measure Units	10
U1270 Series Handheld Digital Multimeters	10
53200 Series RF and Universal Frequency Counters/Timers	11
33500 Series 30 MHz Waveform Generators	11
N7105A Signal Monitoring System	12
N6841A RF Sensor for Signal Monitoring Networks	12

PXI Modular Instrumentation

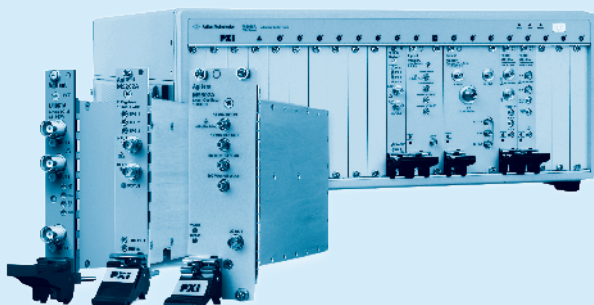

Agilent M9018A PXIe Chassis is designed for data-intensive applications in communication, imaging and radar that require wide bandwidth between modules and controller

Web Link

www.agilent.com/find/modular

- Benefit from large PXI module portfolio with world class measurement software
- Get the most performance from your PXI modular test system
- Choose your preferred software development environment

The Agilent PXI portfolio includes chassis and measurement modules – DMMs, digitizers, arbitrary waveform generators, digitizing oscilloscopes and a range of switches – integrated with software applications to get the most trusted measurements in the DC, analog, digital, microwave and lightwave domains.

With 16 hybrid slots, the M9018A PXIe chassis provides the industry's highest performance and greatest flexibility for your applications requiring wide data bandwidth.

Within this framework, work with your preferred software environment: Microsoft® Visual Studio.NET, NI LabVIEW, MATLAB®, and others. Each module is provided with instrument drivers, documentation, examples, and software tools to help you quickly develop test systems.

M9392A PXI Modular Microwave Signal Analyzer

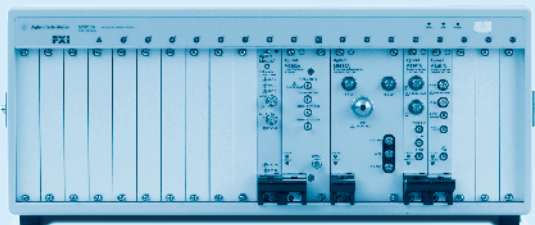

M9392A microwave vector signal analyzer shown in an M9018A 18-slot PXI Hybrid chassis

Web Link

www.agilent.com/find/M9392A

- Single-vendor PXI microwave vector signal analyzer with 250 MHz instantaneous bandwidth
- Enables detailed analysis of communications, radar and avionics signals up to 26.5 GHz
- Integrated with Agilent's powerful and widely used 89600 VSA software

With attributes that provide enough performance to satisfy even the most demanding spectrum analysis applications, the Agilent M9392A PXI vector signal analyzer system consists of the M9202A PXIe IF digitizer, M9302A PXI local oscillator, M9360A PXI attenuator/preselector, and the M9361A and M9351A PXI downconverter modules.

To quickly integrate the M9392A analyzer into your measurement environment, each module is provided with drivers and application code examples for LabVIEW, LabWindows/CVI, Visual Studio.NET (C/C++, C#, VB.NET), and MATLAB. Also included are Agilent soft front panels which help developers quickly setup and configure the instrument parameters.

The M9392A is PXI compliant, using a PXI or PXIe Hybrid slot. Designed to benefit from fast data interfaces, the products can be integrated with other test and automation modules in PXI, CompactPCI, and Hybrid chassis. The PXI format offers high performance in a small, rugged package. It is an ideal deployment platform for many automated test systems.

Handheld Spectrum Analyzers (HSA)



Field testing just got easier with Agilent HSA

Web Link

www.agilent.com/find/HSA

- N9342C HSA, 100 kHz to 7.0 GHz (NEW)
- N9340B HSA, 100 kHz to 3.0 GHz

The Agilent family of handheld spectrum analyzers (HSA), designed to excel in the field, currently offers two models: The new N9342C with frequency coverage up to 7 GHz and the N9340B with coverage up to 3 GHz. Both models measure from as low as 9 kHz, or even lower with the low frequency performance enhancement option¹.

Built-in GPS (optional²) allows measurements be taken at the correct location using GPS information (longitude, latitude, and altitude) tagged to each trace. The internal GPS antenna provides field convenience, while an SMA female-type connector is also available for an external GPS antenna.

Innovative task planner (optional²) makes RF testing easier and boosts your work efficiency to a new level. The task planner helps reduce test setup time by up to 95%, enables test automation following the pre-defined test sequence, and generates data logs and reports automatically after the test.

¹ Currently available only on N9340B
² Currently available only on N9342C

X-Series Signal Analyzers: Drive Evolution

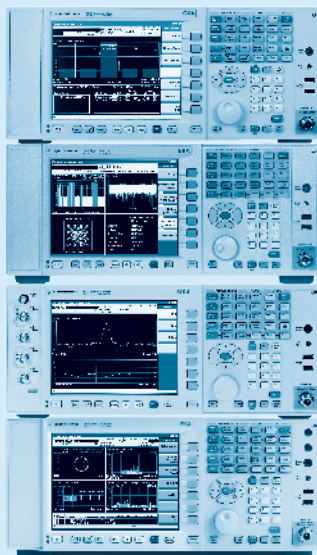

Agilent's X-Series signal analyzers drive signal analysis to the next generation

Web Link

www.agilent.com/find/x-series

- Maximize signal insights with PXA's unprecedented performance, bandwidth, and flexibility
- Accelerate technology evolution with MXA/EXA's new enhancements
- Get essential capability with X-Series expandability in the CXA – and expect more

The PXA high-performance signal analyzer maximizes signal insights with up to 75 dB spurious-free dynamic range at 140 MHz analysis bandwidth. Other industry-leading specifications include

- -129 dBc/Hz phase noise at 10 kHz offset
- ± 0.19 dB absolute amplitude accuracy
- -172 dBm DANL with Noise Floor Extension (NFE)

Enhancements to the mid-performance MXA and economy-class EXA include

- 40 MHz analysis bandwidth for analyzing complex digitally modulated signals
- Deep capture memory and flexible IF outputs
- External source control for scalar stimulus-response measurements

The CXA signal analyzer, a versatile, low-cost tool for essential signal characterization, accelerates product testing and development on multiple levels including cost reduction, throughput and design enhancement.

Over 22 advanced measurement applications transform X-Series instruments into one-button specialized analyzers. Additionally, the enhanced display package helps effectively analyze time-variant signals analysis with spectrogram display.

PSG Option UNY Enhanced Ultra-Low Phase Noise

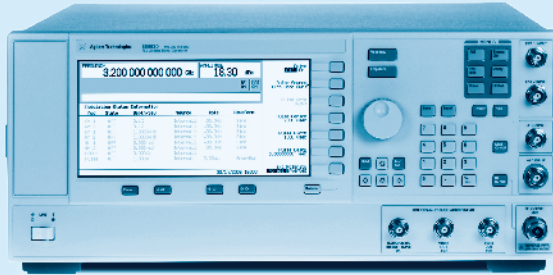

Option UNY for the PSG Series signal generators, including the E8663D shown here, provides outstanding close-in and pedestal phase noise for the most demanding applications

Web Link

www.agilent.com/find/PSG_OptionUNY

- Improved pedestal phase noise
- Improved close-in phase noise
- Reduced spurious signals

The low phase noise performance offered by Option UNY enables engineers to characterize and evaluate high-performance devices to levels not previously possible.

For a 1 GHz carrier frequency at 10 kHz offset, phase noise performance is -142 dBc/Hz specified (-146 typical), enabling greater insight for engineers developing advanced radar systems and high performance receivers.

Option UNY includes user-selectable settings for best close-in (< 150 kHz) or far-from-carrier (> 150 kHz) offsets to optimize measurements for specific applications.

Option UNY enhanced ultra-low phase noise is available on the E8257D, E8267D and E8663D PSG signal generators.

89600B VSA Software: See Through the Complexity

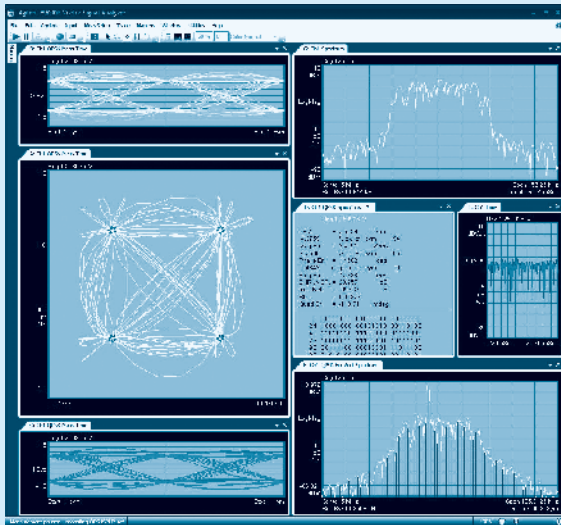

QPSK analysis with 89600B VSA

Web Link

www.agilent.com/find/89600B

- Advanced spectrum, time, and modulation analysis of over 70 signal formats
- Evaluate analog/digital baseband, RF, microwave, narrowband to UWB, SISO and MIMO
- View virtually every facet of your signal simultaneously with 20:20 trace/marker capability

On the leading edge of wireless design, signal problems are expected. Knowing there's a problem is relatively easy. Finding the cause is the challenge. Look to the Agilent 89600B vector signal analysis (VSA) software to help you meet that challenge. 89600B VSA software is your window into what's happening inside complex wireless devices.

20:20 trace/marker feature. Pinpoint problems with arbitrary arrangement – and flexible sizing – of up to 20 measurement traces at once. Isolate the sources of unexpected interactions with up to 20 markers per trace, and activate trace-to-trace coupling of markers.

Multi-domain digital persistence and cumulative history traces. Capture and analyze random or transient events in the spectrum, time, and modulation domains.

Signal Studio Software – Simplify Signal Creation



Agilent Signal Studio is a suite of flexible, easy-to-use, PC-based signal creation software that will cut the time you spend on signal simulation

Web Link

www.agilent.com/find/signalstudio

- 3GPP LTE FDD and TDD
- GPS simulator and scenario generator
- Digital video: DVB-T2, ATSC-M/H, ISDB-T/T_{SB}/T_B

With a demonstrated first-to-market track record, Agilent's Signal Studio software continues to help you stay at the forefront of product development as wireless systems, such as LTE, GPS, and digital video, continue to evolve.

Signal Studio provides an Agilent validated and performance optimized reference signal to better characterize, evaluate, and fine-tune your modern radio transceiver designs and the components that comprise them, under parametric and functional test conditions.

Our broad set of Signal Studio software is continually growing to enable the generation of a wide range of application-specific test signals, at baseband, RF, and microwave frequencies using the Agilent MXG, ESG, and PSG vector signal generators, and the PXB baseband generator and channel emulator.

N5247A PNA-X – the Premier-Performance Microwave Network Analyzer

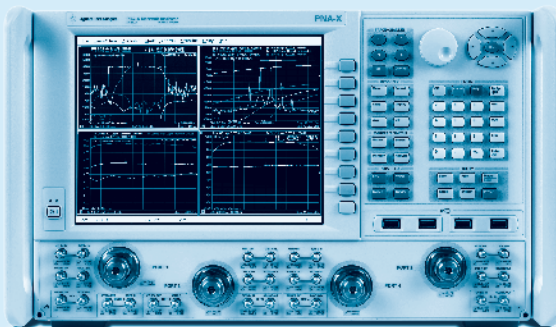

4-port PNA-X network analyzer – the ideal solution for your amplifier test needs

Web Link

www.agilent.com/find/pna-x

- 10 MHz to 67 GHz, 2 or 4-ports
- IMD, hot-S₂₂ and mixer test using the internal combiner and built-in 2nd source
- Built-in pulse generators and modulators for fast pulse measurements

The premier-performance PNA-X network analyzer offers a unique single-connection solution for two-tone and swept LO measurements, featuring an integrated second source and signal-combining network. The PNA-X also can be configured with internal pulse modulators and generators for fast and simplified pulse measurements.

The new signal routing architecture transforms it from a pure network analyzer to an RF measurement solution for amplifiers and frequency converters. With two internal signal sources – each with high output power (+13 dBm), low harmonics (–55 dBc), a wide power sweep range (40 dB), and a built-in pulse modulator and signal combiner, the PNA-X can easily perform amplifier intermodulation distortion, hot-S₂₂, traditional S-parameter and pulsed-S-parameter measurements along with harmonic and compression measurements.

One-Box Solution for High Speed Serial Interconnect Analysis

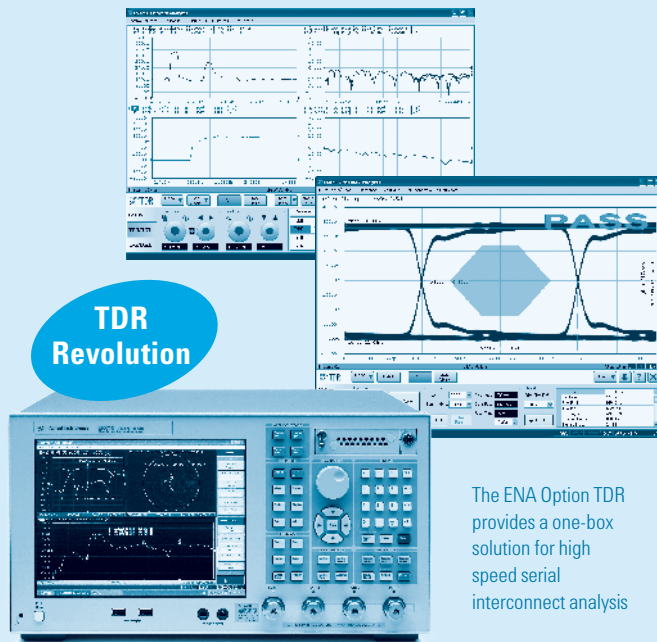

**TDR
Revolution**

The ENA Option TDR provides a one-box solution for high speed serial interconnect analysis

- Simple and intuitive operation
- Fast and accurate measurements
- ESD robustness

As bit rates of digital systems increase, signal integrity of interconnects drastically affects system performance. Fast and accurate analysis of interconnect performance in both time and frequency domains become critical to ensure reliable system performance. The E5071C ENA Option TDR provides a one-box solution for high speed serial interconnect analysis.

Inheriting the excellent accuracy from Agilent's E5071C ENA network analyzers and adding the versatility of TDR oscilloscopes, the ENA Option TDR changes the world of TDR measurements.

Web Link
www.agilent.com/find/ena-tdr

Network Analysis from 5 Hz to 3 GHz

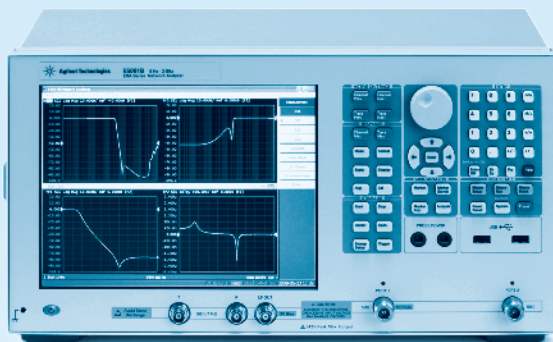

The E5061B -3L5 LF-RF network analyzer

- 5 Hz to 3 GHz frequency coverage
- S-parameter test port and Gain-phase test port
- Built-in DC bias source

The E5061B Option 3L5 LF-RF network analyzer provides versatile high-performance network analysis in a broad frequency range from 5 Hz to 3 GHz. Providing excellent RF performance that is common to the ENA Series, the E5061B also offers full-fledged LF (low frequency) network measurement capabilities; including the gain-phase test port with built-in 1 Mohm inputs.

The E5061B's comprehensive measurement applications from low to high frequencies include DC-DC converters, PDNs (power distribution networks), sensor amplifiers, and RF devices such as filters and antennas.

Web Link
www.agilent.com/find/ena-lf

High Performance Bench-Top Millimeter-Wave Network Analyzers

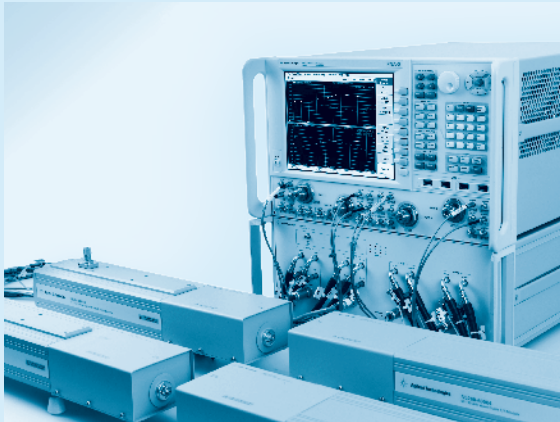

Four-port 10 MHz to 110 GHz vector network analyzer with full leveled power control

Web Link

www.agilent.com/find/na

- 110 GHz PNA-X single sweep with accurate power level control
- Includes SMC, pulse, and true differential measurements at millimeter-waves
- Lowest overall cost of ownership, only 4 system components needed

Single Sweep Solution (10 MHz – 110 GHz)

This solution includes a N5247A PNA-X based solution with N5261A/2A millimeter-wave controller, a set of Agilent millimeter-wave modules with bias tee as well as attenuator options. The system is capable of greater than 50 dB accurate power level control from 10 MHz to 110 GHz and is expandable to 1.05 THz.

PNA-X Based N5261A/2A Banded Millimeter-Wave Solution (50 GHz to 1.05 THz)

The banded millimeter-wave systems use either a 26.5, 43.5, 50 or 67 GHz PNA-X, with N5261A/62A controller and appropriate millimeter-wave frequency extenders. It covers a set of standard wave guide frequency ranges from 50 GHz to 1.05 THz with either 2 or 4 ports.

Physical Layer Test System 5.5/Test Suite Compliance Testing

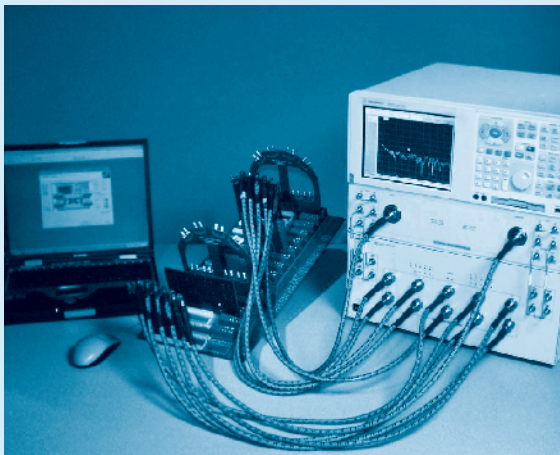

The new test suites feature of PLTS version 5.5 enables a one-step compliance and validation for various high-speed digital interconnects

Web Link

www.agilent.com/find/plts

- User defined pass/fail masks for custom compliance testing
- SATA/HDMI/USB 3.0 standard for turnkey standards verification
- Marker coupling to different traces for advanced analysis

Featuring new test suites compliance testing, PLTS 5.5 is a robust calibration, measurement and analysis platform that is ideal for signal integrity engineers doing high-speed digital design and encountering microwave transmission line effects in their printed circuit boards, connectors, cables, IC packages and backplanes.

PLTS has been a traditional research and development tool for designing the most challenging interconnect for high data rate passive devices. Multilayer backplane development has been simplified by viewing all measurement data in time, frequency, and eye diagrams in one graphical user interface. Now, this ease-of-use is available to the manufacturing engineering team for conducting compliance testing in higher volume. The transition from prototype to production is greatly simplified by using the previously defined standards specifications for today's high speed requirements. Serial ATA, HDMI and USB 3.0 are now available as turnkey compliance test suites.

90000 X-Series are the World's Fastest Oscilloscopes

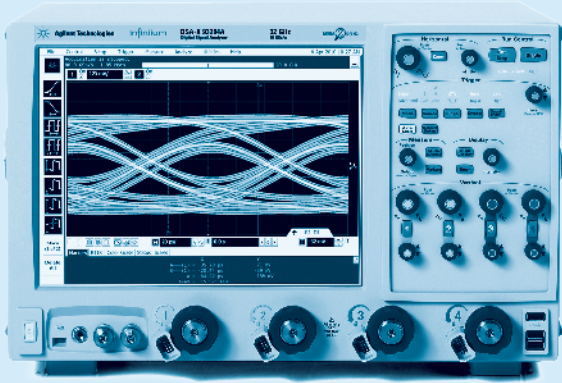

Infiniium 90000 X-Series oscilloscopes are engineered for 32 GHz true analog bandwidth that delivers

Web Link

www.agilent.com/find/90000X-Series

- Industry's highest real-time scope measurement accuracy
- Industry's only 30 GHz scope probing system
- Industry's most comprehensive application-specific measurement software

The 90000 X-Series delivers the highest measurement accuracy with its industry-leading characteristics: highest true analog bandwidth (32 GHz), lowest oscilloscope noise floor (2.00 mVrms at 50 mV/div, 32 GHz), and lowest jitter measurement floor (150 fs).

The InfiniiMax III probing solutions for the 90000 X-Series scopes feature the industry's first and only 30 GHz probe amplifier, the industry's only 30 GHz handheld probe browser, and are the first and only bandwidth-upgradeable probes.

The 90000 X-Series offers the broadest range of jitter, triggering, analysis and display tools, pre-built compliance testing software based on the expertise of our engineers on the standards committees, and support for emerging technologies including SATA 6G, SAS 12G and PCI Express® gen 3.

Complex Real-World Signals with 12-bit Vertical Resolution

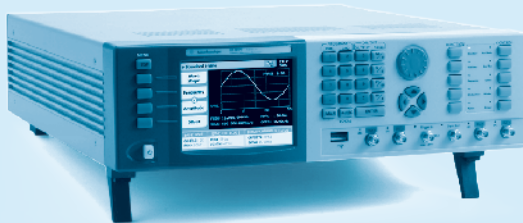

81180A 4.2 GSa/s arbitrary waveform generator

Web Link

www.agilent.com/find/81180

- 4.2 GS/s sample rate and 12 bit vertical resolution
- 2 GHz IQ modulation bandwidth for best usage with E8267D
- 1 or 2 channels, 2 instruments can form a 4 channel instrument

Create high-resolution waveforms for radar and satellite testing with Agilent's new AWG. With the 2 GHz I/Q modulation bandwidth it's a perfect complement to the Vector PSG E8267D. The 81180A drives realistic test scenarios with dynamic sequence control – in real time.

Perfect fit for WiGig, WiHD and other emerging applications with 2 GHz I/Q modulation bandwidth.

Easy integration into your environment: integrates with Signal Studio¹, MATLAB and LabVIEW software.

Advanced sequencing capability allows you to create complex arbitrary waveforms.

¹ Planned for 2011

Characterize High-Speed Digital Designs with the 86100D DCA-X Wide-Bandwidth Oscilloscope

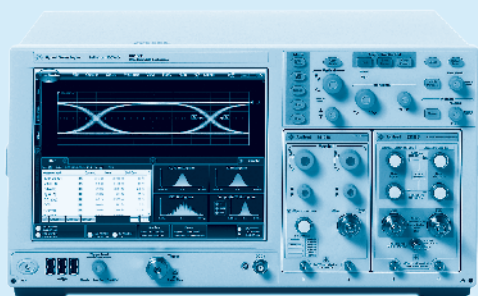

The 86100D DCA-X modular scope platform offers precision optical, electrical, PLL, TDR/TDT and S-parameter measurement capability

Web Link

www.agilent.com/find/dcac

- Industry's premier scope for measurement accuracy
- Fast, powerful analysis of ASIC, FPGA, and optical designs
- Supports 16 input channels and provides 100% backwards compatibility with all DCA modules

The new 86100D DCA-X oscilloscope combines high analog bandwidth, low noise and ultra-low jitter performance to help you accurately characterize optical and electrical designs from 50 Mb/s to over 80 Gb/s.

This new mainframe platform provides powerful new insight and measurement capabilities such as fixture and cable de-embedding, serial data channel embedding, and additional signal processing features that improve margins and allow you to see the true performance of your designs.

The new FlexDCA user interface increases productivity and usability with customizable displays, one-button setups, simultaneous display of up to 64 measurements, and a built-in pattern generator simulator with user-specified jitter and noise levels.

Digital Test Console – PCIe™ Protocol Test System for PCIe 3.0

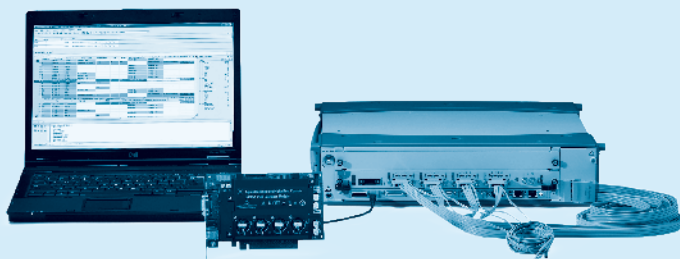

PCIe protocol test system for PCIe 3.0 with PCIe 3.0 exerciser, PCIe 3.0 analyzer and Mid-bus 3.0

Web Link

www.agilent.com/find/pcie3

- Supports 2.5 GT/s (Gen1), 5.0 GT/s (Gen2) and 8.0 GT/s (Gen3) speeds
- Link width support x1 through x16 lanes
- Mid-bus and slot interposer probing with Agilent's unique ESP technology

Agilent's digital test console PCI Express protocol test system supports all speeds of PCIe, 2.5 GT/s (Gen1), 5.0 GT/s (Gen2) through PCIe 8 GT/s (Gen3). The digital test console is the industry's most complete test solution for PCIe 3.0, with a PCIe analyzer, PCIe exerciser and both mid-bus as well as slot interposer probes.

Industry Unique ESP Technology for Accurate Data Capture

For any analyzer at PCIe 3.0 speeds, the key is how to recover the signal accurately in different types of platforms and system. Agilent's PCIe 3.0 analyzer uses Agilent's unique ESP (equalization snoop probe) technology, with the ability to tune the equalization algorithm used according to the type of channel the analyzer is monitoring. This ensures that the data captured in the analyzer is exactly what is on the wire. Without this capability, at 8 GT/s, there is a high likelihood of misrepresentation of the data on the bus, which can lead to wasted hours, if not days in the validation cycle.

Thorough Link Testing

The PCIe 3.0 exerciser with pre-defined LTSSM test cases can help validate the complex and hard to test state transitions of DUT's LTSSM. With the ability to emulate either a root complex or an end point in the same card, the PCIe 3.0 exerciser can help you validate your device whether it is a server or an add-in card. The emulated personality is easily switched through a simple software switch.

N6780 Series Source Measure Units

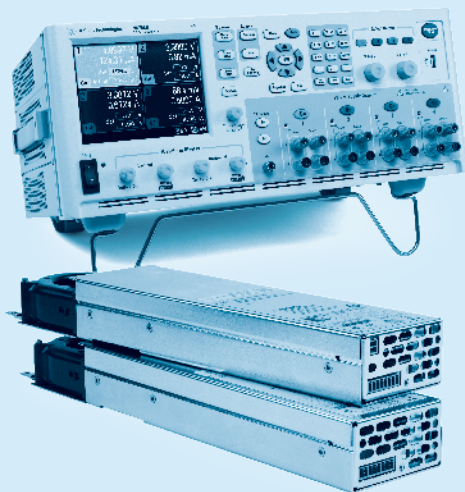

N6781A & N6782A SMUs provide seamless glitch free dynamic measurements from nano-amps to amps in one pass and one picture

- Seamless dynamic measurement ranging (N6781A & N6782A)
- 2 or 4-quadrant operation: use as a DC power supply or electronic load
- Fast modulation of DC: create waveforms up to 100 kHz

The N6780 source measure units (SMUs) are modules for the N6705B DC power analyzer and the N6700 DC modular power systems family. They provide up to 20 W of power with up to ± 20 V or up to ± 3 A.

N6781A 2-quadrant SMU for battery drain analysis offers additional features required to accurately capture the power consumption of portable battery operated devices.

N6782A 2-quadrant SMU for functional test offers features required for advanced functional test of battery-powered device components.

N6784A 4-quadrant general purpose SMU is a versatile tool for general purpose applications that require precision sourcing and measurement.

Web Link

www.agilent.com/find/N6780

Shaped to Fit, Tailored to Perform, Built to Last



The U1270 Series digital multimeters – designed for industrial handheld users

- Shaped perfectly to fit in your hand
- Intelligent features to improve productivity such low impedance mode (Z_{LOW})*, Low Pass Filter, Smart Ω^* , Qik-V** , Backlight Alert
- Water and dust resistant, robust

Water and dust resistant. Grip-friendly and feature-packed. That's what you get with an Agilent U1270 Series handheld DMM.

Certified to IP-54, these DMMs provide useful functions such as Z_{LOW} , which eliminates stray voltages, and Smart Ohm that minimizes false readings due to leakage current. To improve safety, Backlight Alert blinks the backlight to indicate continuity in noisy environments.

All of this is packed into a case that fits your hand and is easy to operate, even when you're wearing gloves.

* For U1272A only
** For U1271A only

Web Link

www.agilent.com/find/handheld-tools

53200 Series of RF and Universal Frequency Counters/Timers



53200A Series of RF/universal frequency counter/timers

Web Link

www.agilent.com/find/53200

- 350 MHz baseband frequency (optional 6 or 15 GHz channel)
- 20 picosecond single-shot time interval resolution
- Large color display: math results, histogram, trends

The Agilent 53200 RF and universal frequency counter/timer series offers base bandwidth of 350 MHz with options to extend up to 15 GHz. Measurement reading speed has increased by more than two orders of magnitude from the previous generation. The 53200 Series offers resolution performance up to 12 digits/second continuous-count gap free frequency resolution and 20 pico-second single-shot time interval resolution, giving it the highest capabilities in its class. The 53200 Series' optional battery supports remote usage and maintenance of accurate measurements by keeping the timebase warm at all times.

The large graphical display makes instrument set-up and triggering easy. LXI[®]/LAN, USB 2.0 and optional GPIB provide quick connectivity to a PC, other test instruments, or network. Storing and retrieving counter data is simple with the 1 M readings of internal memory and USB memory port.

These frequency counters offer advanced math and statistical calculations including basic modulation domain analysis (MDA), jitter analysis, and histograms. Engineers now have the capability to view measurement history and quickly see the performance of their device under test.

33500 Series 30 MHz Waveform Generators

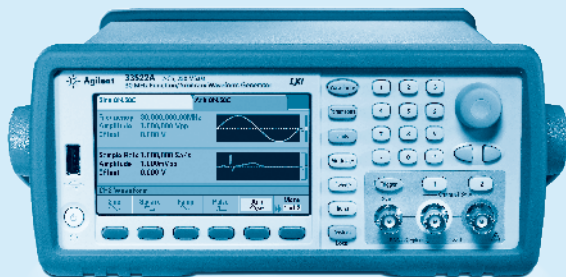

Revolutionary signal generation delivers the highest signal fidelity in its class, full-bandwidth pulses and real point-by-point arbitrary waveforms

Web Link

www.agilent.com/find/33500

- 1 & 2 Channel 30 MHz, 250 MSa/s, 16-bit
- Dual channel coupling and point by point arbitrary waveforms
- < 0.04% THD and < 40 ps jitter – any signal!

Agilent 33500 Series of function/arbitrary waveform generators offer 30 MHz sine, square, and pulse waveforms and 250 MSa/s, 16-bit sampling with true point-by-point arbitrary waveforms.

The 33500 Series provides the precision and accuracy you need, high signal fidelity with 0.04% total harmonic distortion and less than 40 ps jitter. The intuitive front-panel user interface and built-in LAN, USB and optional GPIB interfaces make it easy to setup and control, or connect to and download waveforms.

There are 1- and 2-channel models with large color displays and an embedded waveform builder. The 2-channel model has a flexible dual-channel mode with frequency and amplitude coupling, differential channels and combined output channels.

RF Signal Search and Narrowband Collection in a Modular Package



The N7100 platform meets modular open-system architecture requirements through COTS hardware

Web Link

www.agilent.com/find/N7105A

- Fast wideband search with high resolution
- Simultaneous narrowband collection on signals of interest
- Multiple RF channels, 20 MHz to 6 GHz

Through highly adaptable hardware and software capabilities, N7105A systems can be configured for a wide range of signal monitoring:

- Ultra-fast wideband search
- High-resolution signal capture
- Sustained simultaneous multiband signal collection
- Optimized signal detection tools without programming

The N7105A can address applications such as wideband recording and playback, RF survey, EMI/RFI pre-scan, spectrum analysis, range testing, and frequency management.

2

RF Sensor for Signal Monitoring Networks

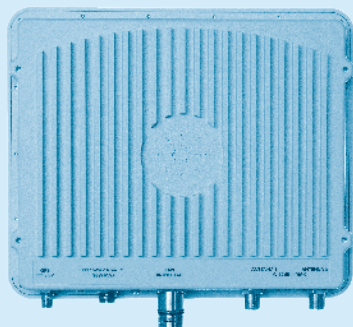

Small, discrete device in an IP67-rated weatherproof enclosure for mobile or fixed site deployments

Web Link

www.agilent.com/find/rfsensor

- Wideband RF receiver covers 20 MHz to 6 GHz
- Adjustable digital IF bandwidth to 20 MHz
- Continuous 24/7 remote RF spectrum monitoring

The Agilent N6841A RF sensor provides an extremely cost effective way to improve spectral awareness. When integrated with applications such as the Agilent N6820E signal survey monitoring software, multiple sensors can be deployed remotely and connected over any standard TCP/IP network to provide close-in signal monitoring and detection – within a building, throughout a city or across a country.

The RF sensor with its wide frequency coverage from 20 MHz to 6 GHz and digital IF bandwidth of 20 MHz not only monitors today's signals of interest, but can handle new and emerging signals. Agilent's N6841A RF sensor combines the speed of a surveillance receiver with the measurement capabilities of a vector signal analyzer.

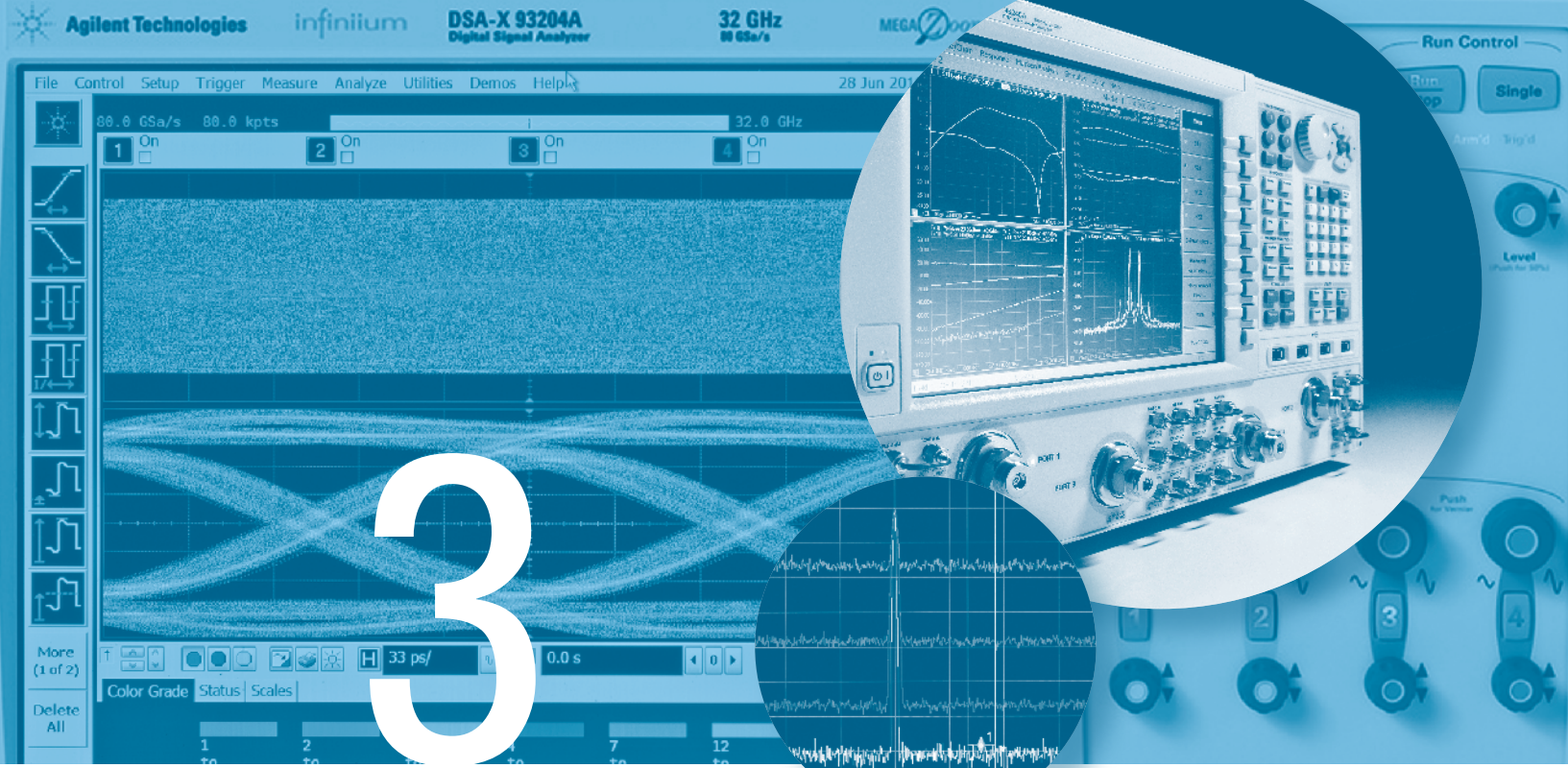

3

Oscilloscopes, Analyzers, Meters

Oscilloscopes	14
Signal Analysis	45
Network Analyzers	79
Logic Analyzers	101
Protocol Analyzers and Exercisers	108
EMI/EMC, PLTS, Signal Monitoring	116
Bit Error Ratio Test (BERT) Solutions	119
Digital Multimeters	127
Power Meters and Power Sensors	137
Frequency Counters	141
Noise Figure Analyzers and Noise Sources	145
LCR Meters & Impedance Measurement Products	149
Digitizers	160
Dynamic Signal Analyzer	166
Parameter and Device Analyzers, Curve Tracers	167
Semiconductor Production Test System	176

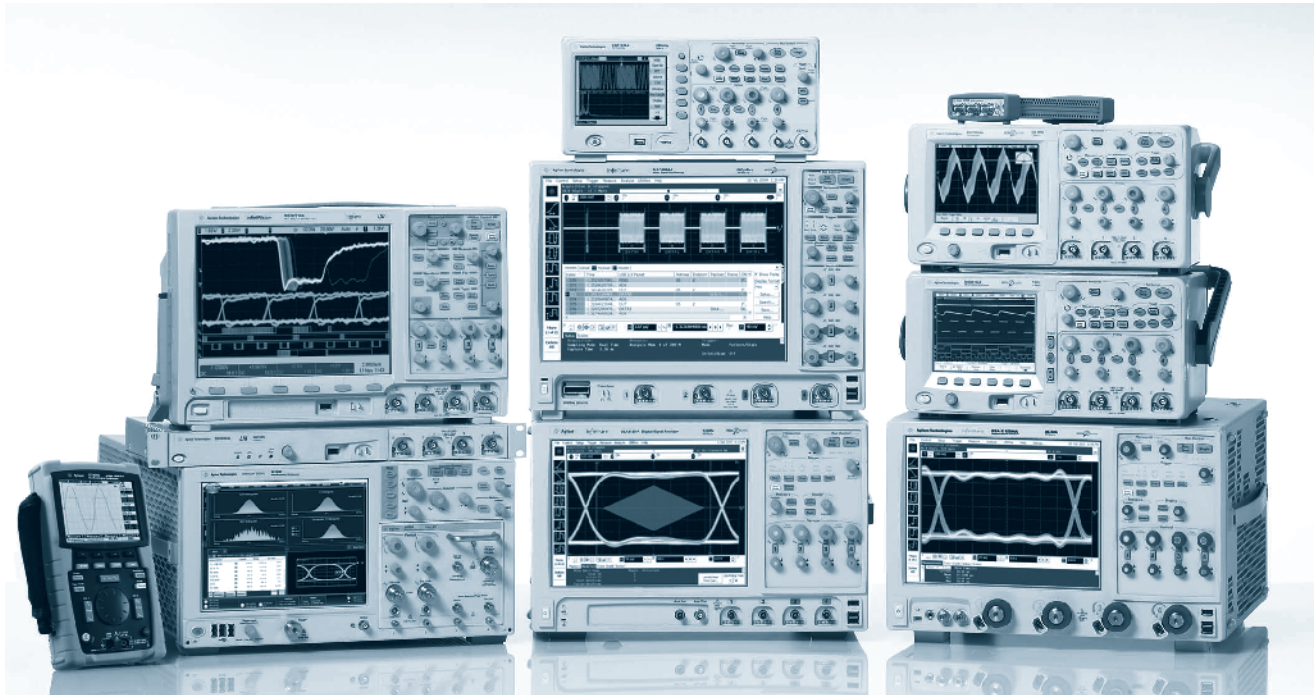

Agilent offers a comprehensive portfolio of oscilloscopes to meet all of your measurement needs

With Our Comprehensive Portfolio, You'll Find a Scope that Fits your Needs Perfectly

Whether your main consideration is price point or performance level, we offer a variety of models that will work for you. Our platforms range from USB-modular units to high-performance real-time and sampling oscilloscopes, with bandwidths from 20 MHz to more than 90 GHz. When your requirements change, so can your scope, thanks to extensive hardware and software upgrades.

Each of Our Scopes Incorporates the Innovative Technology You Expect from Agilent

As the world's largest test and measurement company, Agilent commands a breadth of engineering knowledge that enables us to deliver unique technology. Our custom MegaZoom III ASIC powers InfiniiVision's unmatched waveform update rate. The Infiniium multi-chip module supports the industry's lowest noise floor at every bandwidth. And the InfiniiMax probing system provides the flattest frequency response on the market.

Our Scopes Give You the Answers You Need, Not Just Measurements

Technology alone isn't enough – you want fast, accurate answers to your questions. That's why we offer the largest range of application-specific software available, plus an outstanding selection of probes and accessories. With flexible solutions like these, you can easily customize your instrument as your design environment changes.

Model	Bandwidth	Sample rate	Analog channels	Digital channels	Max memory depth
Handheld U1600 Series	20 – 40 MHz	200 MSa/s	2	—	125 Kpts
U2701A/U2702A USB modular	100 – 200 MHz	1 GSa/s	2	—	64 Mpts
Economy 1000 Series	60 – 200 MHz	2 GSa/s	2 or 4	—	20 kpts
Portable 5000 Series	100 – 500 MHz	2 – 4 GSa/s	2 or 4	—	8 Mpts
InfiniiVision 6000 Series	100 MHz – 1 GHz	2 – 4 GSa/s	2 or 4	16 optional	8 Mpts
InfiniiVision 7000 Series	100 MHz – 1 GHz	2 – 4 GSa/s	2 or 4	16 optional	8 Mpts
Infiniium 9000 Series	600 MHz – 4 GHz	10 – 20 GSa/s	4	16 optional	1 Gpts
Infiniium 90000 Series	2.5 – 13 GHz	20 – 40 GSa/s	4	—	1 Gpts
Infiniium 90000 X-Series	16 – 32 GHz	80 GSa/s	4	—	2 Gpts
Infiniium 86100D DCA-X wide bandwidth oscilloscope	3 – 90 GHz	40 kS (sequential)	4 (16 with new modules)	—	Configurable

Web Link

www.agilent.com/find/scope

- Three-in-one solution: dual channel oscilloscope, true RMS DMM and real-time data logger
- Large 4.5" color LCD display
- Bandwidth: up to 40 MHz with advanced triggering
- Sampling rate: up to 200 MSa/s
- Recording length: up to 125,000 points maximum
- Waveform math functions and additional FFT capability (for U1604B)
- USB 2.0 interface



U1602B handheld digital oscilloscope



U1604B handheld digital oscilloscope

A scope with a color waveform display. A DMM for basic measurements. A data logger to record DMM readings to a PC. All three capabilities are in one instrument – the U1600 Series handheld digital oscilloscopes. Designed to address the portability needs of various installation and maintenance applications, these scopes enable clear waveform viewing, easy waveform analysis and quick isolation of signal glitches.

Clearly Distinguish your Waveforms

Clearly distinguish and identify waveforms using the two channels and observe signal activity with the large LCD display – 4.5" with 320 x 240 resolution.

Effective Capture and Precise Isolation of Signals

Capture signal deviations, glitches and dropouts effectively with a real-time sampling rate of up to 200 MSa/s. You can also capture non-repeating signals at a higher sampling rate over a wider times base. With up to 125,000 points recording length, you can quickly zoom in the segment of interest and uncover even the most subtle details of the signal at a given time-base setting.

Advanced triggering types such as edge, pulse width, pattern and video signal triggering further enable quick isolation of critical events.

Quick Waveform Analysis with FFT and Dual Waveform Math Functions

Add and subtract multiple channel signals with U1600 dual waveform math function. With the U1604B's fast fourier transform (FFT) function, you can view waveforms in four windowing techniques: rectangular, hanning, hamming and Blackman-Harris.

Built-In DMM Functions

The U1600 Series offers true RMS DMM measurement functions – DC voltage, AC voltage and true RMS AC + DC voltage measurements, ohmmeter (for 2-wire resistance, capacitance, diode and continuity tests), and an auxiliary meter (for temperature, ampere measurement).

Built-In Data Logger Function

The U1600 Series comes with a standard USB 2.0 full speed interface. Together with the bundled PC link application software, you will have full remote control and data transfer capability.

Specifications

	U1602B	U1604B
3-in-1 function: scope, DMM, data-logger	Yes	Yes
Display	4.5" color display	4.5" color display
Oscilloscope channel count	2	2
Bandwidth	DC to 20 MHz	DC to 40 MHz
Maximum sampling rate	200 MSa/s single channel and interleaved 100 MSa/s per channel	200 MSa/s single channel and interleaved 100 MSa/s per channel
Maximum recording length	Up to 125,000 points, viewable on screen with zoom function	Up to 125,000 points, viewable on screen with zoom function
Cursor and zoom functions	Yes	Yes
Dual waveform math	CH1 + CH2, CH1 – CH2, CH2 – CH1	CH1 + CH2, CH1 – CH2, CH2 – CH1
FFT	No	Yes (rectangular, hamming, hanning, Blackman-Harris)
Internal scope storage	Up to 10 setups and traces	Up to 10 setups and traces
Scope measurements	Up to 22 measurements	Up to 22 measurements
Coupling	AC, DC, GND	AC, DC, GND
Range	50 ns to 50 s/div	10 ns to 50 s/div
Rise time	< 17.5 ns	< 8.8 ns
Resolution	2 ns	400 ps
Input impedance	1 MΩ < 20 pF	1 MΩ < 20 pF
Triggering	Edge, pattern, pulse width, video	Edge, pattern, pulse width, video
Trigger modes	Auto, normal, single	Auto, normal, single
Digital multimeter full scale reading	6000 count	6000 count
DC voltage, true RMS AC voltage	Max 600 V	Max 600 V
Resistance	Max 60 MΩ	Max 60 MΩ
Capacitance	Max 300 μF	Max 300 iF
Source	Digital multimeter measurements	Digital multimeter measurements
Data logger automatic measurement	Selectable: minimum, maximum, average	Selectable: minimum, maximum, average
Record size	250 points	250 points
Time span	Auto range 150 s to 20 days	Auto range 150 s to 20 days
USB host capability for external memory	Optional	Optional
Connectivity	USB 2.0 full speed	USB 2.0 full speed
Battery	7.2 V Ni-MH rechargeable battery	7.2 V Ni-MH rechargeable battery
Safety compliance	CAT III 300 V, CSA, CE	CAT III 300 V, CSA, CE

Ordering Information

U1602B 20 MHz handheld digital oscilloscope

U1604B 40 MHz handheld digital oscilloscope

Web Link

www.agilent.com/find/handheldscope

U1602B
U1604B

U2701A
U2702A

- Up to 1 GSa/s maximum sample rate
- 64 Mpts of waveform memory
- Compact and portable size – 117 mm x 180 mm x 41 mm
- Advanced triggering, including edge, pulse width and TV
- Four math functions including FFT standards
- Compatibility with Hi-speed USB 2.0 and USBTMC-USB488 standards
- Dual-play – can be used stand alone or mounted in the U2781A chassis for modular operation

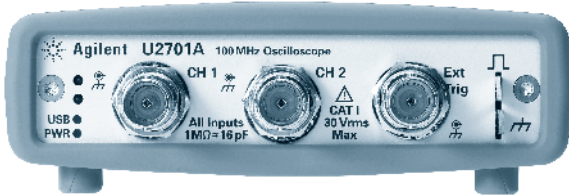

U2701A USB modular oscilloscope



U2702A USB modular oscilloscope

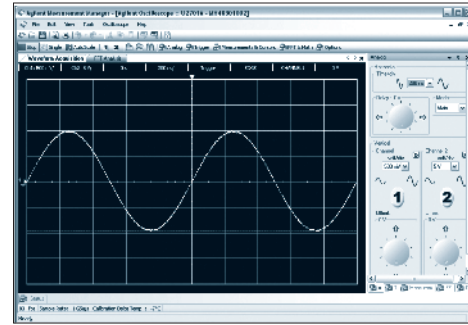

Measure waveform quickly and easily with the instrument-like AMM interface

Agilent Measurement Manager (AMM)

The AMM software is an application data viewer that enables quick configuration of instruments and measurement acquisition. It provides the familiar front panel interface of traditional bench oscilloscopes. This software is included with each modular instrument.

Specifications

	U2701A	U2702A
Bandwidth	100 MHz	200 MHz
Channel	2 + external trigger	2 + external trigger
Real time sample rate		
2 channels interleave	1 GSa/s	1 GSa/s
Each channel	500 MSa/s	500 MSa/s
Standard memory depth		
2 channels interleave	64 Mpts	64 Mpts
Each channel	16 Mpts	16 Mpts
Vertical resolution	8 bits	8 bits
Vertical range	2 mV/div to 5 V/div (1 M Ω)	2 mV/div to 5 V/div (1 M Ω)
Dynamic range	± 4 div	± 4 div
Horizontal range	1 ns/div to 50 s/div	1 ns/div to 50 s/div
Noise peak-to-peak	3 mV	3 mV
EXT trigger pulse width	> 2.5 ns	> 2.5 ns
Trigger level sensitivity	For ± 1.25 V range setting: DC to 100 MHz: 100 μ V > 100 MHz: 200 μ V	For ± 1.25 V range setting: DC to 100 MHz: 100 μ V > 100 MHz: 200 μ V
	For ± 2.5 V range setting: DC to 100 MHz: 250 μ V > 100 MHz: 500 μ V	For ± 2.5 V range setting: DC to 100 MHz: 250 μ V > 100 MHz: 500 μ V
FFT points	1250 points (for 500 ns and above)	1250 points (for 500 ns and above)
FFT noise floor	-50 to 90 dB depending on averaging	-50 to 90 dB depending on averaging

Ordering Information

U2701A 100 MHz USB modular oscilloscope
U2702A 200 MHz USB modular oscilloscope

Web Link

www.agilent.com/find/usbscope

3

These PC-hosted USB scopes are available with bandwidths of either 100 MHz (U2701A) or 200 MHz (U2702A). Both provide 500 MSa/s sampling and 16 Mpts of memory per channel (1 GSa/s and 32 Mpts with two channels interleaved) to help you gain better insight into signal details. Advanced analysis capabilities built into the Agilent Measurement Manager (AMM) scope software include waveform math and FFT with windowing. Other advanced features include:

- Normal, averaging and peak-detect acquisition modes
- Advanced triggering including edge, pulse width and line-selectable video
- Manual, auto and tracking cursors with DT, DV and frequency measurements
- Over 25 measurement and math functions
- 1,024-point FFT with hanning, hamming, Blackman-Harris, rectangular and flat top windowing functions
- Dual-screen display with FFT function and keyboard shortcut keys (with AMM software)

With the included IVI-COM and LabVIEW drivers, these scopes are compatible with popular development environments including Agilent VEE, Microsoft Visual Studio .NET, C/C++ and Visual Basic 6, the Microsoft .NET framework and LabVIEW.

Their small size makes these scopes ideal for standalone bench use as well as integration into system solutions with the U2781A chassis. Hi-speed USB 2.0 compatibility makes connection to a PC quick and easy.

- **Engineered to give you more scope than you thought you could afford**
- **More signal viewing – see more signal detail with 20 kpts memory on a display with a wider viewing angle**
- **More capabilities – 23 automatic measurements and sequence mode**
- **More productivity – get more answers in less time with advanced features**

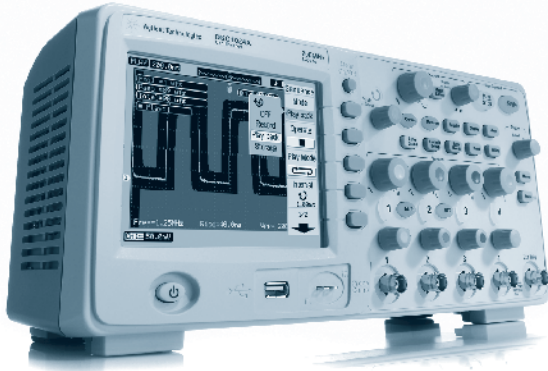

The economy 1000 Series oscilloscopes are engineered to give you more scope than you thought you could afford

More Signal Viewing

20 kpts memory per channel, up to 8 times more than competitive scopes, means you can see more time and more detail on your signal. A 5.7-inch diagonal color QVGA TFT LCD gives you a noticeably brighter and crisper waveform display. A wider viewing angle lets you see the display even when you're not right in front of the unit. True zoom mode means you can see the big picture and the details at the same time. Optionally switch off the menu display for almost 25% more viewing area.

More capabilities

23 automatic measurements give you quick access to powerful functions. Unique to its class, sequence mode allows easy debug with waveform recording, playback and storage. Selectable band pass filtering eliminates unwanted signals. Advanced triggering makes it simple to capture and view elusive signals.

Remote programming

For remote instrument control over the built-in USB interface, utilize Agilent's I/O library or National Instrument's instrument drivers for the 1000 Series scope in your application. The drivers take full advantage of industry-accepted standards and are compatible with many application development environments, such as Agilent VEE Pro, National Instrument's LabView and LabWindows/CVI.

More productivity

Go/no-go mask testing automatically detects waveforms that deviate from the standard you set. Waveform math and FFT functions give you information instantly. Graphical user interface, built-in help system, front panel overlay, and user's manuals are available in your choice of 11 languages. Autoscale puts your signals on screen with the touch of a button. Built-in USB host and device ports, plus free IntuiLink software support PC connectivity and documentation. Store setups and waveforms in internal memory or on an external USB flash drive. Standard 3 year warranty means your scope will be available when you need it.

Connectivity

Built-in USB host and device ports and free IntuiLink software make documentation and PC connectivity easy. Store waveforms and setups to a USB flash drive, easily update scope firmware and print to any PictBridge compatible printer.

Specifications

- Bandwidth (–3dB)^{1,2}:
 - DSO1002A, DSO1004A : DC to 60 MHz
 - DSO1012A, DSO1014A : DC to 100 MHz
 - DSO1022A, DSO1024A : DC to 200 MHz
- Real-time sample rate: 2 GSa/sec half channel³, 1 GSa/sec each channel
- Memory depth: 20 kpts half channel³, 10 kpts each channel
- Channels:
 - DSO1002A, DSO1012A, DSO1022A : 2 channels
 - DSO1004A, DSO1014A, DSO1024A : 4 channels
- Vertical resolution: 8 bits
- Vertical range: 2 mV/div to 10 V/div
- DC gain accuracy¹:
 - 2 to 5 mV/div: ±4.0% full scale
 - 10 mV/div to 5 V/div: ±3.0% full scale
- Vertical zoom: vertical expand
- Maximum input voltage: CAT I 300 Vrms, 400 Vpk; transient overvoltage 1.6kVpk
- Dynamic range: ±6 div
- Time-base range:
 - DSO102xA: 1 nsec/div to 50 sec/div
 - DSO101xA : 2 nsec/div to 50 sec/div
 - DSO100xA : 5 nsec/div to 50 sec/div
- Selectable bandwidth limit: 20 MHz
- Horizontal modes: main (Y-T), XY, delayed zoom and roll
- Input coupling: DC, AC and ground
- Input impedance: 1 MΩ ±1% in parallel with 18 pF ± 3 pF
- Time scale accuracy¹:
 - ±50 ppm from 0 to 30 °C,
 - ±50 ppm + 2 ppm per °C from 30 to 45 °C + 5 ppm × (years since manufacture)
- Acquisition modes:
 - Normal: displays sampled data directly to the screen in real time
 - Averaging: selectable from 2, 4, 8, 16, 32, 64, 128 or 256
 - Sequence: selectable 1 to 1,000 acquisition frames can be recorded, played back and stored in the scope memory or external USB memory
 - Peak detect: captures high-frequency glitches as narrow as 10 nsec when viewing signals at slow sweep speeds (slower than 5 μsec/div)
 - Roll: waveform display rolls from left to right. Minimum horizontal scale setting is 50 msec/div.
- Interpolation: Sinx/x
- Trigger coupling: AC, DC, LF reject
- Trigger modes:
 - Force: triggers immediately when front panel button is pressed
 - Edge: triggers on the positive or negative slope on any channel
 - Video: triggers on NTSC, PAL or SECAM video signals
 - Pulse width: triggers on pulse width greater than, equal to or less than a specific time limit, ranging from 20 nsec to 10 sec
 - Alternate: triggers on two non-synchronized active channels
- Trigger source:
 - 2-channel models: Ch 1, 2, Ext, Ext/5, AC line (edge only)
 - 4-channel models: Ch 1, 2, 3, 4, Ext, Ext/5, AC line (edge only)
- Trigger sensitivity¹:
 - ≥ 5 mV/div: 1 div from DC to 10 MHz, 1.5 div from 10 MHz to full bandwidth
 - < 5 mV/div: 1 div from DC to 10 MHz, 1.5 div from 10 to 20 MHz
- Cursor measurement: manual, track waveform or automatic measurement selections. Manual and track waveform selections provide readout of horizontal (X, ΔX, 1/ΔY) and vertical (Y, ΔY)

DSO1002A
DSO1004A
DSO1012A
DSO1014A
DSO1022A
DSO1024A

DSO1002A
DSO1004A
DSO1012A
DSO1014A
DSO1022A
DSO1024A

- Auto measurement:
 - Voltage: maximum, minimum, peak-to-peak, top, base, amplitude, average, RMS, overshoot, preshoot
 - Time: period, frequency, rise time, fall time, + width, – width, + duty cycle, – duty cycle, delay A → B (rising edge), delay A → B (falling edge), phase A → B (rising edge) and phase A → B (falling edge)
 - Counter: integrated 6-digit frequency counter on any channel. Counts up to the scope's bandwidth (200 MHz max)
- Display all measurements: mode to display all single-channel automatic measurements simultaneously on the display
- Math functions: A + B, A – B, A x B, FFT
Source channel selection for A and B can be any combination of oscilloscope channels 1 and 2 (or 3 and 4 on DSO1xx4A)
- AutoScale: finds and displays all active channels, sets edge trigger modes on highest numbered channels, sets vertical sensitivity on channels, time base to display ~2 periods. Requires minimum voltage > 20 mVpp, 1% duty cycle and minimum frequency > 50 Hz
- Display: 5.7 inch diagonal color QVGA TFT LCD display with 300 cd/m² backlight intensity:
 - Display persistence: OFF, Infinite
 - Display types: Dots, Vectors
- Waveform update rate: 400 waveforms/sec
- Save/recall internal: 10 setups and 10 waveforms can be saved and recalled using internal non-volatile memory locations. 1 reference waveform can be saved and recalled using an internal volatile memory location for visual comparisons
- Save/recall external:
 - Setups: STP saved and recalled
 - Waveforms: WFM saved and recalled, CSV saved
 - Reference waveforms: REF saved and recalled for visual comparisons
 - Images: 8-bit BMP, 24-bit BMP, PNG saved

I/O

- Standard ports: USB 2.0-compliant host ports on front and rear panel compatible with full-speed USB flash drives. USB device port for USBTMC remote PC control
- Max transfer rate: USB 2.0 full-speed up to 12 Mb/sec
- USB flash drive compatibility: most FAT formatted < 2 GB or FAT32 formatted < 32 GB flash drives
- Printer compatibility: PictBridge-compliant printers via USB device port

General characteristics

- Physical size: 12.78" W x 6.21" H x 5.08" D (32.46 cm W x 15.78 cm H x 12.92 cm D)
- Weight net: 3.03 kgs (6.68 lbs) Shipping: 4.87 kgs (10.74 lbs)

¹ Denotes warranted specifications, all others are typical. Specifications are valid after a 30-minute warm-up period and ±10 °C from firmware calibration temperature

² 20 MHz (when vertical scale is set to < 5 mV)

³ Half channel is when only one channel of channel pair 1-2 or 3-4 is turned on

Ordering Information

DSO1002A 60 MHz 2-ch DSO
DSO1004A 60 MHz 4-ch DSO
DSO1012A 100 MHz 2-ch DSO
DSO1014A 100 MHz 4-ch DSO
DSO1022A 200 MHz 2-ch DSO
DSO1024A 200 MHz 4-ch DSO

Recommended probes

N2862A 150 MHz, 10:1 passive probe (standard with 60 MHz/100 MHz models)
N2863A 300 MHz, 10:1 passive probe (standard with 200 MHz models)
10070C 20 MHz, 1:1 passive probe
10076A 250 MHz, 100:1, 4 kV passive probe
N2771A 50 MHz, 1000:1, 30 kV passive probe
N2772A 20 MHz, 1.2 kV differential probe (requires 9V battery or N2773A power adapter)
1146A 100 kHz, 100A AC/DC current probe (requires 9V battery)

Software and drivers

IntuiLink toolbar connectivity software. Downloadable free from www.agilent.com/find/intuilink

Web Link

www.agilent.com/find/1000

Engineered for the best signal visibility

- **Attractive form factor – small and compact at only 6.9” (17.5 cm) deep**
- **Fastest update rate – fastest uncompromised update rate shows you critical signal details and infrequent events that other scopes miss**
- **Smart applications – industry’s only hardware accelerated decode for serial buses and hardware based mask testing gives you faster insight**

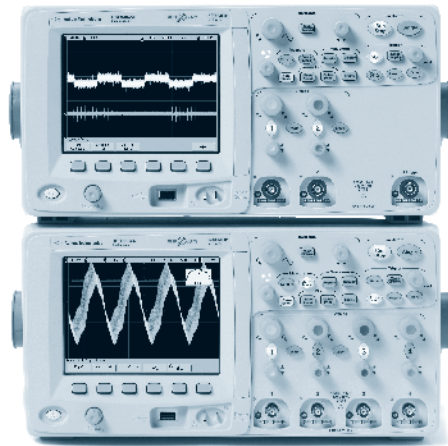

InfiniiVision 5000 Series offers 2 and 4 channel models

Attractive Form Factor

InfiniiVision oscilloscopes have a variety of form factors to meet your needs. 5000 Series portable oscilloscopes:

- Small and compact, only 6.9” (17.5 cm) deep
- 100 – 500 MHz, 2 and 4 analog channels
- 8M standard memory
- Internal storage for probes and accessories

Fastest Update Rate

Agilent’s patented MegaZoom III custom ASIC technology enables:

- Up to 100,000 waveforms per second update
- Capture more occurrences of infrequent, difficult to find events
- See subtle signal details mapped to high definition XGA display
- Fast response to user input controls
- Fast even with deep memory and application options turned on

Smart Applications

Applications for intelligent insight:

- The most complete serial applications in the market
- I²C, SPI, CAN, LIN, FlexRay, I²S, MIL-STD 1553
- Industry’s only hardware-based serial decode
- Segmented memory – smartest utilization of memory
- Pass/fail mask testing – industry’s only hardware-based

DSO5012A
DSO5014A
DSO5032A
DSO5034A
DSO5052A
DSO5054A

Specifications

	DSO5012A	DSO5014A	DSO5032A	DSO5034A	DSO5052A	DSO5054A
Bandwidth	100	100	300	300	500	500
Channels	2	4	2	4	2	4
Sample rate	2 GSa/s	2 GSa/s	2 GSa/s	2 GSa/s	4 GSa/s	4 GSa/s
Memory	8 Mpts std ¹					
Update rate	Up to 100,000 waveforms per second					
Display	6.3” color XGA LCD (1024 x 768) with 256 intensity levels					
Vertical sensitivity	2 mV/div to 5 V/div					
Maximum input voltage	CAT I 300 Vrms, 400 Vpk; transient overvoltage 1.6 kVpk ; CAT II 100 Vrms, 400 Vpk					
Input impedance	1 MΩ ± 1% 12 pF or 50 Ω ± 1.5% selectable					
Time scale accuracy	25 ppm					
Triggering	Edge, pulse width, pattern, TV (composite and HDTV/EDTV), duration, sequence, serial bus					
Peak detection	1 ns peak detect	1 ns peak detect	500 ps peak detect	500 ps peak detect	250 ps peak detect	250 ps peak detect
Measurements	Automatic Measurements are continuously updated. Cursors track last selected measurement					
Voltage	Peak-to-peak, maximum, minimum, average, amplitude, top, base, overshoot, preshoot, RMS, standard deviation, ratio (dB)					
Time	Frequency, period, + width, – width and duty cycle on any channel. Rise time, fall time, X at max Y (time at max volts), X at min Y (time at min volts), delay, and phase on oscilloscope channels only					
Counter	Built-in 5-digit frequency counter on any channel. Counts up to the oscilloscope’s bandwidth					
Threshold definition	Variable by percent and absolute value; 10%, 50%, 90% default for time measurements					
Cursors	Manually or automatically placed readout of horizontal (X, ΔX, 1/ΔX) and vertical (Y, ΔY). Tracking cursors provides an additional mode for cursor positioning beyond the current manual method. When cursor tracking is enabled, changing a cursor’s x-axis position results in the y-axis cursor tracking the corresponding y-axis (voltage, current, etc.) value. Additionally logic or scope channels can be displayed as binary or hex values					
Waveform math	f(g(t)), g(t): { 1, 2, 3, 4, 1–2, 1+2, 1x2, 3–4, 3+4, 3x4 }, f(t): { 1–2, 1+2, 1x2, 3–4, 3+4, 3x4, FFT(g(t)), differentiate d/dt g(t), integrate ∫ g(t) dt, square root √g(t) } Where 1, 2, 3, 4 represent analog input channels 1, 2, 3, and 4 (Note: channels 3 and 4 only available on DSO5xx4A models)					
Measurement statistics	Statistical data for enabled measurements such as mean, min, max, standard deviation and count					
Connectivity	2 x USB host ports, 1 x USB device port, 10/100 Mbit LAN, GPIB, and XGA out					
Warranty	3-year return-to-Agilent warranty					
Dimensions	38.5 cm wide x 18.8 cm high x 17.4 cm deep (with handle)					
Weight	4.1 kg					

¹ Maximum sample rate and memory are achieved when two channels are interleaved

DSO5012A
DSO5014A
DSO5032A
DSO5034A
DSO5052A
DSO5054A

Ordering Information

Available models

DSO5012A 100 MHz, 2-channel portable oscilloscope
DSO5014A 100 MHz, 4-channel portable oscilloscope
DSO5032A 300 MHz, 2-channel portable oscilloscope
DSO5034A 300 MHz, 4-channel portable oscilloscope
DSO5052A 500 MHz, 2-channel portable oscilloscope
DSO5054A 500 MHz, 4-channel portable oscilloscope

Standard features

- Probes: one probe per channel. DSO501x, DSO503x: N2863A
DSO505x: 10073C
- Software: Agilent IO libraries

Options

SEC secure environment mode – provides compliance with national industrial security program operating manual (NISPOM) Chapter 8 requirements

A6J ANSI Z540-compliant calibration

080 8 Mpts memory upgrade (from base 1 Mpts)

Serial data analysis applications

AMS/N5424A CAN/LIN automotive triggering and decode (4-channel models only)

LSS/N5423A I²C/SPI serial decode option (for 4-channel models only)

232/N5457A RS-232/UART triggering and decode (4 channel models only)

SND/N5468A I²S audio triggering and decode (4 channel models only)

SGM/N5454A segmented memory

LMT/N5455A mask limit testing

Available software

Oscilloscopes tools

E2690B oscilloscope tools software (U.S. and Canada)

N5385B oscilloscope tools software (international)

E2693B 1 year update subscription for oscilloscope tools (U.S. and Canada)

N5388B 1 year update subscription for oscilloscope tools (international)

N5427A secure environment mode- provides compliance with national program operating manual (NISPOM) Chapter 8 requirements industrial security

N2762A 8 Mpts acquisition memory upgrade

Accessories

N2916B rackmount kit for 6000 and 5000 Series oscilloscopes

N2917B transit case for 6000 and 5000 Series oscilloscopes

N2760A soft carrying case for 5000 Series oscilloscopes

N2790A 100 MHz, 1.4 kV high-voltage differential probe with AutoProbe interface

N2791A 25 MHz, 700 V high-voltage differential probe (battery or USB powered)

N2792A 200 MHz, ± 20 V differential probe (battery or USB powered)

N2793A 800 MHz, ± 15 V differential probe (battery or USB powered)

Web Link

www.agilent.com/find/5000a

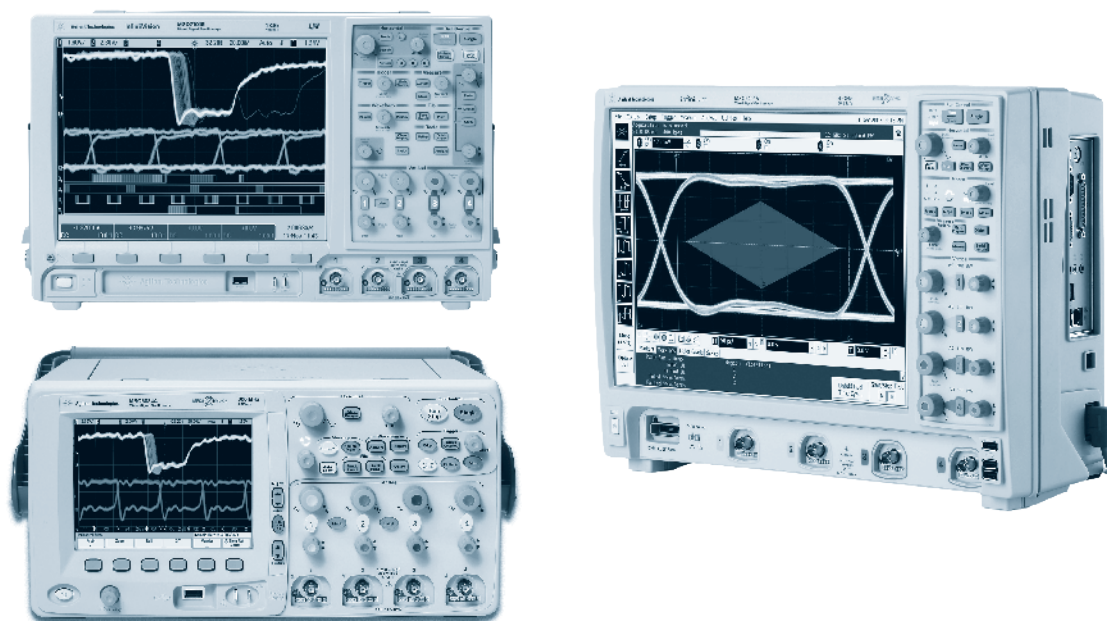

The 6000, 7000, and 9000 Series oscilloscopes offer MSO models

Analog: Up to 4 Channels with 4 GSa/s Sample Rate and 1 GHz Bandwidth

Deep Memory Provides Sustained High Sample Rates

Besides bandwidth, one of the most fundamental specifications in a digital storage oscilloscope (DSO) is its specified maximum sample rate. However, a DSO's sample rate is actually based on the scope's time base setting. At the faster time base settings, all oscilloscopes will capture waveforms using their specified maximum sample rates. But as you adjust the time base setting to slower ranges in order to capture longer waveforms, all scopes will automatically reduce their sample rates because of their limited memory depths. Deeper memory in an oscilloscope means that the scope can sustain its maximum sample rate on more time base settings, enabling you to see more details of your signals.

MegaZoom Technology

MegaZoom technology is based on a custom processor that controls the flow of data into acquisition memory and rapid post-processing for display and measurements and operates at the full speed of the scope's A/D.

MegaZoom deep memory captures long, non-repeating signals and maintains high sample rates, allowing you to quickly zoom in on areas of interest. Sample rate and memory depth go hand-in-hand. Deep memory in oscilloscopes sustains a high sample rate over longer time spans. MegaZoom also supports a high-resolution XGA display system and maps the deep memory to 256 levels of color intensity grades, delivering unmatched signal visibility.

Signal Integrity – Probing

Probing high-frequency signals becomes more challenging as the variety of test points and the frequencies of the signals continue to grow. Probes need to be lightweight, small, affordable, and offer the accessories and probe tips you require to get your job done easily. Agilent has a wide range to meet your needs.

Digital: 16 Time-Correlated Digital Channels and Mixed-Signal Triggering

In 1996 Agilent pioneered the mixed signal oscilloscope. Innovative MegaZoom IC technology delivered highly responsive deep memory so designers could see both cause and effect in digitally controlled phenomena. The first MSO was named Test & Measurement World test product of the year in 1997. While other vendors are just entering the MSO market, Agilent's third generation MegaZoom III technology continues to set the benchmark. You get uncompromised waveform update rate as you add digital, serial or deep memory capabilities to your scope.

Easily See Complex Interactions with an MSO

Mixed signal oscilloscopes (MSOs) with 2 or 4 scope channels plus 16 time-correlated logic channels combine the detailed signal analysis of a scope with the multi-channel timing measurements of a logic analyzer.

With an MSO, you are able to see multiple time-aligned analog, parallel, digital, and serially decoded waveforms on the same display. MSOs allow you to trigger on any

combination of analog and digital signals – and on many popular serial bus protocols. You can do all of this with a single, easy-to-use oscilloscope interface.

Serial: Hardware-Accelerated Decode and Trigger

Serial Bus Triggering and Decoding

Trigger on the industry's most popular serial bus standards including I²C, SPI, CAN, LIN, I²S, MIL-STD 1553, RS-232/UART, FlexRay and USB. Decode options display responsive, on-screen decode of serial bus traffic. Select from a suite of hardware triggers for the ability to isolate specific events with pin-point accuracy, then enable decode to validate serial bus activity in real-time.

Hijack Infrequent Errors

Fast acquisition speed combined with hardware-accelerated decoding increases your probability of capturing elusive events. Agilent oscilloscopes can help you catch that intermittent problem.

DSO6012A
DSO6014A
DSO6032A
DSO6034A
DSO6052A
DSO6054A
DSO6102A
DSO6104A
MSO6012A
MSO6014A
MSO6032A
MSO6034A
MSO6052A
MSO6054A
MSO6102A
MSO6104A
DSO6014L
DSO6054L
DSO6104L

Engineered for the best signal visibility

- **Attractive form factor – traditional form factor with a longer depth that is stackable and offers a battery option**
- **Fastest update rate – fastest uncompromised update rate shows you critical signal details and infrequent events that other scopes miss**
- **Smart applications – industry's only hardware accelerated decode for serial buses and hardware based mask testing gives you faster insight**

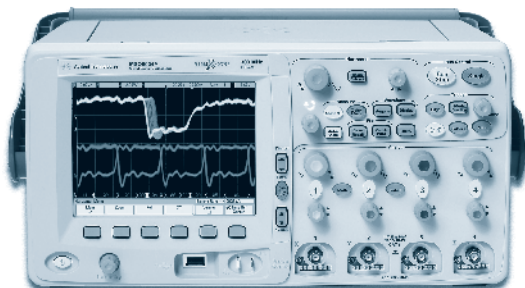

The InfiniiVision 6000 Series

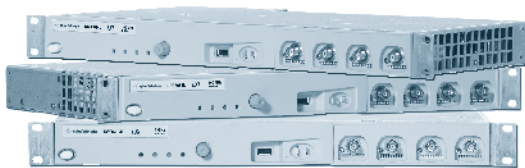

The InfiniiVision 6000L Series

3

Attractive Form Factor

InfiniiVision oscilloscopes have a variety of form factors to meet your needs

6000 Series oscilloscopes

- Traditional stackable form factor
- High-definition XGA (1024 x 768) display with 256 levels of intensity grading
- Bandwidth: 100 MHz to 1 GHz bandwidth
- Channels: 2 or 4 analog and 16 digital
- Sample rate: up to 4 GSa/s
- Battery option
- Internal storage for probes and accessories

6000L Series oscilloscopes

- 4 channels in 1U high space, faceless (no display) design
- Optimized for automated and manufacturing test environments
- Built-in web browser control
- Standard USB, LAN, GPIB interfaces and XGA out
- LXI Class C compliant
- 100% code compatible with 5000A/6000A/7000

Fastest Update Rate

Agilent's patented MegaZoom III custom ASIC technology enables:

- Up to 100,000 waveforms per second update
- Capture more occurrences of infrequent, difficult to find events
- See subtle signal details mapped to high definition XGA display
- Fast response to user input controls
- Fast even with deep memory, MSO and application options turned on

Smart Applications

Applications for intelligent insight:

- The most complete serial applications in the market – I²C, SPI, CAN, LIN, FlexRay, I²S, MIL-STD 1553, RS-232/UART, FlexRay
- Industry's only hardware-based serial decode
- Segmented memory – smartest utilization of memory
- Pass/fail mask testing – industry's only hardware-based
- Power measurement application
- Secure environment mode
- Complete connectivity including: USB, LAN, GPIB, XGA display out, LXI Class C compliant – standard

Ordering Information

Model	Bandwidth	Maximum sample rate	Memory depth	Scope channels	Digital channels
DSO6012A	100 MHz	2 GSa/s	8 Mpts	2	
MSO6012A	100 MHz	2 GSa/s	8 Mpts	2	16
DSO6014A	100 MHz	2 GSa/s	8 Mpts	4	
MSO6014A	100 MHz	2 GSa/s	8 Mpts	4	16
DSO6032A	300 MHz	2 GSa/s	8 Mpts	2	
MSO6032A	300 MHz	2 GSa/s	8 Mpts	2	16
DSO6034A	300 MHz	2 GSa/s	8 Mpts	4	
MSO6034A	300 MHz	2 GSa/s	8 Mpts	4	16
DSO6052A	500 MHz	4 GSa/s	8 Mpts	2	
MSO6052A	500 MHz	4 GSa/s	8 Mpts	2	16
DSO6054A	500 MHz	4 GSa/s	8 Mpts	4	
MSO6054A	500 MHz	4 GSa/s	8 Mpts	4	16
DSO6102A	1 GHz	4 GSa/s	8 Mpts	2	
MSO6102A	1 GHz	4 GSa/s	8 Mpts	2	16
DSO6104A	1 GHz	4 GSa/s	8 Mpts	4	
MSO6104A	1 GHz	4 GSa/s	8 Mpts	4	16
DSO6014L	100 MHz	2 GSa/s	8 Mpts	4	16 optional
DSO6054L	500 MHz	4 GSa/s	8 Mpts	4	16 optional
DSO6104L	1 GHz	4 GSa/s	8 Mpts	4	16 optional

Accessories included

- 10073C or 10074C 10:1 divider passive probe with readout per scope channel
- 16 channel flying lead set logic probe (two pods with eight channels each)
- Choose one of ABA (printed users guide in English), ABJ (printed users guide in Japanese) or AB2 (printed users guide in simplified Chinese)

Options

DSO to MSO upgrade* N2914A* for DSO/MSO601xA, DSO/MSO603xA
N2915A* for DSO/MSO605xA, DSO/MSO610xA

SEC Secure environment mode – provides compliance with national industrial security program operating manual (NISPOM) Chapter 8 requirements (factory-installed option only for new purchase)

A6J ANSI Z540 compliant calibration

Serial data analysis applications

AMS/N5424A CAN/LIN automotive triggering and decode (4 and 4 + 16 channel models only)

LSS/N5423A I²C/SPI serial decode option (for 4/4 + 16 channel models only)

232/N5457A RS-232/UART triggering and decode (4 and 4 + 16 channel models only)

SND/N5468A I²S triggering and decode (4 and 4 + 16 channel models only)

FLX/N5432C FlexRay measurements (4 and 4 + 16 channel models only)

533/N5469A MIL-STD 1553 triggering and decode (4 and 4 + 16 channel models only)

* Includes a 54620-68701 logic cable kit, a label and an upgrade license to activate the MSO features. Installs in less than 5 minutes

User installed PC-assisted applications

N5406A FPGA dynamic probe for Xilinx (MSO models only)
N5434A FPGA dynamic probe for Altera (MSO models only)
B4610A offline viewing and analysis of MSO/DSO data on a PC
U1881A power measurement and analysis application
E2690B ASA's oscilloscope tools

Other

SGM/N5454A segmented memory
BAT/N5454A re-chargeable battery option
LMT/N5455A mask limit testing

DSO6012A
 DSO6014A
 DSO6032A
 DSO6034A
 DSO6052A
 DSO6054A
 DSO6102A
 DSO6104A
 MSO6012A
 MSO6014A
 MSO6032A
 MSO6034A
 MSO6052A
 MSO6054A
 MSO6102A
 MSO6104A
 DSO6014L
 DSO6054L
 DSO6104L

Agilent InfiniiVision 6000 Series Oscilloscope Specifications

	601xA	603xA	605xA	610xA	6014L	6054L	6104L	
Channels	2 (DSO6012A)	2 (DSO6032A)	2 (DSO6052A)	2 (DSO6102A)	4 (16 logic channels available as an option)	4 (16 logic channels available as an option)	4 (16 logic channels available as an option)	
	4 (DSO6014A)	4 (DSO6034A)	4 (DSO6054A)	4 (DSO6104A)				
	2 + 16 (MSO6012A)	2 + 16 (MSO6032A)	2 + 16 (MSO6052A)	2 + 16 (MSO6102A)				
	4 + 16 (MSO6014A)	4 + 16 (MSO6034A)	4 + 16 (MSO6054A)	4 + 16 (MSO6104A)				
Scope channels	Bandwidth	100 MHz	300 MHz	500 MHz	1 GHz	100 MHz	500 MHz	
	Max sample rate	2 GSa/s	2 GSa/s	4 GSa/s	4 GSa/s	2 GSa/s	4 GSa/s	
	Max input	400 V DC + peak AC	400 V DC + peak AC	400 V DC + peak AC	400 V DC + peak AC	400 V DC + peak AC	400 V DC + peak AC	400 V DC + peak AC
	Resolution	8 bits	8 bits	8 bits	8 bits	8 bits	8 bits	8 bits
	High resolution mode	12 bits of resolution when $\geq 10 \mu\text{s}/\text{div}$ at 4 GSa/s or $\geq 20 \text{ 20 } \mu\text{s}/\text{div}$ at 2 GSa/s				< 100 nsec/div, 8 bits; 500 nsec/div, 9 bits; 2 $\mu\text{sec}/\text{div}$, 10 bits; 10 $\mu\text{sec}/\text{div}$, 11 bits; $\geq 50 \mu\text{sec}/\text{div}$, 12 bits		
	Vertical range	1 mV/div to 5 V/div (1 M Ω input)	2 mV/div to 5 V/div (1 M Ω or 50 Ω input)	2 mV/div to 5 V/div (1 M Ω or 50 Ω input)	2 mV/div to 5 V/div (1 M Ω input), 2 mV/div to 1 V/div (50 Ω input)	—	—	—
Standard memory	8 Mpts	8 Mpts	8 Mpts	8 Mpts	8 Mpts	8 Mpts	8 Mpts	
Time scale accuracy	5 nsec/div to 50/div	2 nsec/div to 50/div	1 nsec/div to 50/div	500 psec/div to 50/div	5 nsec/div to 50/div	1 nsec/div to 50/div	500 psec/div to 50/div	
Peak detection	1 ns peak detect	500 ps peak detect	250 ps peak detect	250 ps peak detect	1 ns peak detect	250 ps peak detect	250 ps peak detect	
Triggering	Source	Internal selection of CH1, CH2, (CH3, CH4) line and ext			DSO6xx4L: CH 1, 2, 3, 4, line, ext and D0-D15 for MSO-enabled DSO			
	Modes	Edge, pattern, pulse width, TV, sequence, duration Nth edge and serial protocols of I ² C, SPI, USB, CAN, LIN (advanced CAN, LIN and FlexRay available through add-on optional applications)						
Display	Type	High definition color LCD						
	Resolution	XGA – 1024 horizontal x 768 vertical, 256 levels of intensity scale						
Measurements	Automatic	Peak-to-peak, maximum, minimum, average, amplitude, top, base, overshoot, undershoot, RMS standard duration (AC RMS), frequency, period, +width, –width, duty cycle, time at max, time at min, phase, and delay						
	Counter	Built-in 5 digit frequency counter on any channel, counts up to the scope's bandwidth. The counter resolution can be increased to 8 digits with an external 10 MHz reference						
	Cursors	Manually or automatically placed readout of horizontal (X, deltaX, 1/deltaX) and vertical (Y, deltaY)						
Math functions	CH1 – CH2, 1*2, FFT, differentiate, integrate, sqrt	CH1 – CH2, 1*2, FFT, differentiate, integrate, sqrt	CH1 – CH2, 1*2, FFT, differentiate, integrate, sqrt	CH1 – CH2, 1*2, FFT, differentiate, integrate, sqrt	CH1 – CH2, CH1 + CH2, 1*2, FFT, differentiate, integrate	CH1 – CH2, CH1 + CH2, 1*2, FFT, differentiate, integrate	CH1 – CH2, CH1 + CH2, 1*2, FFT, differentiate, integrate	
Storage	Type	USB 1.1 ports on front and rear panels						
	Format	Waveform images as BMP or PNG and waveform data as CSV, ASCII XY pair or binary						
Connectivity	USB 2.0 device, 2x USB 1.1 host, 10/100 Base T LAN, GPIB and video output							
Built-in help	Key specific help in 6 languages							
Warranty	3 year	3 year	3 year	3 year	3 year	3 year	3 year	
Size	35.4 cm W x 18.8 cm H x 28.2 cm D (without handle)				43.5 cm W x 27 cm D x 4.2 cm H (without brackets)			
Net weight	4.9 kg (10.8 lbs)	4.9 kg (10.8 lbs)	4.9 kg (10.8 lbs)	4.9 kg (10.8 lbs)	2.45 kg (5.4 lbs)	2.45 kg (5.4 lbs)	2.45 kg (5.4 lbs)	

Web Link

www.agilent.com/find/6000
www.agilent.com/find/6000L

DSO7012B
DSO7014B
DSO7032B
DSO7034B
DSO7052B
DSO7054B
MSO7012B
MSO7014B
MSO7032B
MSO7034B
MSO7052B
MSO7054B
MSO7104B

Engineered for the best signal visibility

- **Attractive form factor** – industry’s largest display (12”) and only 6” (15.2 cm) deep
- **Fastest update rate** – fastest uncompromised update rate shows you critical signal details and infrequent events that other scopes miss
- **Smart applications** – industry’s only hardware accelerated decode for serial buses and hardware based mask testing gives you faster insight



InfiniiVision 7000B Series oscilloscopes are engineered for the best signal visibility

Attractive Form Factor

InfiniiVision oscilloscopes have a variety of form factors to meet your needs.

7000B Series oscilloscopes:

- Industry’s largest display (12”) with XGA high resolution and 256 levels of intensity
- Search and navigate capability
- Dedicated menu buttons to streamline daily tasks
- All knobs are pushable for quick access to common features and modes

Fastest Update Rate

Agilent’s patented MegaZoom III custom ASIC technology enables:

- Up to 100,000 waveforms per second update
- Capture more occurrences of infrequent, difficult to find events
- See subtle signal details mapped to high definition XGA display
- Fast response to user input controls
- Fast even with deep memory, MSO and application options turned on

Smart Applications

Applications for intelligent insight:

- The most complete serial applications in the market – I²C, SPI, CAN, LIN, FlexRay, I²S, MIL-STD 1553
- Serial lister – event table of packets
- Serial search and navigate – superior usability design
- Industry’s only hardware-based serial decode
- Segmented memory – smartest utilization of memory
- Pass/fail mask testing – industry’s only hardware-based
- FPGA dynamic probe – view internal FPGA activity correlated to external analog events
- Power measurement application

Ordering Information

Oscilloscope models

Model	Bandwidth	Sample rate	Memory depth	Scope channels
DSO/MSO 7012B	100 MHz	2 GSa/s	8 Mpts	2
DSO/MSO 7014B	100 MHz	2 GSa/s	8 Mpts	4
DSO/MSO 7032B	350 MHz	2 GSa/s	8 Mpts	2
DSO/MSO 7034B	350 MHz	2 GSa/s	8 Mpts	4
DSO/MSO 7052B	500 MHz	4 GSa/s	8 Mpts	2
DSO/MSO 7054B	500 MHz	4 GSa/s	8 Mpts	4
DSO/MSO 7104B	1 GHz	4 GSa/s	8 Mpts	4

Standard probe:

- 100 MHz: 10074C (default), N2871A (optional – for added price)
- 350 MHz – 1 GHz: 10073C (default), N2873A (optional – for added price)
- 16 channel flying lead set logic probe (two pods with eight channels each)
- 54695-62301 probe accessory pouch
- Built-in help language support for English, French, German, Russian, simplified Chinese, traditional Chinese, Korean, Spanish, Portuguese, Japanese and Italian
- Interface language support – GUI menus: English, simplified Chinese, traditional Chinese, Korean, Japanese
- Key/knob overlay: English, simplified Chinese, traditional Chinese, Japanese
- Printed user’s guide (Option ABA for English, Option AB2 for simplified Chinese, Option ABJ for Japanese)
- Documentation CD (PDFs of programmer’s reference guide, user guide, and service guide)
- Agilent I/O libraries suite 15.0
- Localized power cord
- Front panel cover

Note: IntuiLink data capture software available free on Web at www.agilent.com/find/intuilink

Options and accessories

- N2741A-002** 2-ch 100 MHz DSO to MSO upgrade kit*
- N2741A-004** 4-ch 100 MHz DSO to MSO upgrade kit*
- N2735A-002** 2-ch 350 MHz DSO to MSO upgrade kit*
- N2735A-004** 4-ch 350 MHz DSO to MSO upgrade kit*
- N2736A-002** 2-ch 500 MHz DSO to MSO upgrade kit*
- N2736A-004** 4-ch 500 MHz DSO to MSO upgrade kit*
- N2737A** 1 GHz DSO to MSO upgrade kit*

SEC secure environment mode – provides compliance with national industrial security program operating manual (NISPOM) Chapter 8 requirements (factory-installed option only for new purchase)

A6J ANSI Z540 compliant calibration

* Includes a 54620-68701 logic cable kit, a label and an upgrade license to activate the MSO features

Applications

AMS/N5424A CAN/LIN automotive triggering and decode (for 4 and 4+16 channel models only)

LSS/N5423A I²C/SPI serial decode option (for 4 and 4+16 channel models only)

SND/N5468A I²S triggering and decode (for 4 channel DSO/MSO models only)

232/N5457A RS-232/UART triggering and decode (for 4+16 channel models only)

FLX/N5432C FlexRay triggering and decode

533/N5469A MIL-STD 1553 triggering and decode

N5406A FPGA dynamic probe for Xilinx (MSO models only)

N5434A FPGA dynamic probe for Altera (MSO models only)

B4610A offline viewing and analysis of MSO/DSO data on a PC

U1881A power measurement and analysis application

SGM/N5454A segmented memory

LMT/N5455A mask testing-limit

Accessories

N2733A soft carrying case for 7000B Series oscilloscope

N2732A rackmount kit for 7000B Series oscilloscope

GemStar 5000 transit case with foam molding customized for InfiniiVision 7000B Series available from GemStar Mfg.

www.gemstarmfg.com

N2918A evaluation kit

N4865A GPIB-to-LAN adapter

Specifications

	701xB	703xB	705xB	7104B
Bandwidth	100 MHz	350 MHz	500 MHz	1 GHz
Channels	2 (DSO7012B) 4 (DSO7014B) 2 + 16 (MSO7012B) 4 + 16 (MSO7014B)	2 (DSO7032B) 4 (DSO7034B) 2 + 16 (MSO7032B) 4 + 16 (MSO7034B)	2 (DSO7052B) 4 (DSO7054B) 2 + 16 (MSO7052B) 4 + 16 (MSO7054B)	4 (DSO7104B) 4 + 16 (MSO7104B) 2 + 16 (MSO7052B) 4 + 16 (MSO7054B)
Sample rate	2 GSa/s	2 GSa/s	4 GSa/s	4 GSa/s
Memory	8 Mpts	8 Mpts	8 Mpts	8 Mpts
Update rate	Up to 100,000 deep-memory waveforms per second, even with deep memory, digital channels and serial decode turned on			
High resolution mode	up to 12 bits of resolution when $\geq 10 \mu\text{s}/\text{div}$ at 4 GSa/s or $\geq 20\text{-}\mu\text{s}/\text{div}$ at 2 GSa/s			
Time scale accuracy	$\leq \pm (15+2^* \text{ (instrument age in years)}) \text{ ppm}$			
Peak detection	500-ps peak detect	500-ps peak detect	250-ps peak detect	250-ps peak detect
Triggering	Sources MSO7xx2B: Ch 1, 2, line, ext, D15 – D0 DSO7xx2B: Ch 1, 2, line, ext MSO7xx4B: Ch 1, 2, 3, 4, line, ext, D15 – D0 DSO7xx4B: Ch 1, 2, 3, 4, line, ext			
	Modes Auto, normal (triggered), single			
Display	12.1-inch (255 mm x 184 mm) diagonal color TFT LCD			
Measurements	Automatic Measurements are continuously updated. Cursors track last selected measurement. Up to four measurements can be displayed on screen at any one time			
	Voltage Peak-to-peak, maximum, minimum, average, amplitude, top, base, overshoot, preshoot, RMS, standard deviation (AC RMS), ratio (dB)			
	Time Frequency, period, + width, – width and duty cycle on any channel. Rise time, fall time, X at max Y (time at max volts), X at min Y (time at min volts), delay, and phase on scope channels only			
	Counter Built-in 5-digit frequency counter on any channel. Counts up to the scope's bandwidth (1 GHz max). The counter resolution can be increased to 8 digits with an external 10-MHz reference			
	Threshold definition Variable by percent and absolute value; 10%, 50%, 90% default for time measurements			
	Cursors Manually or automatically placed readout of horizontal (X, ΔX , $1/\Delta X$) and vertical (Y, ΔY). Tracking cursors provides an additional mode for cursor positioning beyond the current manual method. When cursor tracking is enabled, changing a cursor's x-axis position results in the y-axis cursor tracking the corresponding y-axis (voltage, current, etc.) value. Additionally logic or scope channels can be displayed as binary or hex values			
	Waveform math $f(g(t)); g(t); \{ 1, 2, 3, 4, 1-2, 1+2, 1 \times 2, 3-4, 3+4, 3 \times 4 \}; f(t); \{ 1-2, 1+2, 1 \times 2, 3-4, 3+4, 3 \times 4, \text{FFT}(g(t)), \text{differentiate } d/dt g(t), \text{integrate } \int g(t) dt, \text{square root } \sqrt{g(t)} \};$ Where 1, 2, 3, 4 represent analog input channels 1, 2, 3, and 4. (Note: channels 3 and 4 only available on MSO/DSO7xx4B models)			
	Measurement statistics Statistical data for enabled measurements such as mean, min, max, standard deviation and count			
	Precision mode Automatic measurements, waveform math and FFT performed on up to 128 Kpts data record			
Storage type and format	USB 1.1 host ports on front and rear panels. Image formats: BMP (8-bit), BMP (24-bit), PNG (24-bit). Data formats: X and Y (time/voltage) values in CSV format, ASCII XY and binary format and .alb for offline viewing on a PC. Trace/setup formats: recalled			
Connectivity	USB, LAN, GPIB, XGA output	USB, LAN, GPIB, XGA output	—	—
Warranty	3 years			
Dimensions	17.9" x 11.7" x 8.6" (45.4 cm x 29.8 cm x 22 cm) with legs extended, with screen cover on			
Net weight	5.9 kg (13 lbs)			

DSO7012B
DSO7014B
DSO7032B
DSO7034B
DSO7052B
DSO7054B
DSO7104B
MSO7012B
MSO7014B
MSO7032B
MSO7034B
MSO7052B
MSO7054B
MSO7104B

Web Link

www.agilent.com/find/7000B

DSO9064A
MSO9064A
DSO9104A
MSO9104A
DSO9254A
MSO9254A
DSO9404A
MSO9404A

- Engineered for broadest measurement capability to provide the widest range of test capability
- 600 MHz to 4 GHz oscilloscopes
- Up to 20 Gsa/s
- Up to 1 Gpts memory
- MSO Option adds 16 integrated digital channels
- Protocol analysis for I²C, SPI, RS-232, CAN, LIN, FlexRay, JTAG, USB, MIPI™, PCIe, and SATA
- Numerous software applications for fast technology-specific insight

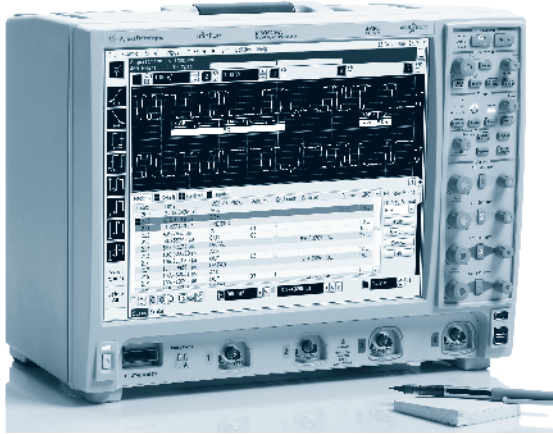

Infiniium 9000 Series oscilloscopes are engineered for the broadest measurement capability

If you're like most engineers, you never know what your next project will demand from you. You need an oscilloscope that can adapt to a wide variety of debug and test challenges. That's why we designed our Infiniium 9000 Series oscilloscope to meet a full range of needs. First we built in the powerful features you'd expect in any Infiniium scope. Then we engineered the scope for the broadest measurement capability, so it would be the most indispensable tool in your arsenal.

It's Three Instruments in One

- Scope: The powerful features of our Infiniium Series oscilloscopes coupled with superior specifications give you precise signal representation
- Logic analyzer: Fast deep-memory digital channels let you see critical data values and timing relationships
- Protocol analyzer: The world's first scope-based protocol viewer with multi-tab viewing. Quickly drill and move between protocol and physical layers

It Offers the Widest Range of Debug and Compliance Application Software

Need accurate answers to your measurement questions? The Infiniium 9000 Series offers the largest range of application-specific software for debug, analysis and compliance testing.

It's Sized to Fit your Environment

Limited bench space? It has the smallest footprint and thinnest profile
Height: 12.9" (33 cm); width: 16.8" (43 cm); depth: just 9" (23 cm).
Need to share the scope? It has the lightest weight: 26 lbs. (11.8 kg).
Need to see lots of signals? It has the biggest screen: 15" (23 cm) XGA.

3

Specifications

	DSO9064A	MSO9064A	DSO9104A	MSO9104A	DSO9254A	MSO9254A	DSO9404A	MSO9404A
Bandwidth	600 MHz	600 MHz	1 GHz	1 GHz	2.5 GHz	2.5 GHz	4 GHz	4 GHz
Sample rate	10 GSa/s, 30 GSa/s on 2 channels							
Channels	4 logic	4 + 16 logic	4 logic	4 + 16 logic	4 logic	4 + 16 logic	4 logic	4 + 16 logic
Memory	10 Mpts std. optional up to 1 Gpts							
Vertical resolution	8 bits ≥ 12 bits with averaging							
Vertical sensitivity	1 MΩ: 1 mV/div to 5 V/div, 50 Ω: 1 mV/div to 1 V/div							
Maximum input	1 MΩ: 150V RMS or DC, CAT I ± 250 V (DC + AC) in AC coupling 50 MΩ: 5 Vrms, CAT I							
Input impedance	50 MΩ ± 2.5%, 1 MΩ ± 1% (13 pF typical)							
Timebase range	5 ps/div to 20 s/div							
Timebase accuracy	± (0.4 + 0.5 * YearsSinceCal) ppm pk							
Triggering	Edge, glitch, runt, timeout, pattern/pulse range, state, pulse width, line, window, setup and hold, video, serial							
Dimensions	42.4 cm W x 31.8 cm H x 22.6 cm D							
Weight	13.9 kg							

Order the Mixed-Signal Oscilloscope (MSO) to Add 16 Digital Timing Channels to Any Scope

Oscilloscope models

Model	Bandwidth	Sample rate*	Memory depth*	Scope channels
DSO9064A	600 MHz	5 GSa/s	10 Mpts	4
MSO9064A	600 MHz	5 GSa/s	10 Mpts	4 + 16 digital
DSO9104A	1 GHz	10 GSa/s	10 Mpts	4
MSO9104A	1 GHz	10 GSa/s	10 Mpts	4 + 16 digital
DSO9254A	2.5 GHz	10 GSa/s	10 Mpts	4
MSO9254A	2.5 GHz	10 GSa/s	10 Mpts	4 + 16 digital
DSO9404A	4 GHz	10 GSa/s	10 Mpts	4
MSO9404A	4 GHz	10 GSa/s	10 Mpts	4 + 16 digital

* In 2 ch mode, sample rate and memory depth double

Options and accessories

N2900A-020 upgrade to 20 Mpts of memory
N2900A-050 upgrade to 50 Mpts of memory
N2900A-100 upgrade to 100 Mpts of memory
N2900A-200 upgrade to 200 Mpts of memory
N2900A-500 upgrade to 500 Mpts of memory
N2901D DSO9064A to MSO9064A upgrade kit
N2901A DSO9104A to MSO9104A upgrade kit
N2901B DSO9254A to MSO9254A upgrade kit
N2901C DSO9404A to MSO9404A upgrade kit
N5473A external DVD-RW with USB connection
N2902A 9000 Series oscilloscope rackmount kit
N2903A additional removable hard disk drive (requires Option 801 at time of purchase)
N4865A GPIB to LAN adapter
N2918B Infiniium evaluation kit

Recommended probes

N2783A 500-MHz passive probes (standard)
1130A 1.5 GHz InfiniiMax probe (optional)
1131A 3.5 GHz InfiniiMax probe (optional)

Applications

N5462B RS-232/UART triggering and decode
E2681A EZJIT jitter analysis software
N5384A high-speed SDA and clock recovery
N5400A EZJIT plus jitter analysis software
N5464B USB triggering and decode
N5463B PCI Express 1.1 triggering and decode
N5391B I²C/SPI triggering and decode
N8803B CAN/FlexRay triggering and decode
N5415B InfiniiScan
N5430A user-defined function
N5452A application remote programming interface
N5461A InfiniiSim signal equalization
U1882A power measurement application software
N5397A Xilinx FPGA dynamic probe
N5433A Altera FPGA dynamic probe
N5392A Ethernet compliance application
N5416A USB 2.0 compliance application
U7233A DDR1 validation application
N5413A DDR2 validation application
U7231A DDR3 validation application
N5467A user-definable application
N8802A MIPI D-PHY Trigger and decode
U7238A MIPI D-PHY compliance
N8801A SATA trigger and compliance

Post-sales upgrades

DSO → MSO upgrades
N2901D DSO9064A to MSO9064A upgrade kit
N2901A DSO9104A to MSO9104A upgrade kit
N2901B DSO9254A to MSO9254A upgrade kit
N2901C DSO9404A to MSO9404A upgrade kit

Oscilloscopes bandwidth upgrades

N2905A upgrade to 2.5 GHz bandwidth
N2905A-006 600 MHz to 2.5 GHz
N2905A-010 1 GHz to 2.5 GHz
N2904A upgrade to 4.0 GHz bandwidth
N2904A-006 600 MHz to 4 GHz
N2904A-010 1 GHz to 4 GHz
N2904A-025 2.5 GHz to 4 GHz

DSO9064A
MSO9064A
DSO9104A
MSO9104A
DSO9254A
MSO9254A
DSO9404A
MSO9404A

Web Link

www.agilent.com/find/9000

DSO91304A
 DSO91204A
 DSO90804A
 DSO90604A
 DSO90404A
 DSO90254A

- Industry's lowest noise floor at 1.27 mV at 50 mV/div
- Deepest jitter analysis capability (PRBS²³) and most accurate real-time Tj and Rj characterization for data rates up to 8.5 Gb/s and below
- Hardware accelerated de-embedding allows easy compensation for probe, fixture, and channel effects
- Over 30 software applications for compliance, debugging and analysis including: SATA 6G, PCI Express II, HDMI, Ethernet, DDR, etc.
- Customize your infiniium oscilloscope using user defined functions, user defined application, and my infiniium for more efficient operation

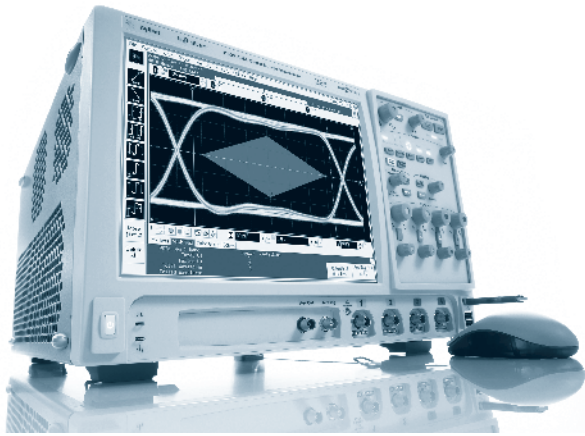

The infiniium 9000A Series oscilloscope

Engineered for Unmatched Real-time Measurement Accuracy

The Agilent infiniium 90000 Series oscilloscopes are engineered to give you unmatched real-time measurement accuracy so you can:

- Use your jitter budget in your design, not on your oscilloscope
- Pass today's demanding compliance tests more quickly
- Debug your toughest designs with confidence

The Industry's Lowest Noise Floor

Leveraging the company expertise in RF design, Agilent has invested in key technology blocks like our proprietary Faraday-caged front end to significantly reduce our inherent scope noise floor.

The Industry's Deepest Memory

With 1 Gbyte of memory, low frequency jitter components can be more quickly resolved in a single measurement. Statistical accuracy is improved with more data collection. Agilent's integrated deep memory remains responsive and allows more comprehensive testing, supporting pattern lengths up to PRBS23 for accurate transmitter and receiver results.

We Add Full Bandwidth Probing and Accurate De-embedding and Equalization Software

The performance of Agilent's oscilloscopes is matched by the superiority of our probing, de-embedding and equalization offerings. Maintain full bandwidth performance to the probe tip with our InfiniiMax probing solutions. Render waveforms anywhere in the digital serial link with our hardware-accelerated N5465A InfiniiSim waveform transformation toolset. Configurable system modeling allows you to remove the deleterious effects of unwanted channel elements, simulate waveforms with channel models inserted, view waveforms in physically unprobeable locations, and compensate for loading of probes and fixtures. The N5461A serial data equalization software allows you to model equalization techniques in real time.

Choose from a Wide Range of Complete Compliance Applications

Choose from the industry's widest range of complete applications for the Infiniium 90000 Series to ensure compliance to the leading industry standards, including SATA, PCI Express, Ethernet, USB, and more. Comprehensive set-up wizards and full automation of the required testing take the guesswork out of demonstrating compliance quickly. Get further insight with our protocol and analysis decode available on PCI Express, SATA and USB.

Specifications

	90254A	90404A	90604A	90804A	91204A	91304A
Bandwidth	2.5 GHz	4 GHz	6 GHz	8 GHz	12 GHz	13 GHz
Channels	4	4	4	4	4	4
Sample rate	20 GSa/s on 4 ch	20 GSa/s on 4 ch	20 GSa/s on 4 ch	40 GSa/s on 4 ch	40 GSa/s on 4 ch	40 GSa/s on 4 ch
Std. memory	10 Mpts on 4 ch	10 Mpts on 4 ch	10 Mpts on 4 ch	10 Mpts on 4 ch	10 Mpts on 4 ch	10 Mpts on 4 ch
Max memory	1 Gpts on 4 ch	1 Gpts on 4 ch	1 Gpts on 4 ch	1 Gpts on 4 ch	1 Gpts on 4 ch	1 Gpts on 4 ch
Rise time/ fall time	10 – 90%	140 ps	105 ps	70 ps	54 ps	35 ps
	20 – 80%	105 ps	79 ps	53 ps	38 ps	25 ps
Noise (rms at 100 mV/div)	1.27 mV	1.56 mV	1.92 mV	2.22 mV	2.80 mV	3.37 mV
Timebase range	5 ps/div to 20 s/div real-time, 5 ps/div to 500 ns/div equivalent-time					

Ordering Information

Model	Bandwidth	Channels	Sample rate	Standard memory
DSA/DSO91304A	13 GHz	4	40 GSa/s	10 Mpts/20 Mpts (DSA)
DSA/DSO91204A	12 GHz	4	40 GSa/s	10 Mpts/20 Mpts (DSA)
DSA/DSO90804A	8 GHz	4	40 GSa/s	10 Mpts/20 Mpts (DSA)
DSA/DSO90604A	6 GHz	4	20 GSa/s	10 Mpts/20 Mpts (DSA)
DSA/DSO90404A	4 GHz	4	20 GSa/s	10 Mpts/20 Mpts (DSA)
DSA/DSO90254A	2.5 GHz	4	20 GSa/s	10 Mpts/20 Mpts (DSA)

Standard accessories

- USB optical mouse
- USB keyboard
- User's quick-start guide
- Detachable accessory pouch
- Power cord
- Stylus pen
- High-performance calibration cable (not included in DSA/DSO90254A)
- E2655B probe deskew and performance verification kit
- Two 54855-67604 BNC-compatible to precision 3.5 mm (f) adapters (not included in DSA/DSO90254A)
- One-year warranty

Additional options and accessories

- DSO90000A-1CM rack mount kit
- DSO90000A-A61 ANSI Z540 compliant calibration
- DSO90000A-801 removable hard drive
- DSO90000A-803 additional PC memory – 4 GB
- DSO90000A-805 GPIB card-interface
- DSO90000A-807 1 M ohm, adapter with a 500 MHz passive probe
- DSO90000A-820 DVD-RW
- DSO90000A-821 additional precision BNC to SMA adapters, qty 2
- DSO90000A-822 external touchscreen monitor for Infiniium
- DSO90000A-823 PCI Express link

Presales memory options

- DSO90000A-01G 1 G memory/CH upgrade
- DSO90000A-500 500 M memory/CH upgrade
- DSO90000A-200 200 M memory/CH upgrade
- DSO90000A-100 100 M memory/CH upgrade
- DSO90000A-50M 50 M memory/CH upgrade
- DSO90000A-20M 20 M memory/CH upgrade

Oscilloscope bandwidth upgrades

- N5471A DSA/DSO91204A to DSA/DSO91304A upgrade (12 to 13 GHz)
- N5471B DSA/DSO90804A to DSA/DSO91204A upgrade (8 to 12 GHz)
- N5471C DSA/DSO90604A to DSA/DSO90804A upgrade (6 to 8 GHz)
- N5471D DSA/DSO90404A to DSA/DSO90604A upgrade (4 to 6 GHz)
- N5471E DSA/DSO90254A to DSA/DSO90404A upgrade (2.5 to 4 GHz)

Oscilloscope memory upgrades

- N5472A after-purchase 10 to 20 M memory upgrade
- N5472B after-purchase 20 to 50 M memory upgrade
- N5472C after-purchase 50 to 100 M memory upgrade
- N5472D after-purchase 100 to 200 M memory upgrade
- N5472E after-purchase 200 to 500 M memory upgrade
- N5472F after-purchase 500 M to 1 G memory upgrade

Web Link

www.agilent.com/find/90000A

DSO91304A
DSO91204A
DSO90804A
DSO90604A
DSO90404A
DSO90254A

DSAX93204A
DSOX93204A
DSAX92804A
DSOX92804A
DSAX92504A
DSOX92504A
DSAX92004A
DSOX92004A
DSAX91604A
DSOX91604A

- 32 GHz true analog bandwidth
- 80 GSa/s maximum sample rate
- 2 Gpts of memory
- Industry's lowest noise floor
- Industry's lowest jitter measurement floor
- Over 40 analysis, protocol, and compliance applications

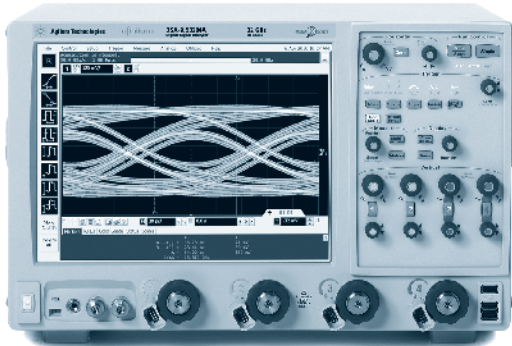

The Infiniium 90000 X-Series oscilloscope is the world's fastest real-time oscilloscope

The Infiniium 90000 X-Series is the world's fastest oscilloscope with 32 GHz of true analog bandwidth, the deepest memory depth at 2 Gpts, the fastest sampling rate at 80 GSa/s, the lowest noise floor, and the lowest jitter measurement floor. Whether you are designing high speed serial busses, directly digitizing very high frequency carrier frequencies, looking for transient measurements in high end physicists measurements, or analyzing very complex modulation schemes; the 90000 X-Series will provide the most accurate and truest representation of your actual signal.

The 90000 X-Series is the culmination of the last 10 years of oscilloscope design expertise, it features seven new chips designed in Agilent's custom Indium Phosphide technology. While other vendors are using DSP boosting and frequency interleaving to achieve high bandwidth (which tradeoff higher bandwidth with higher noise and jitter), the 90000 X-Series achieves its high bandwidth through raw hardware performance, providing superior measurement accuracy. The measurement accuracy can ultimately mean more design margins, more signal content, or greater insight into designs.

Specifications

- 32 GHz analog bandwidth (2 channels)
- 16 GHz analog bandwidth (4 channels)
- 80 GSa/s sample rate
- 2 Gpts of memory
- < 2.2 mVrms noise at 50mV/div and 32 GHz
- < 500 uV at 10mV/div
- EVM rated at 1.2%
- 150 fs jitter measurement floor
- > 5 ENOB at 30 GHz
- > 1000 wfm/s update rate
- 22 GHz edge trigger
- ± 0.2 db magnitude flatness to 32 GHz
- 30 GHz probing system

Ordering Information

Mainframe

- DSAX93204A** 32 GHz signal analyzer*
- DSOX93204A** 32 GHz digital signal oscilloscope
- DSAX92804A** 28 GHz signal analyzer*
- DSOX92804A** 28 GHz digital signal oscilloscope
- DSAX92504A** 25 GHz signal analyzer*
- DSOX92504A** 25 GHz digital oscilloscope
- DSAX92004A** 20 GHz signal analyzer*
- DSOX92004A** 20 GHz digital oscilloscope
- DSAX91604A** 16 GHz signal analyzer*
- DSOX91604A** 16 GHz digital oscilloscope

All models come with power cord, keyboard, mouse, stylus, calibration cable, wrench and coax adapter.

* DSA models come with 20 Mpts memory, EZJIT, EZJIT+, noise reduction, and serial data analysis standard

Memory

- DSOX90000A-020** 20 Mpts/ch memory
- DSOX90000A-050** 50 Mpts/ch memory
- DSOX90000A-100** 100 Mpts/ch memory
- DSOX90000A-200** 200 Mpts/ch memory
- DSOX90000A-500** 500 Mpts/ch memory
- DSOX90000A-01G** 1 Gpts/ch memory
- DSOX90000A-02G** 2 Gpts/ch memory

10 M memory standard, add option to increase to desired capacity.

Options

Model number	Options	Description
	DSOX90000-A6J	ANSI Z540 compliant calibration
N5473A	DSOX90000-820	DVD RW
82350B	DSOX90000-805	GPIO card – interface
N4866A	DSOX90000-823	PCI express card – interface
N5443A	DSOX90000-0C-PROBES	Performance verification de-skew fixture
N5470A	DSOX90000-1CM	Rack mount kit option
N5474A	DSOX90000-801	Removable hard drive

Probes and accessories

- N2803A** 30 GHz probe amp
- N2802A** 25 GHz probe amp
- N2801A** 20 GHz probe amp
- N2800A** 16 GHz probe amp
- N5439A** ZIF probe head
- N5445A** browser (hand held) probe head
- N5441A** solder-in probe head
- N5444A** 3.5 mm/2.92 mm probe head
- N5440A** 450 Ω ZIF tip replacement (set of 5)
- N5447A** 250 Ω ZIF tip replacement (set of 5)
- N5446A** browser tip replacement (set of 5)
- N5443A** PV/deskew kit
- N5442A** auto probe adapter
- N5447A** sampling scope adapter
- N5448A** flexible cable set add on 2.92 mm
- N5449A** high impedance adapter

Application Software

Measurement, analysis and decode software packages

Model number	Product number	Description
N8803A	DSOX90000-063	CAN/FlexRay decode
E2681A	DSOX90000-002	EZJIT jitter analysis software
N5400A	DSOX90000-004	EZJIT plus jitter analysis software
E2688A	DSOX90000-003	High-Speed SDA and clock recovery
N5391A	DSOX90000-007	I ² C/SPI decode
N5415A	DSOX90000-009	InfiniiScan software triggering
N5465A-001	DSOX90000-013	InfiniiSim basic signal de-embedding
N5465A-002	DSOX90000-014	InfiniiSim advanced signal de-embedding
N5461A	DSOX90000-012	Infiniium serial data equalization
	DSOX90000-061	MATLAB – standard digital analysis package
	DSOX90000-062	MATLAB – basic digital analysis package
N8802A	DSOX90000-019	MIPI D-PHY protocol
N5463A	DSOX90000-017	PCI-Express protocol
N5452A	DSOX90000-011	Remote programming interface
N5462A	DSOX90000-015	RS-232/UART decode
N8801A	DSOX90000-018	SATA/SAS protocol
N5464A	DSOX90000-016	USB protocol
N5430A	DSOX90000-010	User-defined function

Compliance testing and validation software packages

Model number	Product number	Description
U7233A	DSOX90000A-031	DDR1 validation application
N5413A	DSOX90000A-032	DDR2 validation application
U7231A	DSOX90000A-033	DDR3 validation application
U7232A	DSOX90000A-028	DisplayPort compliance application
N5399A	DSOX90000A-023	HDMI compliance application
U7238A	DSOX90000A-035	MIPI D-PHY compliance application
N5393B	DSOX90000A-022	PCI Express compliance application
	DSOX90000A-027	SAS compliance application
N5411B	DSOX90000A-038	SATA 6 Gb/s compliance
U7243A	DSOX90000A-041	USB 3.0 compliance software
N5467A	DSOX90000A-040	User defined application
U7236A	DSOX90000A-036	10GBASE-T automated test application

Web Link

www.agilent.com/find/90000X-series

DSAX93204A
DSOX93204A
DSAX92804A
DSOX92804A
DSAX92504A
DSOX92504A
DSAX92004A
DSOX92004A
DSAX91604A
DSOX91604A

86100D

- **Optical – transceiver design and manufacturing**
- **Electrical – ASIC/FPGA/IC design and characterization**
- **TDR/TDT/S-Parameter – serial bus design, cable, and PCB characterization**

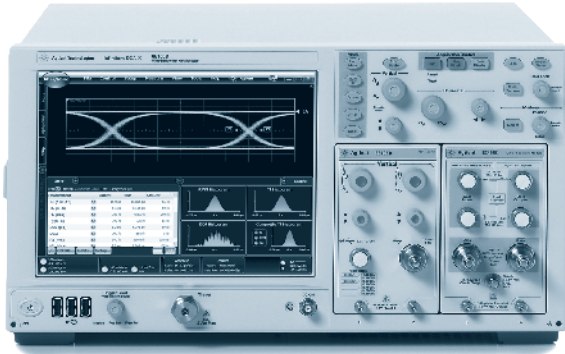

The 86100D DCA-X wide-bandwidth sampling oscilloscope

Overview of the Infiniium DCA-X

The 86100D DCA-X can be viewed as four powerful instruments in one:

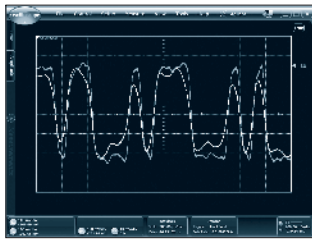

Scope mode – high-fidelity waveform characterization

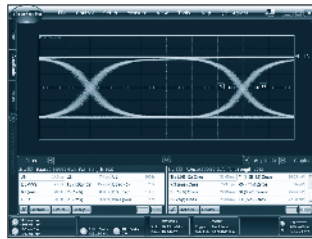

Jitter mode – precision jitter, amplitude, and frequency analysis capability

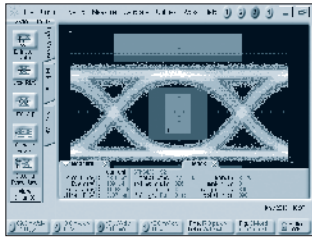

Eye/mask mode – fast transmitter characterization using eye diagram analysis

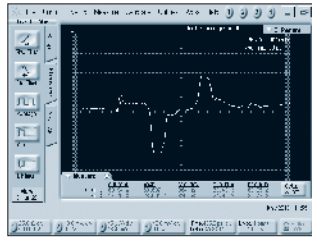

TDR/TDT mode – accurate time domain reflectometry/transmission and S-Parameter measurements

These modes are further complemented by the following features that provide additional insight and analysis capability:

- De-embedding, embedding, equalizer capability
- Phase noise/jitter spectrum analysis
- Phase locked loop (PLL) analysis
- And more...

Precision measurements, more margin, and more insight

The 86100D DCA-X oscilloscope combines high analog bandwidth, low jitter, and low noise performance to accurately characterize optical and electrical designs from 50 Mb/s to over 80 Gb/s. The mainframe provides the foundation for powerful insight and measurement capability, such as de-embedding of cables and fixtures, that improve margins and allow engineers to see the true performance of their designs.

Modular

The modular system means that the instrument can grow to meet your needs, when you need it. There's no need to purchase capability that you don't need now. The DCA-X supports a wide range of modules for testing optical and electrical designs. Select modules to get the specific bandwidth, filtering, and sensitivity you need. The DCA-X supports all modules in the DCA family and is 100% backwards compatible with the 86100C mainframe.

Software

The DCA-X provides powerful analysis capability that is enabled through licensed software options. Examples include 86100D-200 for fast and accurate jitter analysis, and 86100D-SIM for de-embedding and/or embedding of fixtures and cables.

Benefits

The DCA-X provides designers with a variety of benefits:

- Improved margins, differentiated products

Standards are continually moving towards faster and faster data rates in response to market demands. As a result, data signals have shorter bit periods and faster edge speeds. In order for digital communication systems to approach error-free performance, engineers often employ techniques such as emphasis and equalization, and they take great care to minimize jitter and noise impairments on their signals.

The 86100D DCA-X is architected to provide the optimum combination of wide-bandwidth, low noise, and low jitter so that you measure the *true* performance of your design, not the scope itself.

These attributes provide industry-leading waveform fidelity that yield:

- more accurate waveform measurements
- lower jitter measurements
- improved mask margins

With the addition of Option SIM InfiniiSim-DCA, signal degradation due to fixtures or cables can be removed, or de-embedded, providing even more margin. Alternatively, it is also possible to simulate the signal at the end of a fixture or cable (embedding).

Compliant Measurements

The DCA makes it easy to perform compliant measurements accurately and quickly.

- Over 50 built-in standards-based masks with built-in mask margin analysis
- Optical reference receivers
- Fast, accurate, and compliant jitter measurements

Lower Cost of Test

Increased channel density and fast measurement functions and algorithms (such as fast auto scale and extinction ratio tuning) result in lower cost of test.

- High density channel count decreases the cost per optical channel
- Optimized algorithms for manufacturing, significantly improves throughput – the same number of DUTs can be tested each year with fewer instruments

Faster Time to Market

Start making meaningful measurements more quickly and get your product to market faster. The DCA-X user interface has been designed so that even novice users can become proficient scope users very quickly.

- Single keystroke mode buttons quickly configure standards-based measurements
- Context sensitive follow-me help
- Customizable displays

Upgradeable, Backwards Compatible

The modular architecture of the 86100D means that the instrument can grow to meet your needs, as your needs evolve. There's no need to purchase capability that you don't need now.

- Modular – easily upgrade your system as your needs change
- Supports all 86100/83480 Series modules ever shipped
- 100% backwards compatible with the 86100C mainframe

Specifications

System configuration

The 86100D DCA-X is a modular platform. It consists of a mainframe, mainframe software, and plug-in modules.

Mainframe

The 86100D is the mainframe – it is the foundation on which this powerful platform is built.

86100D hardware options

Trigger Option

- Option STR – standard trigger
 - For basic eye diagram measurements
- Option ETR – enhanced trigger
 - For pattern waveform and more advanced measurements such as jitter analysis. Option ETR increases trigger bandwidth to > 13 GHz and adds pattern and module trigger capability
 - A Standard unit may be upgraded later by ordering 86100DU-ETR

GPIB Option

- Option GPI – GPIB card, factory installed
- Option GPN – no GPIB card interface

To add a GPIB card later, order Agilent part number 82351A or contact your local Agilent service center.

Hard Drive Option

- Option 090 – removable hard drive
- Option 092 – fixed internal hard drive (default)

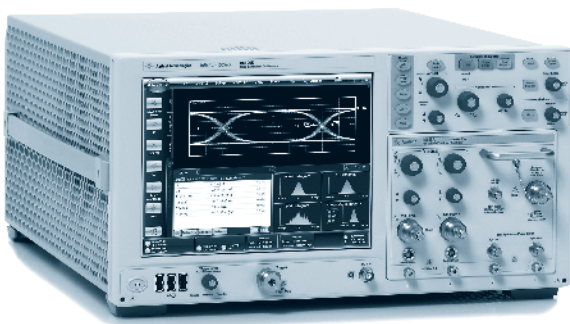

Mainframe software

- 86100D-061/062 MATLAB basic/standard package (requires Option 201): analyze and visualize oscilloscope signals, automate measurements, and design and apply your own filters using the analysis power of MATLAB software
- 86100D-200 jitter analysis software (requires Option ETR): accurately analyze jitter, including decomposition of jitter into its constituent components
- 86100D-201 advanced waveform analysis software: generates ultra-deep memory waveform files, supports real-time MATLAB analysis, and integrates a built-in linear feed-forward equalizer (LFE)
- 86100D-202 enhanced impedance and S-Parameter software: provides real-time S-Parameter measurements at the touch of *one* button
- 86100D-300 amplitude analysis/RIN/Q-factor (requires Options ETR and 200): extends jitter mode into the amplitude domain and helps you to quickly determine the root cause for eye closure
- 86100D-SIM InfiniiSim-DCA software: de-embedding, embedding and virtual probing capabilities that help characterize high-speed digital designs more thoroughly and with improved margins
- 86100DU-400 PLL and jitter spectrum software: characterize phase locked loops (PLL) using FREE 86100CU-400 software
- 86100DU-401 advanced EYE analysis software: performs compliant jitter measurements on long patterns, such as PRBS31 or live traffic, and performs BER-contour mask testing on high-speed digital designs
- N1010A FlexDCA: provides oscilloscope eye/mask, and jitter mode measurement capabilities on your PC

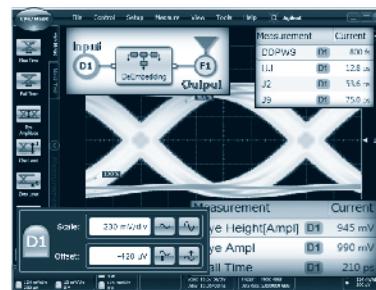

- N1010A controls an 86100C/D via a LAN connection, or it can also operate in an offline mode using saved waveforms or the built-in waveform simulator

General Purpose Passive Probes

Oscilloscope	10:1	100:1	1000:1	1:1	Low Z	Active single ended	Active differential	Current
DS01000A	N2862A, N2863A	10076B	N2771A	10070C	—	—	N2791A, N2792A, N2793A, N2891A	1146A, N2780/1/2/3A ⁷
DS05000A	N2863A, N2873A	10076B	N2771A	10070C, N2870A	N2874A, N2876A	1156A, 1144A ³ , 1145A ³ , N2795A	1130A ⁶ , 1141A ³ , N279xA, N2891A	1146A, 1147A, N2780/1/2/3A ⁷
MSO/DSO6000, MSO/DSO7000 (300 MHz – 1 GHz)	10073D	10076B	N2771A	10070C	—	1156A, 1144A ³ , 1145A ³ , N2795A, N2796A	1130 ⁶ , 1141A ³ , N2790A, N2791A, N2792A, N2793A, N2891A	1146A, 1147A, N2780/1/2/3A ⁷
MSO/DSO6000, MSO/DSO7000 (100 MHz)	10074C, N2871A	10076B	N2771A	10070C	—	N2795A (for 7000 100 MHz)	N2791A, 1141A ^{2,3} , N2792A, N2793A, N2891A	1146A, N2780/1/2/3A ⁷
Infiniium DSO/MSO9000	N2873A	10076B	N2771A	N2870A	N2874A, N2876A	1156A, 1157A, 1158A, N2795A	1130A, 1131A, 1132A, N279xA, N2891A	1146A, 1147A, N2780/1/2/3A ¹
Infiniium 54810/15/20/25A	N2873A	10076B	N2771A	N2870A	N2874A, N2876A	1152A, 1145A ³ , 1156A	1153A ² , N2791A, N2792A, N2793A, N2891A	1146A, 1147A, N2780/1/2/3A
Infiniium 54830/31/32/33B/D, 8000 Series	10073D, N2873A	10076B	N2771A	N2870A	N2874A, N2876A	1156A, 1145A ³ ,	1153A ² , 1130A ⁶ , N279xA, N2891A	1146A, 1147A, N2780/1/2/3A ⁷
Infiniium 54835A, 54845A/B, 54846A/B	N2873A	10076B	N2771A	1162A	N2874A, N2876A	1152A ² , 1145A ³ , 1156A	1153A ² , N2792A, N2793A, 1130/32A ⁶ , N2891A, N2791A	1146A, 1147A, N2780/1/2/3A
54751/52A/B, 54711/12/21/22A	—	—	—	—	54006A	54701A ^{2,4} 54701A ⁴	1141A ³	—
54714/15A/13B	N2873A, 10073D	10076B	N2771A	N2870A, 10070C	N2874A, N2876A	1144A ³ , 1145A ³ , 54701A ⁴	1141A ³	—
54645A/D	10074C, N2871A	10076B	N2771A	10070C	—	1144A ^{2,3} , 1145A ^{2,3}	1141A ^{2,3} , N2791A, N2792A, N2793A, N2891A	1146A, N2780/1/2/3A ⁷
54621A/D, 54622A/D/24A	10074C, N2871A	10076B	N2771A	10070C, N2870A	—	1144A ³ , 1145A ³	1141A ^{2,3} , N279xA, N2891A	1146A, N2774A ⁵
54641A/D, 54642A/D	10073D	10076B	N2771A	10070C	—	1144A ³ , 1145A ³	N2791A, N2792A, N2793A, 1141A, N2891A	1146A, N2780/1/2/3A ⁷
54615/16B/16C	10073D, N2873A	10076B	N2771A	10070C, N2870A	N2874A, N2876A	1144A ³ , 1145A ³	1141A ³ , N2791A	1146A, N2780/1/2/3A ⁷
54610A/B	10073D, N2873A	10076B	N2771A	10070C, N2870A	N2874A, N2876A	1144A ³ , 1145A ³	1141A ³ , N2791A	1146A, N2780/1/2/3A ⁷

¹ Must remove pogo pin and configure scope for probe manually
² Use with 50 ohm termination adapter
³ Requires the 1142A probe power supply
⁴ Requires the 1143A probe offset and power module
⁵ Requires N2775A power supply
⁶ Requires one or more InfiniiMax probe heads or connectivity kit per amplifier
⁷ Requires N2779A power supply

10073D
 10070C
 10074C
 10076A
 N2862A
 N2863A
 N2874A to
 N2876A
 1146A
 1147A
 10076A
 10077A
 54006A
 N2771A
 N2779A to
 N2783A
 1141A
 1142A
 1153A
 1130A to
 1132A
 1134A
 1142A to
 1145A
 1156A to
 1158A
 1168A
 1169A
 E2669A
 N2795A
 N2796A

Web Link

www.agilent.com/find/scope_probes

10073D
10070C
10074C
10076A
N2862A
N2863A
N2874A
N2875A
N2876A



10073D/74D passive probes



N287xA family of passive probes and accessories



N2862/63A low-cost passive probe

10070 Passive Probe Family

The 10070 family of rugged, general purpose probes are designed to operate with the InfiniiVision and 54600 family of oscilloscopes. This family provides a range of high-quality probing solutions at very reasonable prices.

These reliable probes come with one retractable hook tip, eight color identification tags, one ground bayonet, one IC tip, one adjustment tool, and one ground lead.

See page 42 for compatible SMT probing kits.

N287xA Passive Probe Family

The N2870A Series passive probes offer DC to 35, 200, 350, 500 MHz and 1.5 GHz bandwidths and various attenuation factors to address a wide range of measurement needs. For general purpose probing, you can use the N2873A 500 MHz model, which provides superior 10 MΩ input resistance, 9.5 pF of low input capacitance and low-inductance ground connection. This keeps probe loading low enough to achieve high signal integrity measurements. The 1.5 GHz passive probe offers even lower input capacitance for measuring faster edges more accurately, making it a low-cost alternative to an active probe.

The compact design with a 2.5 mm probe tip diameter provides better visibility to the circuit under test than conventional 5 or 3.5 mm probe tips. This makes it easier to probe today's fine pitched space ICs and components. In addition, the replaceable probe tip is spring loaded, keeping it from slipping off the device you are probing.

All N2870A Series probes come with the probe ID readout feature, allowing the probe to be automatically recognized when connected to most Agilent oscilloscopes.

N2862/63A Low-cost Passive Probe Family

The Agilent N2862A and N2863A low-cost passive probes provide a 10:1 attenuation and features a high input resistance of 10 Mohm. The probes can be adjusted for low-frequency compensation and high-frequency compensation. The probes are compatible with wide range of oscilloscopes and provide a high quality probing solution at affordable prices.

Available accessories for N2862A/63A probe: 0960-2900 retractable hook tip for N2862A/63A

Accessories for N287xA Passive Probes

N2877A Deluxe Accessory Kit

The N2877A deluxe accessory kit contains various probe tip accessories, ground leads, probe tip adapter, IC clips and 2-leg probe positioner (N2786A) allowing the N2870A Series passive probes to access signals and components that are difficult to probe.

N2878A General Purpose Accessory Kit

The N2878A general purpose accessory kit offers the most commonly used accessories for N2870A Series passive probes including IC caps, insulating cap, protection cap, ground spring, ground blade, replacement probe tips, copper pads, sprung hook, BNC adapter, 15 cm ground lead and color coded rings. Order this general purpose accessory kit if you need spare parts for the standard accessories supplied with the N2870A Series passive probe.

N2879A Fine Pitch Accessory Kit

The N2879A fine pitch accessory kit offers the ideal set of accessories needed for probing fine pitch ICs and components with N2870A Series passive probes. The kit includes IC caps, insulating cap, protection cap, ground spring, ground blade, replacement probe tips, dual-lead adapters, hook tip adapter, PCB adapters, IC clips, SMD clips and 2-leg probe positioner (N2786A).

N2885A PCB Adapter Kit

The N2885A PCB adapter kit is designed to solder into a printed circuit board (PCB) as test points to minimize ground inductance and maximize signal fidelity. The recommended layout is shown in the user's manual that accompanied the N2870A Series passive probes (Agilent literature number: N2876-97000).

The PCB socket is compatible with hand soldering and reflow processes. After soldering the socket - both the signal contact and ground contact - to the board, simply insert the probe. The PCB adapter is compatible with either rigid or spring-loaded probe tip of the N2870A Series passive probe.

Specifications

Model	Length	Division ratio	Circuit loading (1 MΩ scope input)	Typical scope bandwidth	Compensates oscilloscope input
10070D	1.5 m	1:1	1 MΩ; 70 pF	20 MHz	High impedance
10073D	1.5 m	10:1	2.2 MΩ; 12 pF	500 MHz	1 MΩ; 6 to 15 pF
10074D	1.5 m	10:1	10 MΩ; 15 pF	150 MHz	1 MΩ; 9 to 17 pF
10076B	1.8 m	100:1	66.7 MΩ; 3 pF	250 MHz	1 MΩ; 7 to 20 pF
N2862A	1.2 m	10:1	10 MΩ; 12 pF	150 MHz	5 – 30 pF
N2863A	1.2 m	10:1	10 MΩ; 12 pF	300 MHz	5 – 30 pF

10073D
10070C
10074C
10076A
N2862A
N2863A
N2874A
N2875A
N2876A

Characteristics

Model	Bandwidth	Attenuation ratio	Input C	Input R (scope + probe)	Max input voltage	Scope input coupling	Scope comp range
N2870A	35 MHz	1:1	39 pF (+oscilloscope)	1 MΩ	55 V CAT II	1 MΩ	—
N2871A	200 MHz	10:1	9.5 pF	10 MΩ	400 V CAT I, 300 V CAT II	1 MΩ	10 – 25 pF
N2872A	350 MHz	10:1	9.5 pF	10 MΩ	400 V CAT I, 300 V CAT II	1 MΩ	10 – 25 pF
N2873A	500 MHz	10:1	9.5 pF	10 MΩ	400 V CAT I, 300 V CAT II	1 MΩ	10 – 25 pF
N2874A	1.5 GHz	10:1	1.8 pF	500 Ω	8.5 V CAT I	50 Ω	—
N2875A	500 MHz	20:1	5.6 pF	20 MΩ	400 V CAT I, 300 V CAT II	1 MΩ	7 – 20 pF
N2876A	1.5 GHz	100:1	2.2 pF	5 kΩ	21 V CAT I	50 Ω	—

Ordering Information

10070 Series probe accessories

- 5081-7705 probe tip to BNC (m) adapter
- 5081-7690 replacement parts accessory kit
- 10072A SMT probe accessory kit
- 5081-7697 retractable hook tip for 1007x passive probes
- 10075A 0.5 mm IC probing kit

Other accessories

- 10100C BNC 50 Ω feedthrough
- 11094B BNC 75 Ω feedthrough
- 10240B BNC AC blocking capacitor

N287xA family replacement parts and accessory kits

- 0960-2905 sprung hook adapter 2.5 mm for N2870A, 71A, 72A, 73A, 75A
- 0960-2906 ground lead 15 cm for N287xA Series probes
- 0960-2907 short spring hook 2.5 mm for N2874A and N2876A 1.5 GHz passive probe
- 0960-2908 10 self-adhesive copper-pads 2 X 2 cm for N287xA Series probes
- 0960-2898 dual lead-adaptor for N2870A Series probes
- N2877A deluxe accessory kit for N287xA passive probe
- N2878A general purpose accessory kit for N287xA passive probe
- N2879A fine pitch accessory kit for N287xA passive probe
- N2885A PCB socket adapter kit for N287xA passive probe
- N2862/63B probe replacement part
- 0960-2990 retractable hook tip for N2862/63A

Fine pitch IC probing accessories

- E2613B wedge probe adapter, 0.5 mm, 3-signal, qty 2
- E2614A wedge probe adapter, 0.5 mm, 8-signal, qty 1
- E2615B wedge probe adapter, 0.65 mm, 3-signal, qty 2
- E2616A wedge probe adapter, 0.65 mm, 8-signal, qty 1
- E2643A wedge probe adapter, 0.5 mm, 16-signal, qty 1
- E2644A wedge probe adapter, 0.65 mm, 16-signal, qty 1
- 10467-68701 0.5 mm IC clips for surface SMT parts with lead, spacings of 0.5 mm (0.020 in) to 0.8 mm (0.032 in), qty 4

Web Link

www.agilent.com/find/passiveprobes

1142A
1143A
1144A
1145A
1156A
1157A
1158A
N2795A
N2796A

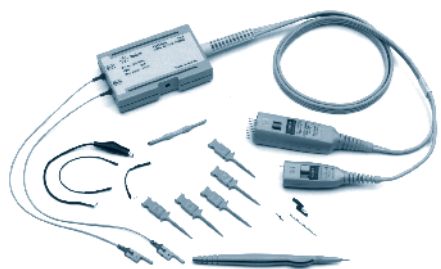

1155A

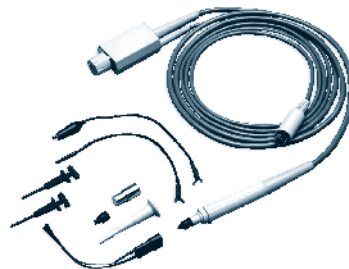

1144A

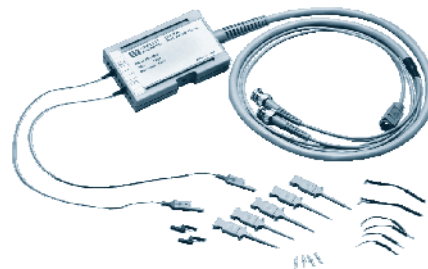

1145A

1155A Low Mass Active Probe for Surface-Mount Devices

The two-channel 1155A low mass active probe for Infiniium oscilloscopes has a probe tip that weighs less than 1 gram, making it ideal for attaching to fine pitch ICs and probing surface mount components.

The probe combines high bandwidth (750 MHz), low input capacitance (2 pF), and high input resistance (1 MΩ) and includes a versatile set of accessories: a browser with a crown point that digs deep in to solder and a spring loaded tip that helps absorb small movements. When used in conjunction with the Agilent wedge, the 1155A provides a hands-free solution for probing 0.5 mm and 0.65 mm IC packages. See page 42 for more information.

1156A/57A/58A Active Probe, 1.5/2.5/4.0 GHz

The Agilent 1156A, 1157A, and 1158A family of active probes offers R & D engineers the performance they need to probe small geometries in hard-to-reach areas on the DUT. These probes were designed specifically for the Infiniium or InfiniVision Series oscilloscopes. As the speeds in your design increase, you may notice more overshoot, ringing, and other perturbations when connecting an oscilloscope probe. Probes form a resonant circuit where they connect to the device. If this resonance is within the bandwidth of the oscilloscope probe you are using, it will be difficult to determine if the measurement perturbations are due to your circuit or the probe.

Agilent is the only company that has overcome the resonance formed by the connection of a probe to a device. The Agilent 1156/57/58A probes optimize performance to make your job easier.

1144A 800 MHz Active Probe

The 1144A features 800-MHz bandwidth, 1 MΩ input resistance, 2 pF input capacitance, 10:1 attenuation, and ±40 Vdc + peak AC maximum-input voltage. The 1144A can access power directly from the 54520 and 54540 Series and the 54615B and 54616B oscilloscopes.

These oscilloscopes provide power for two channels of active probing. If four channels of probing are needed, a special one-input, two-output adapter is available (p/n 01144-61604). Two adapters are needed for four channels of probing. If the 1144A is used with any scope not listed above, then the 1142A power supply is required.

The 01144-61604 adapter can be used with this power supply to provide power for two channels of active probing.

1145A Low Mass Active Probe for Surface-Mount Devices

The two-channel 1145A low mass active probe has a probe tip that weighs less than 1 gram making it ideal for attaching to fine pitch ICs and probing surface mount components. The probe combines high bandwidth (750 MHz), low input capacitance (2 pF) and high input resistance (1 MΩ). A versatile set of accessories are provided and when used in conjunction with the Wedge, the 1145A provides a hands-free solution for probing 0.5 mm and 0.65 mm IC packages. See page 42 for more information.

This probe can access power directly from the 54520/40 Series and 54615/16B oscilloscopes. The 1142A power supply is required for all other instruments. This configuration requires 50 Ohm inputs.

Ordering Information

N2795A 1 GHz active probes

N2796A 2 GHz active probes

1142A power supply for 1141A, 1144A and 1145A

1143A probe offset and power module for 54701A

1144A 800 MHz active probe

1145A 2-channel, 750 MHz active probe

1156A 1.5 GHz active probe

1157A 2.5 GHz active probe

1158A 4 GHz active probe

Web Link

www.agilent.com/find/activeprobes

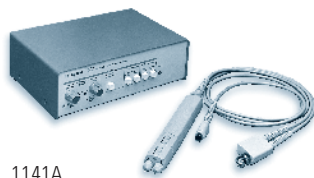

1141A



N2790A

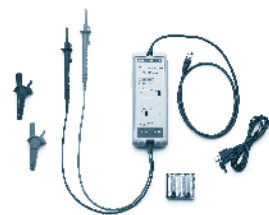

N2791A

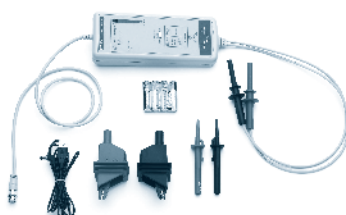

N2891



N2792A



N2793A

1141A Differential Probe with 1142A Power Supply

The 1141A is a 1X FET differential probe with 200 MHz bandwidth and a 3000:1 CMRR (common mode rejection ratio). The probe has a high-input resistance and low-input capacitance of 7 pF to minimize circuit loading. The 1141A must be used with the 1142A probe control and power module, which controls input coupling modes DC, DC with variable offset, and DC reject. Two attenuators, 10X and 100X, are provided to expand the linear differential input range to ± 30 V.

N2790A/91A and N2891A High Voltage Differential Probes

Use N2790A, N2791A or N2891A high voltage differential probe to make safe and accurate floating measurements where neither point of the measurement is at earth ground with an oscilloscope.

Each probe offers user selectable attenuation settings allowing it to be used for a broad range of applications. The probe comes with probe tip accessories for use with small and large components in tight spaces. The N2791A and N2891A are compatible with any oscilloscope with 1 Mohm BNC input. The N2791A and N2891A probe power is supplied by included 4x AA batteries or USB host port of the scope or PC via a supplied USB power cable. The N2790A is compatible with the Agilent's AutoProbe interface where the probe power is supplied by the Agilent oscilloscope's probe interface.

Characteristics for N2790A, N2791A and N2891A Differential Probes

	N2790A	N2791A	N2891A
Bandwidth	100 MHz	25 MHz	70 MHz
Attenuation ratio	50:1 / 500:1	10:1 / 100:1	100:1 / 1000:1
CMRR	-80 dB at 50/60 Hz -50 dB at 1 kHz -50 dB at 1 MHz	-80 dB at 50/60 Hz -40 dB at 1 MHz	-80 dB at 50/60 Hz -60 dB at 20 kHz
Max input voltage to ground	± 1000 V (CAT II) ± 600 V (CAT III)	± 700 V at 100:1 ± 70 V at 10:1	± 7000 V at 1000:1 ± 700 V at 100:1
Max input voltage between two inputs	± 1400 V at 500:1 ± 140 V at 50:1	± 700 V at 100:1 ± 70 V at 10:1	± 7000 V at 1000:1 ± 700 V at 100:1

Characteristics for 1141A Differential Probe

1141A/1153A

Bandwidth	200 MHz
Attenuation ratio with attenuator	10:1 and 100:1
High CMRR	3000:1 at 1-MHz 10:1 at 100-MHz
Max input voltage	200 Vdc + peak AC (probe alone) 500 Vdc + peak AC (with attenuator)

N2792A 200 MHz and N2793A 800 MHz general purpose differential probe
The N2792A (200 MHz) and N2793A (800 MHz) provide the superior general-purpose differential signal measurements required for today's high-speed power measurements, vehicle bus measurements and digital system designs.

The N2792A and N2793A probes offer a 10:1 attenuation setting and high input resistance and low input capacitance to minimize circuit loading. Both probes are compatible with any oscilloscopes with 50 ohm BNC input. The probe can be powered by any USB port on a scope or computer, or by an internal battery.

Characteristics for N2792A and N2793A differential probes

	N2792A	N2793A
Bandwidth	200 MHz	800 MHz
Attenuation ratio	10:1	10:1
CMRR	-80 dB at 50/60 Hz -50 dB at 10 MHz	-60 dB at 50/60 Hz -15 dB at 500 MHz
Max input voltage to ground	± 60 V	± 40 V
Max input voltage between two inputs	± 20 V	± 15 V

Ordering Information

- 1141A** 200 MHz differential probe
- 1142A** power supply for 1141A/1144A/1145A
- N2790A** 100 MHz, 1.4 kV differential probe with AutoProbe interface
- N2791A** 25 MHz, 700 V differential probe
- N2792A** 200 MHz, 20 V differential probe
- N2793A** 800 MHz, 15 V differential probe
- N2891A** 70 MHz, 7,000 V differential probe

Web Link

www.agilent.com/find/differential

1141A
1142A
N2790A
N2791A
N2792A
N2793A
N2891A

N2803A
N2802A
N2801A
N2800A
N5445A
N5439A
N5444A
N5441A
N5425A
1130A
1131A
1132A
1134A
1168A
1169A

- InfiniiMax single-ended/differential probe systems provide 1.5 to 30 GHz of bandwidth, delivering unrivaled performance and real-world usability. Infiniium oscilloscopes, combined with the InfiniiMax probes make up the easiest-to-use and highest performance probing system available for high-speed digital design.



InfiniiMax III probing system

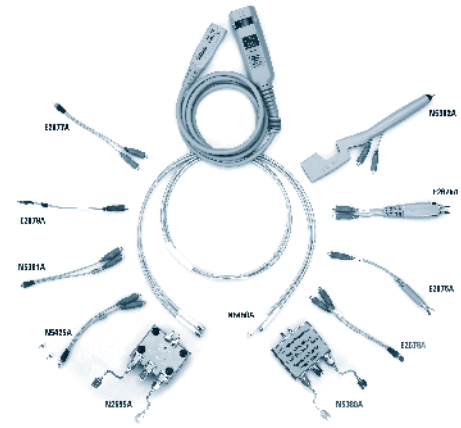

InfiniiMax II probing system with accessories

Specifications

InfiniiMax III probing system – probe amplifiers

	N2803A	N2802A	N2801A	N2800A
Bandwidth	30 GHz	25 GHz	20 GHz	16 GHz
Recommended DSO/DSAX92804A oscilloscope	DSO/DSAX92504A DSO/DSAX93204A	DSO/DSAX92504A	DSO/DSAX92004A	DSO/DSAX91604A
Attenuation	3:1 (with 200 ohm ZIF tip and head), 6:1 (with all other InfiniiMax III probe heads)			
Dynamic range	Up to 2.5 Vpp			
Noise referred to input	2 mV (with 200 ohm ZIF tip and head), 4 mV (with all other InfiniiMax III probe head)			

InfiniiMax III probing system – probe heads

	N5445A	N5439A	N5444A	N5441A
Bandwidth	30 GHz	28 GHz	28 GHz	16 GHz
Description	Hi-BW browser head	Hi-BW ZIF probe head	Hi-BW 2.92 mm/3.5 mm/SMA	Hi-BW solder-in
Notes	Order N5476A for replacement tips	Order N5440A (450 ohm) or N5447A (200 ohm) ZIF tips	Order N5448A 2.92 mm head flex cable	

InfiniiMax I & II probing system – probe amplifiers

	1169A	1168A	1134A	1132A	1131A	1130A
BW Spec	12 – 13 GHz	10 GHz	7 GHz	5 GHz	3.5 GHz	1.5 GHz
Recommended oscilloscope	DSO81304B DSO81204B	DSO81004B DSO80804B	DSO80604B	DSO80404B	DSO80304B DSO80204B	DSO80204B
Attenuation	3.45:1	3.45:1	10:1	10:1	10:1	10:1
Dynamic range	3.3 Vp-p	3.3 Vp-p	5 Vp-p	5 Vp-p	5 Vp-p	5 Vp-p
Noise referred to input	2.5 mV rms	2.5 mV rms	3.0 mV rms	3.0 mV rms	3.0 mV rms	3.0 mV rms

InfiniiMax I & II probing systems with probe heads

	N5380A	N5381A	N5382A	N5425A/ N5426A	N5425A/ N5451A	N2884A	E2675A	E2676A	E2677A	E2678A	E2679A	E2695A
Typ BW	13 GHz	13 GHz	13 GHz	13 GHz	9.9 GHz	13 GHz	6 GHz	6 GHz	12 GHz	12 GHz	6 GHz	8 GHz
Description	Hi-BW differential SMA	Hi-BW differential solder-in	Hi-BW differential browser	Hi-BW differential ZIF solder-in	Long wired ZIF solder-in	Fine-wire probing tip for wafer probing	Differential browser	Single-ended browser	Differential solder-in	Differential socket	Single-ended solder-in	Differential SMA
Diff capacitance		0.21 pF	0.21 pF	0.33 pF		0.33 pF	0.32 pF	0.67 pF	0.27 pF	0.34 pF	0.50 pF	

Other InfiniiMax I & II probe accessories

	N5450A	N2880A	N2881A
Description	InfiniiMax extreme temperature extension cable (allows for probing in temperatures ranging from -55 to 150 °C)	InfiniiMax in-line attenuator kit (pairs of 6 dB, 12 dB and 20 dB attenuators in a kit)	InfiniiMax DC blocking caps (a pair of 30 Vdc blocking caps)

Refer to the InfiniiMax III probing system data sheet (literature number 5990-5653EN) for more details on the InfiniiMax III probing system

Web Link

www.agilent.com/find/infiniimax

Current probes

- AC/DC current measurements up to 100 MHz, 500 A
- Ideal for making accurate AC, DC and impulse current measurements
- Powered by external power supply, battery or AutoProbe interface

High-voltage passive probes

- High-voltage measurement up to 30 kV DC + peak AC
- Compatible with any scope with 1 Mohm BNC input



Compatible with any oscilloscope with a high-impedance BNC input, the N2780A Series current probes offer an accurate and reliable solution for measuring DC and AC currents



10076B 100:1 high-voltage probe

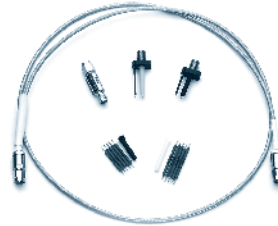

54006A 6-GHz passive divider probe



N2771A
1000:1 high-voltage probe



1146A oscilloscope AC/DC current probe

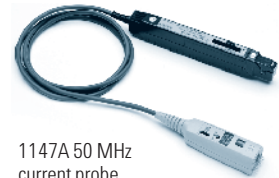

1147A 50 MHz current probe

1146A
1147A
10076A
10077A
54006A
N2771A
N2779A to
N2783A

10076A 100:1 High-Voltage Probe

The 10076A 4 kV 100:1 passive probe gives you the voltage and bandwidth you need for making high-voltage measurements. Its compact design makes it easier to probe today's small power electronics components and its durable construction means it can withstand rough handling. The 250 MHz probe bandwidth enables you to capture fast, high-voltage signals. The 10077A accessory kit can be used with this high voltage probe for wider range of application.

54006A 6-GHz Passive Divider Probe

The low 0.25 pF input capacitance and sophisticated ground design of the 54006A probe lets you probe multi-GHz systems with minimal loading of the circuit under test. The small size of this probe also allows you to access very small components. The 54006A is supplied with 10:1, 500 Ω, and 20:1, 1 kΩ resistive dividers.

N2771A 1000:1 High-Voltage Probe

The N2771A 1000:1 high voltage probe measures fast high voltage signals, up to 30 kV DC + peak AC, 10 kVrms and 50 MHz probe bandwidth.

The probe's large size and rugged construction provides superior protection. The ground lead is fed through the body of the probe and protrudes behind the safety barrier, keeping the ground connection away from the high voltage.

1146A Oscilloscope AC/DC Current Probe

This AC/DC current probe expands oscilloscope applications into industrial, automotive or power environments, and is ideal for analysis and measurement of distorted current waveforms and harmonics.

This probe permits accurate display and measurement of currents from 100 mA to 100 A rms, DC to 100 kHz without breaking into the circuit. Compatible with any scope or voltage measuring instrument with BNC input, 0.2 to 0.5 V/div, and a minimum input impedance of 1 MOhm. 1 mV/100 mA range; output signal: 10 mV/A AC/DC. 1 mV/10 mA range; output signal: 100 mV/A AC/DC. Working voltage: 660 V max., battery: 9 V alkaline.

Hybrid Technology for AC and DC Measurements

Using hybrid technology that includes a Hall-effect sensor and an AC current transformer, the probes provide accurate measurement of DC or AC currents up to 500 Arms peak (for model N2780A) or DC – 100 MHz (for model N2783A), without breaking into the circuit. Using split core construction, the probe easily clips on and off of a conductor.

Wide Range of Applications

The current probes feature broad measurement ranges (up to 500 A), flat frequency response, low noise and low insertion loss making them ideal for measuring steady state or transient current of motor drives, switching power supplies, inverters, controllers, sensors, disk drives, LCD displays, electronic ballasts and amplifiers. The high signal-to-noise ratio of the N2782A and N2783A makes them ideal for making low-level current measurements in milliamphere ranges.

Accurate Current Measurement

A built-in DEMAG (demagnetize) function allows the removal of any residual magnetism that has built up in the magnetic core due to power on/off switching or excessive input current. In addition, voltage offset or temperature drift on the probe can be easily corrected by using the zero adjustment control.

1147A 50 MHz Current Probe

The Agilent 1147A is a wide bandwidth, active current probe for Infiniium or InfiniiVision Series oscilloscopes with AutoProbe interface. The probe features flat bandwidth (DC – 50 MHz), low noise (< 2.5 mA rms) and low circuit insertion loss. The 1147A is ideal for capturing transient current signals such as those found in motor controllers, in switching power supplies, inverters and current amplifiers driving inductive loads.

Ordering Information

- N2780A 2 MHz/500 A AC/DC current probe
- N2781A 10 MHz/150 A AC/DC current probe
- N2782A 50 MHz/50 A AC/DC current probe
- N2783A 100 MHz/50 A AC/DC current probe
- N2779A 3-channel power supply for N2780A Series current probes
- 1146A 100-kHz AC/DC current probe
- 1147A 50 MHz/15 A AC/DC current probe with AutoProbe interface
- 10076A 100:1 high voltage probe
- 10077A accessory kit for 10076A
- 54006A 6-GHz passive divider probe
- N2771A 1000:1 high voltage probe

Web Link

www.agilent.com/find/currentprobes

N2784A to
N2787A
10072A
E2613A
E2613B
E2614A
E2615A
E2615B
E2616A
E2643A
E2644A

- Easy connection to 0.5 mm, 0.65 mm TQFP and PQFP packages
- Reliable contact with little chance of shorting to adjacent pins
- Mechanically noninvasive
- Can be inserted while the board is active
- 3, 8, and 16-signal versions

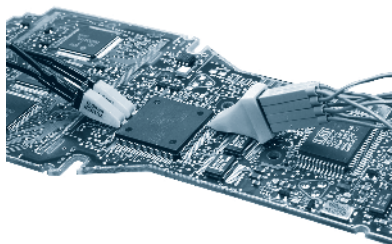

At one end, wedge conductor segments are inserted into the space between IC pins; at the other end, they easily connect to scopes and logic analyzers

Wedge Probe Adapter

Precise Problem-Free Probing

The Agilent wedge probe adapter solves the problem of connecting your scope or logic analyzer to fine pitch thin quad flat pack (TQFP) and plastic quad flat pack (PQFP) surface mount ICs. It provides accurate, mechanically noninvasive and reliable electrical contact to 0.5 and 0.65 mm IC packages, with little chance of shorting. It is available in 3-, 8-, and 16-signal versions.

Easy to Insert, Then Stays Put

It works by inserting compressible dual conductors between adjacent IC pins. The flexible conductors conform to the size and shape of each leg to ensure tight contact. Then simply connect your scope or logic analyzer to the Agilent wedge.

Electrical Reliability

The wedge's unique design delivers secure redundant contact on each pin, with little chance of shorting to adjacent pins. The redundant physical connection created by two contact points on each pin of the IC and its short electrical length dramatically increases the reliability of the electrical connection. Since the Agilent wedge doesn't latch directly onto the IC and doesn't require expansion beforehand (as a clip does), it can be inserted while the board is active. Plus, it's mechanically noninvasive so it won't damage your device under test.

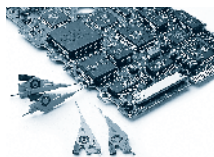

10467-68701
0.5 mm IC clips



10467-68701
0.5 mm IC clips

0.5 mm IC Clips

These IC clips are the smallest in the industry to date and are suitable for connecting to PQFP and SOIC SMT packages from 0.5 – 0.8 mm pitch. The thin body allows clips to be mounted side by side for probing adjacent IC pins. They are suitable for use with all Agilent oscilloscope probes and logic analyzers and have a maximum input voltage of ± 40 V (DC + peak AC).

10075A and 10467-68701 0.5 mm IC Clip Accessory Kit

The 10075A includes four 0.5 mm IC clips (10467-68701) and two dual-lead adapters for use with passive probes. Plug the probe tip into one end of the adapter and connect the IC clip to the other end. The 10075A is compatible with the 10070A family of passive probes. The 10467-68701 is compatible with the 10400A family of passive probes. The 1160A and 10400B family of probes include a dual-lead adapter as a standard accessory. For these probes the accessory kit is not required.

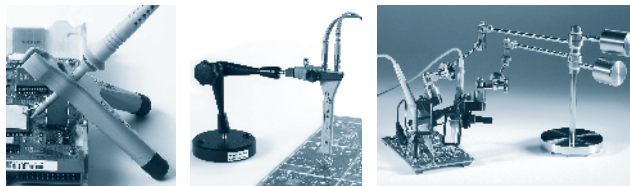

Probe positioners

10072A SMT Probe Accessory Kit

The 10072A includes 10 SMT lead clips that adapt the 10070A family of low-cost probes to fine-pitch devices.

The 10072A includes 10 SMT lead clips that adapt the 10070A family of low-cost probes to fine-pitch devices.

N2784A and N2785A Quick XY Probe Positioners

The N2784A and N2785A probe positioners provide quick and stable X-Y positioning to PC boards and devices that require hands-free probing.

Unlike other probe positioners that require multiple adjustments to lock into position, these need only a "lift and drop" motion to position in place. The weight stabilization technique used in the probe holder keeps constant pressure at the probing point so the probe tip stays in position even when the target board is bumped.

The N2784A and N2785A are compatible with most Agilent scope probes, including InfiniiMax single-ended or differential browsers. They are also compatible with probes manufactured by other vendors. The N2784A comes with a single-positioning arm while the N2785A comes with two positioning arms.

Low-Cost Two-Legged Positioner – N2786A

The N2786A is a low-cost, easy-to-use XY axis probe holder for general purpose probing applications. The two-legged positioner is easy-to-use without controls to position it in place. This positioner has three different sized apertures into which various sized probes can be placed. All of Agilent's 2.5 mm and 5 mm passive probes such as 10073C, N2862A, 1165A etc. and most other passive probes in the market can be used with the N2786A positioner.

3D Positioner – N2787A

The N2787A is a 3D probe positioner with a flexible, articulating arm that can be quickly positioned in a wide variety of configurations. It also allows fine-adjustment to the probe location to obtain stable contact. This universal probe holder fits most Agilent passive and active probes, including InfiniiMax single-ended or differential browsers.

Ordering Information

- E2613A wedge probe adapter, 0.5 mm 3-signal, qty 1
- E2613B wedge probe adapter, 0.5 mm 3-signal, qty 2
- E2614A wedge probe adapter, 0.5 mm 8-signal, qty 1
- E2615A wedge probe adapter, 0.65 mm 3-signal, qty 1
- E2615B wedge probe adapter, 0.65 mm 3-signal, qty 2
- E2616A wedge probe adapter, 0.65 mm 8-signal, qty 1
- E2643A wedge probe adapter, 0.5 mm 16-signal, qty 1
- E2644A wedge probe adapter, 0.65 mm 16-signal, qty 1
- 10467-68701 0.5 mm IC clips, qty 4
- 10072A SMT probe accessory kit
- N2784A 1-positioning arm probe positioner
- N2785A 2-positioning arm probe positioner
- N2786A 2-legged probe positioner
- N2787A 3D probe positioner

Web Link

www.agilent.com/find/probe_positioners

- More than 65 powerful application software packages
- Application expertise because Agilent engineers participate in key industry standards bodies
- Automated setup and one-button compliance testing for more than 25 applications

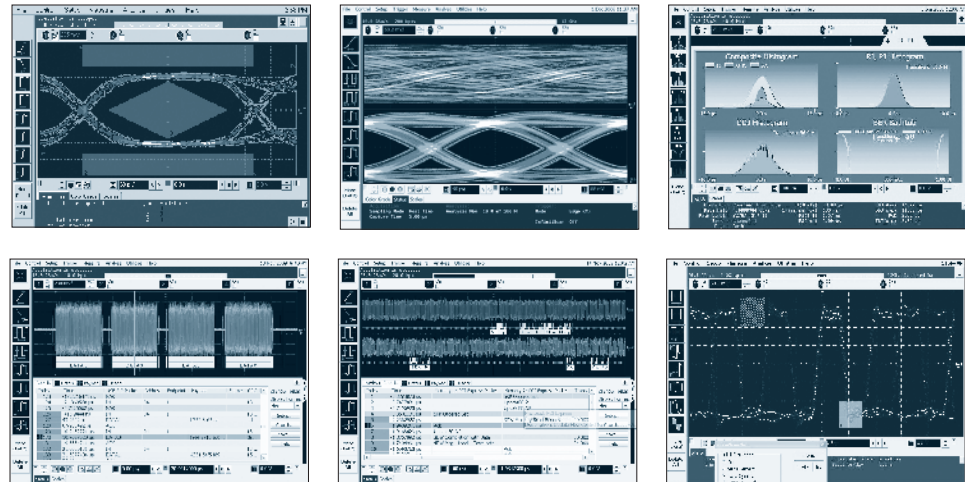

5000 Series
6000 Series
7000B Series
9000 Series
9000A Series
90000 Series
X-Series

Specifications

Area	Part number	Name	Description
Compliance	U7236A	10GBASE-T Ethernet compliance	Fast and accurate way to verify and debug 10GBASE-T Ethernet designs on Infiniium oscilloscopes
Compliance	U7233A	DDR compliance	Solution supporting the latest DDR1 specification for Infiniium oscilloscopes
Compliance	N5413B	DDR2 and LPDDR2 compliance	Solution for clock and data characterization for Infiniium oscilloscopes
Compliance	N5413A	DDR2 compliance	Solution supporting the latest DDR2 specification for Infiniium oscilloscopes
Compliance	U7232A	DDR3 compliance	Solution supporting the latest DDR3 specification for Infiniium oscilloscopes
Compliance	N5394A	DVI compliance	Solution supporting the latest DVI specification for Infiniium oscilloscopes
Compliance	N5392A	Ethernet compliance	Solution supporting the latest Ethernet specification for Infiniium oscilloscopes
Compliance	N5410A	Fibre channel compliance	Solution supporting the latest Fibre-Channel specification for Infiniium oscilloscopes
Compliance	N5409A	Fully buffered DIMM compliance	Solution supporting the latest FB-DIMM specification for Infiniium oscilloscopes
Compliance	N5399B	HDMI compliance	Solution supporting the latest HDMI for Infiniium oscilloscopes
Compliance	N5399A	HDMI compliance	Solution supporting the latest HDMI specification for Infiniium oscilloscopes
Compliance	U7238A	MIPI D-PHY compliance test software	Solution supporting the latest MIPI D-PHY specification for Infiniium oscilloscopes
Compliance	N5393B	PCI Express compliance	Solution supporting the latest PCI Express specification for Infiniium oscilloscopes
Compliance	N5412A	SAS compliance	Compliance application for Serial attached SCSI (SAS)
Compliance	N5411A	SATA compliance	Solution supporting the latest SATA specification for Infiniium oscilloscopes
Compliance	U7239A	Ultra-Wideband compliance	MB-OFDM ultra wideband (UWB) physical layer (PHY) validation and compliance software for Infiniium Series oscilloscopes
Compliance	N5416A	USB 2.0 compliance	Solution supporting the latest USB 2.0 specification for Infiniium oscilloscopes
Compliance	U7243A	USB 3.0 compliance	Solution supporting the latest USB 3.0 specification for Infiniium oscilloscopes
Compliance	N5431A	XAUI compliance	Solution supporting XAUI and 10GBASE-CX4 for Infiniium oscilloscopes
Protocol	N8803A	CAN, LIN and FlexRay protocol triggering and decode	CAN, LIN and FlexRay physical layer conformance test package for Infiniium 90000 oscilloscopes
Protocol	N8803B	CAN, LIN and FlexRay protocol triggering and decode	CAN, LIN and FlexRay physical layer conformance test package for Infiniium 9000 oscilloscopes
Protocol	N5391B	I ² C and SPI protocol triggering and decode	I ² C and SPI protocol analysis application for Infiniium 9000 oscilloscopes
Protocol	N8817A	JTAG protocol decode	JTAG (IEEE 1149.1) protocol decode for Infiniium oscilloscopes
Protocol	N8802A	MIPI D-Phy protocol trigger and decode	MIPI D-Phy protocol analysis application for Infiniium oscilloscopes
Protocol	N5463B	PCI Express protocol triggering and decode	PCI Express protocol analysis application for Infiniium 9000 oscilloscopes
Protocol	N5463A	PCI Express protocol triggering and decode	PCI Express protocol analysis application for Infiniium 90000 oscilloscopes
Protocol	N5462B	RS-232/UART protocol triggering and decode	RS-232 protocol analysis application for Infiniium 9000 oscilloscopes
Protocol	N5462A	RS-232/UART protocol triggering and decode	RS-232 protocol analysis application for Infiniium 90000 oscilloscopes
Protocol	N8803A	SATA protocol trigger and decode	SATA protocol analysis application for Infiniium oscilloscopes
Protocol	N5464B	USB protocol triggering and decode	USB protocol analysis application for Infiniium 9000 oscilloscopes
Protocol	N5464A	USB protocol triggering and decode	USB protocol analysis application for Infiniium 90000 oscilloscopes

5000 Series
6000 Series
7000B Series
9000 Series
90000A Series
90000 Series
X-Series

Serial	N5424A	CAN/LIN option	Hardware enabled trigger and decode of CAN/LIN
Serial	N5432C	FlexRay triggering and decode	FlexRay physical layer conformance test package for InfiniiVision oscilloscopes
Serial	N5384A	High-speed serial data analysis	Serial data analysis to validate signal integrity for Infiniium oscilloscopes
Serial	N5391A	I ² C and SPI protocol triggering and decode	Hardware enabled trigger and decode of I ² C and SPI for 90000 oscilloscopes
Serial	N5468A	I ² S triggering and decode	I ² S physical layer conformance test package for InfiniiVision oscilloscopes
Serial	N5469A	MIL-STD 1553 triggering and decode	MIL-STD 1553 physical layer conformance test package for InfiniiVision oscilloscopes
Serial	N5457A	RS-232/UART triggering and decode	RS-232/UART physical layer conformance test package for InfiniiVision oscilloscopes
Serial	E2688A	Serial data analysis/mask testing	Serial data analysis for 90000 oscilloscopes
Debug	U1882A	Power measurement	Automatic and reliable characterization of switching mode power supplies for Infiniium oscilloscopes
Debug	E2681A	EZJIT jitter analysis	Real-time jitter trend, histogram and spectrum displays
Debug	N5400A	EZJIT Plus jitter	Real-time jitter trend, histogram and spectrum displays RJ/DJ separation and automated data rate
Debug	N5433A	FPGA dynamic probe for Altera	Rapid debug of designs with Altera FPGAs
Debug	N5434A	FPGA dynamic probe for Altera	Rapid debug of designs with Altera FPGAs
Debug	N5397A	FPGA dynamic probe for Xilinx	Rapid debug of designs with Xilinx FPGAs
Debug	N5406A	FPGA dynamic probe for Xilinx	Rapid debug of designs with Xilinx FPGAs
Debug	N5415B	InfiniiScan event identification	Industry's first software triggering solution including the "Zone Trigger" feature for the 8000 Series
Debug	N5415A	InfiniiScan event identification	Industry's first software triggering solution including the "Zone Trigger" feature for the 90000 Series
Debug	N5465A	InfiniiSim waveform transformation toolset	Simulate and view waveforms on the Infiniium oscilloscopes
Debug	N5461A	Infiniium serial data equalization	Depicts both feed-forward equalization (FFE) and decision feedback equalization (DFE) on Infiniium oscilloscopes
Debug	N5430A	Infiniium user defined function	Develop powerful custom analysis functions with this gateway to MATLAB for Infiniium oscilloscopes
Debug	N5455A	Mask/waveform limit testing	Fast and easy way to test signals to specified standards and uncover unexpected signal anomalies on InfiniiVision oscilloscopes
Debug	Option-061	MATLAB basic oscilloscope package	MATLAB data analysis software
Debug	Option-062	MATLAB standard oscilloscope package	MATLAB data analysis software with signal processing toolbox and filter design toolbox
Debug	B4610A	Offline viewing and analysis	View and analyze captured data while the InfiniiVision oscilloscope's data acquisition hardware is used for making other measurements
Debug	U1881A	Power measurement	Automatic and reliable characterization of switching mode power supplies for InfiniiVision oscilloscopes
Debug	N5436A	Protocol viewer	View and correlate analog and digital domains when analyzing serial data streams
Debug	U7241A	QPI electrical performance and validation	Software to help you verify and debug your Intel® QPI interconnect designs
Debug	N5452A	Remote programming interface	Connect your PC to your compliance application on Infiniium 90000 oscilloscopes
Debug	N5454A	Segmented memory acquisition	InfiniiVision oscilloscopes are the first to provide segmented memory acquisitions simultaneously on all analog channels
Debug	N5467A	User-defined application (UDA)	Fully customizable automated application for Infiniium oscilloscopes
Debug	89601A	Vector signal analysis	Vector signal analysis of data rates up to 480 Mbps
Debug	89601A-BHB	VSA UWB (MB-OFDM) modulation analysis	MB-OFDM ultra-wideband modulation analysis
Debug	N5414B	InfiniiScan event identification	Industry's first software triggering solution including the "Zone Trigger" feature for the 80000 Series

Web Link

www.agilent.com/find/scope-apps



Agilent Technologies offers a complete line of analyzers that provide frequency-, time-, order-, angle-, and modulation-domain measurement capabilities. The instruments in the following section are devoted primarily to the frequency-domain.

Signal and Spectrum Analyzers

Traditionally, spectrum analyzers are referred to as swept-tuned, super-heterodyne receivers that provide a display of amplitude versus frequency. Modern day analyzers offer both swept-tuned and FFT architectures. While the terms spectrum analyzer and signal analyzer are still used interchangeably, signal analyzer appears to be a more accurate term for the modern day analyzers that provide more comprehensive signal analysis not only in frequency-domain but also time-, and modulation-domains.

Technology breakthroughs have enabled modern day signal/spectrum analyzers to achieve wider analysis bandwidth, wider dynamic range, higher sensitivity, higher measurement accuracy, and better overall RF characteristics. Many offer advanced measurement applications to simplify specialized measurements and functions, such as demodulating signals based on standards and characterizing phase noise or noise figure performance of a device or subsystem. The following are just some of the measurements that can be made accurately with modern day signal/spectrum analyzers: absolute and relative frequency, absolute and relative amplitude, noise, spurious and distortion products, AM, FM, Φ M, pulsed modulation, and digital modulation.

Agilent X-Series Signal Analyzers

Agilent's X-Series signal analyzers are driving signal/spectrum analysis into the next generation. In real-world signal analysis, the ability to evolve equals success and the X-Series signal analyzers are ready to evolve as technology changes. With an upgradable CPU module, memory, data storage, and I/O ports, you can keep your test assets up-to-date and extend instrument longevity. The X-Series signal analyzers, ranging from the high-performance (PXA), mid-range (MXA), economy-class (EXA), to the low-cost (CXA), share the same user interface, and code sets. This allows you to move along the performance curve today and tomorrow without rewriting your test code, while optimizing price and performance for whichever technologies you're pursuing. Adding functionality or applications to the X-Series' reliable and robust hardware architecture is simply a license-key upgrade that allows for increased instrument capability with no downtime.

Vector Signal Analyzer

While traditional spectrum analyzers usually make scalar measurements, vector signal analyzers (VSA) retain both magnitude and phase information for the signals under tests, enabling in-depth modulation analysis. VSAs offer fast, high-resolution spectrum measurements, demodulation, and advanced time-domain and code-domain analysis. They are especially useful for characterizing complex signals such as burst, transient, or modulated signals used in communications, video, broadcast, sonar, radar, satellite, and imaging applications.

Dynamic Signal (Fourier) Analyzers

Fourier analyzers offer fast, high-resolution spectrum and network analysis. Unlike conventional spectrum analyzers, Fourier-based analyzers can measure all frequencies simultaneously, not just one at a time. Fourier analyzers are especially useful on low-frequency signals (< 100 kHz) or where very fast measurements are desired. Applications include acoustic, modal, vibration, or rotating machine analysis.

Dedicated Signal Analysis Solutions

Agilent also offers a variety of signal analysis solutions that are dedicated to specialized applications:

- Signal source analyzers and phase noise measurement systems provide exceptionally low internal phase noise floor across very wide offset frequency, which ensures that you accurately characterize the phase noise performance of the devices, sub-systems, and systems.
- Measuring receivers provide metrology-grade measurements including frequency counter, precision RF power measurements, analog demodulation, and audio analysis. They are most suitable for traceable calibrations of signal generators and attenuators.
- EMI measurement receivers have built-in standard-compliant filters, detectors, and other features that help the electromagnetic emission and radiation tests be made faster, easier, and more accurately.

Key Specification Comparison Table

This condensed comparison guide contains Agilent signal and spectrum analyzers. For the full comparison of signal/spectrum analyzer capabilities, please visit www.agilent.com/find/sa or the individual product web sites or their respective sections in this catalog.

	Agilent PXA N9030A	Agilent MXA N9020A	Agilent EXA N9010A	Agilent CXA N9000A	Agilent PSA E444xA	Agilent 856xEC 856xEC	Agilent ESA E44xxB	Agilent N9320B N9320B	Agilent HSA N9340B (N9342C)
Performance	◆◆◆◆	◆◆◆◆	◆◆◆	◆◆	◆◆◆◆◆	◆◆◆◆	◆◆◆	◆	◆
Frequency range	3 Hz – 26.5 GHz	20 Hz – 26.5 GHz	9 kHz – 26.5 GHz	9 kHz – 7.5 GHz	3 Hz – 50 GHz	30 Hz – 50 GHz	100 Hz ¹ – 26.5 GHz	9 kHz – 3 GHz	100 kHz – 7 GHz
Warm-up time	30 min	30 min	30 min	30 min	30 min	5 min	5 min	30 min	30 min
Phase noise at 1 GHz (10 kHz offset)	-129 dBc/Hz	-103 dBc/Hz	-99 dBc/Hz	-100 dBc/Hz	-116 dBc/Hz	-113 dBc/Hz	-98 dBc/Hz	-88 dBc/Hz	-87 dBc/Hz (30 kHz offset)
Phase noise at 1 GHz (1 MHz offset)	-145 dBc/Hz	-135 dBc/Hz	-132 dBc/Hz	-120 dBc/Hz	-145 dBc/Hz	N/A	-127 dBc/Hz	-112 dBc/Hz ²	-119 dBc/Hz ²
Maximum third order dynamic range, 1 GHz	115 dB	110 dB	108 dB	102 dB	113 dB	108 dB	108 dB	93 dB	89 dB
Displayed average noise at 1 GHz	-165 dBm ³ -172 dBm ^{3,4}	-163 dBm ³	-161 dBm ³	-157 dBm ³	-168 dBm ³	-151 dBm	-153 dBm ^{2,3}	-145 dBm ³	-159 dBm ³
Displayed average noise at 4 GHz	-164 dBm ³ -172 dBm ^{3,4}	-162 dBm ³	-160 dBm ³	-155 dBm ³	-165 dBm ³	-147 dBm	-148 dBm ⁵	N/A	-158 dBm ³
Standard attenuator range/step	70 dB/2 dB	70 dB/2 dB	60 dB/10 dB	50 dB/10 dB	70 dB/2 dB	70 dB/10 dB	75 dB/5 dB	70 dB/1 dB	51 dB/1 dB
Overall amplitude accuracy	±0.19 dB ⁶	±0.23 dB ⁶	±0.27 dB ⁶	±0.50 dB ⁶	±0.19 dB ⁶	±1.9 dB	±0.40 dB ⁶	±1.5 dB	±1.5 dB
Resolution bandwidth	1 Hz – 8 MHz	1 Hz – 8 MHz	1 Hz – 8 MHz	1 Hz – 8 MHz	1 Hz – 8 MHz	1 Hz – 2 MHz	1 Hz – 5 MHz	10 Hz – 1 MHz	10 Hz – 3 MHz
Standard analysis bandwidth	10 MHz	10 MHz	10 MHz	10 MHz				1 MHz	1 MHz
Optional RF analysis bandwidth	25, 40, 140 MHz	25, 40 MHz	25, 40 MHz	25 MHz	10, 40, 80 MHz		10 MHz ⁷		
Optional baseband analysis bandwidth		25 MHz 40 MHz							
Battery							• ¹		•

One-Button Power Measurements (PowerSuite)

	Agilent PXA	Agilent MXA	Agilent EXA	Agilent CXA	Agilent PSA	Agilent 856xEC	Agilent ESA	Agilent N9320B	Agilent HSA
Channel power	•	•	•	•	•	•	•	•	•
Occupied bandwidth	•	•	•	•	•	•	•	•	•
Multicarrier, multi-offset ACP	•	•	•	•	•		•	•	•
Multicarrier power	•	•	•	•	•		•		
CCDF	•	•	•	•	•		•		
Harmonic distortion	•	•	•	•	•	• ¹	•		
Burst power	•	•	•	•	•		•		
Intermodulation (TOI)	•	•	•	•	•	• ¹	•	•	
Spurious emissions	•	•	•	•	•		•	•	
Spectrum emission mask	•	•	•	•	•		•	•	•

¹ Optional

² Typical

³ With optional built-in preamp

⁴ With noise floor extension (NFE)

⁵ With Options 1DR and 1D5. No preamplifier above 3 GHz for E44xxB

⁶ 95th percentile

⁷ With optional B7D/B7E

Measurement Applications and Optional Features

		Agilent PXA	Agilent MXA	Agilent EXA	Agilent CXA	Agilent PSA	Agilent 856xEC	Agilent ESA	Agilent N9320B	Agilent HSA	89600B VSA
General purpose	AM/FM tune and listen	•	•	•	•		•	•	•	•	
	Analog demodulation	•	•	•	•		•	• ¹	•	•	•
	Cable fault location							•			
	Cable TV							•			
	EMC basic features	•	•	•	•	•					
	EMI	•	•	•	•						
	Enhanced display package	•	•	•	•					•	•
	External source control		•	•	•	•					
	Flexible digital modulation analysis	•	•	•	•	•		•	• ²	• ²	•
	MATLAB software package	•	•	•	•	•					
	Noise figure	•	•	•	•	•		•			
	Phase noise	•	•	•	•	•	•	•			
	Pulse measurement	•	•	•	•	•					
	Remote language compatibility for 856xE/EC and 8566/68 application	•	•	•		•					
	SCPI language capability, FSP/FSU/FSE	•	•	•							
Tracking generator				•			•	•	•		
Cellular communications	1xEV-DO		•	•		•					•
	cdma2000®		•	•		•					•
	GSM/EDGE and EDGE Evolution	•	•	•	• ³	• ³		• ³			•
	LTE FDD and TDD	•	•	•							•
	TD-SCDMA with HSDPA/8PSK	•	•	•	•	•					•
	W-CDMA/HSPA/HSPA+	•	•	•	• ⁴	• ⁴					•
Wireless networking	Bluetooth®	•	•	•	•			•			•
	Fixed WiMAX™		•	•							•
	Mobile WiMAX™	•	•	•	•						•
	WLAN	•	•	•	•	•					•
Digital video	CMMB	•	•	•	•						
	DTMB	•	•	•	•						
	Digital cable TV	•	•	•	•						
	DVB-T/H/ T2	•	•	•	•						
	ISDB-T	•	•	•	•						

Connectivity

	Agilent PXA	Agilent MXA	Agilent EXA	Agilent CXA	Agilent PSA	Agilent 856xEC	Agilent ESA	Agilent N9320B	Agilent HSA	89600B VSA
89600B VSA software link	•	•	•	•	•		•			
Remote interface RS-232							•			
GPIB	• ⁵	• ⁵	• ⁵	• ⁵	•	•	•	•		
LAN	1,000	1,000	1,000	100	10			10	10	
USB	2.0	2.0	2.0	2.0	2.0 ⁶			1.1	1.1	
Removable data storage	USB	USB	USB	USB	3.5" floppy	Memory card	3.5" floppy	USB	USB	
		Solid state drive	Solid state drive	Solid state drive						
LXI	C	C	C	C						

¹ FM demodulation only² ASK/FSK demodulation analysis only³ GSM/EDGE only, EDGE evolution not supported⁴ W-CDMA/HSPA only, HSPA+ not supported⁵ Switchable between master and slave⁶ Device side (type B) for data transfer only; not for use with USB flash drive

Dynamic Analyzers

Frequency range	Channel match	Frequency resolution in lines	Real-time bandwidth	Dynamic range	Amplitude accuracy* (\pm)	Model number	Page
0.000122 Hz to 102.4 kHz	± 0.04 dB, $\pm 0.5^\circ$	100 to 1600	25.6 kHz	80 dB (90 dB typical)	0.15 dB	35670A	166

* Relative accuracy = relative frequency response + lesser of either scale fidelity or IF gain accuracy

Vector Signal Analyzers

Frequency range	Maximum analysis bandwidth	Sensitivity (displayed average noise level)	Dynamic range (3rd order IMD)	Modulation analysis	Signal capture memory	Model number	Page
DC to 50 GHz*	Up to 32 GHz*	-168 dBm/Hz* (at 1 GHz)	-75 dBc*	PC software linked to ESA, PSA, MXA, EXA, PXA, CXA analyzers or Infiniium Series oscilloscopes. Flexible, in-depth analysis of > 70 signal formats	Up to 1.2 GB (384 Msa, complex)	89600B	61

* Depends on analyzers or oscilloscopes linked to the 89600B VSA software

Signal Source Analyzers/Phase Noise Measurement Solutions

Frequency range	Phase noise sensitivity (depends on offset frequency)	Functions available	Model number	Page
10 MHz to 7 GHz/ 26.5 GHz*/110 GHz**	-135 dBc/Hz @ 1 kHz offset to -178 dBc/Hz @ 10 MHz offset (@ 1 GHz, SPD)	Phase noise, frequency, RF power, DC current, frequency/phase/power transient, AM noise, baseband noise	E5052B	159
50 kHz to 110 GHz ²	-180 dBc/Hz @ >10 kHz offset (typical)	Phase noise, AM noise, residual noise, low level spurious signals: 0.01 Hz to 100 MHz offsets	E5505A	

* with E5053A

** with external mixers

Measuring Receiver – Signal Generator and Attenuator Calibration

Frequency range	Maximum amplitude measurement range	Functions available	Model number	Page
100 kHz to 50 GHz	+30 to -140 dBm	Frequency counter, absolute RF power, tuned RF level, AM depth, FM/PM deviation, modulation rate, modulation distortion, and audio signal analysis (optional)	N5531S	64

EMI Measurement Receiver

Frequency range	Amplitude accuracy	Frequency accuracy	Functions available	Model number	Page
3 Hz to 6.7, 13.2, 26.5, 42.98, 44, or 50 GHz	< 1.0 dB (9 kHz to 1 GHz)	< 0.2% Typical < 0.02%	CISPR 16 & Mil Std 461 detectors and bandwidths. Limit lines, amplitude corrections, zoom display, measure at marker	N9039A ¹	63

¹ When used with PSA Series spectrum analyzer and PSA Option 239 EMI receiver measurement personality

Audio Analyzer

Frequency range	Residual distortion + noise (20 Hz to 20 kHz)	Amplitude accuracy	Functions available	Model number	Page
DC, 10 Hz to 100 kHz (analyzer) 5 Hz to 80 kHz (source)	-101 dB (analyzer) -95 dB (source)	$\pm 1\%$	Signal-to-noise ratio, SINAD, THD+N ratio, THD+N level, crosstalk, phase measurement, AC level, DC level, amplitude/frequency sweep and FFT analysis	U8903A	73

Web Link

www.agilent.com/find/sa

www.agilent.com/find/vsa

www.agilent.com/find/35670A

www.agilent.com/find/phasenoise

www.agilent.com/find/N5531S

www.agilent.com/find/emc

www.agilent.com/find/audioanalyzer

- Industry-leading 140 MHz analysis bandwidth with up to 75 dB spurious-free dynamic range
- -172 dBm DANL with noise floor extension (NFE) technology
- -129 dBc/Hz phase noise performance at 10 kHz offset
- ±0.19 dB typical absolute amplitude accuracy
- Versatile library of measurement applications plus VSA software
- Investment protection with upgradeability of future-ready architecture

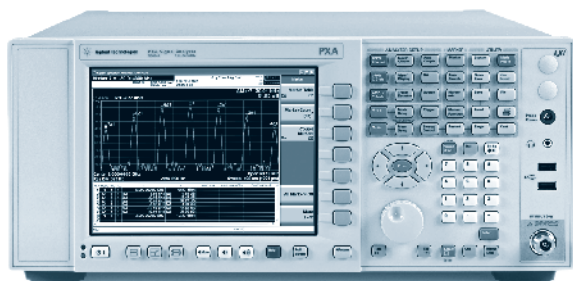

N9030A PXA high performance signal analyzer

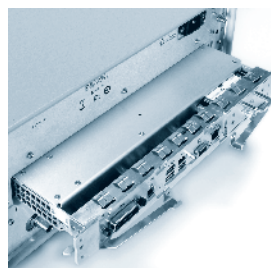

Removable CPU module on PXA

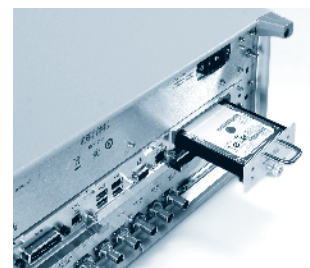

Removable solid state drive on PXA simplifies data security

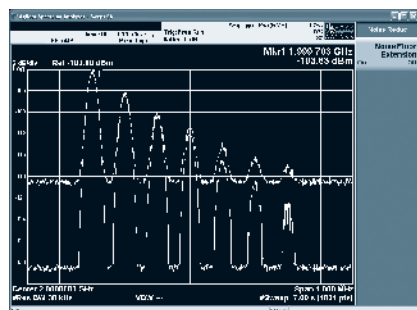

NFE technology significantly improves analyzer's noise floor

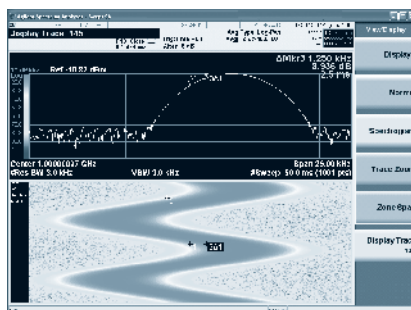

Spectrogram helps analyze time-variant signals

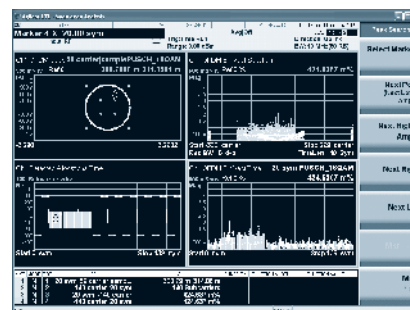

LTE modulation analysis on PXA with N9080A LTE measurement application

N9030A PXA High Performance Signal Analyzer

The PXA is the high-performance flagship instrument in the Agilent X-Series signal analyzer family. Designed for real-world signal analysis, Agilent's future-ready N9030A PXA signal analyzer is the evolutionary replacement for your current high-performance analyzer. By integrating backward compatibility features with state-of-the-art technologies, the PXA helps you sustain past achievements, enhance current designs and accelerate future innovations.

Future-Ready Signal Analyzer

The PXA offers flexibility to upgrade and enhance every major subsystem: Mechanical, electronic, firmware, and software.

- A mechanical assembly provides 7 expansion slots for future hardware enhancements
- A removable CPU motherboard enables CPU, memory and I/O upgrades
- GPIB and LXI/LAN ports for automated testing
- Firmware-based measurement applications add specialized or standard-compliant capabilities
- An open Windows® operating system lets you run software applications inside the analyzer

Drive Evolution in R&D

With the PXA's performance and flexibility, you'll be equipped to create state-of-the-art, original designs. Unravel complex signals with the PXA's broad set of measurement applications and demodulation capabilities, the Agilent 89600B vector signal analysis (VSA) software and the MATLAB from the MathWorks.

Facilitate Operations Evolution (ATE)

The automated test equipment (ATE) system you create today will be able to keep pace with future technology changes. Through its outstanding performance and speed, the PXA will help you reduce measurement uncertainties and improve yield.

Measure with Confidence

Innovative technology breakthroughs combined with traditional technical excellence enable the Agilent PXA to analyze signals over wider bandwidth, reduce measurement uncertainties, and reveal previously hidden signals. The PXA leads the way in high performance signal analysis.

- Super-wide IF technology provides almost twice the PSA's internal analysis bandwidth at an industry-leading 140 MHz, with up to 75 dB of spurious-free dynamic range
- Excellent third-order intermodulation (TOI) performance of +21 dBm helps achieve maximum third-order dynamic range
- Up to -88 dB 3GPP W-CDMA ACPR dynamic range
- -172 dBm (1 Hz RBW) effective displayed average noise level (DANL) at 2 GHz using NFE and optional preamp on
- Outstanding close-in phase noise performance of -129 dBc/Hz at 10 kHz offset for 1 GHz carrier
- ±0.19 dBm typical absolute amplitude accuracy up to 3.6 GHz

N9030A

Innovative NFE Technology

Agilent-exclusive noise floor extension (NFE) technology, a standard feature of the PXA, provides a dramatic improvement in the PXA signal analyzer's ability to accurately measure extremely low-level signals approaching the theoretical "kTB" noise floor.

NFE compensates for the noise contribution from active microcircuits in the RF and IF signal chains. The foundation of this technique is a comprehensive calibration procedure performed prior to shipment. With increased averaging, the analyzer's effective noise floor can be extended by up to 10 dB because 90% or more of the contributed noise power is predictable, which means it can be measured, calibrated and then eliminated during normal measurements.

Selection of Analysis Bandwidth Options

The N9030A PXA offers 10 MHz standard analysis bandwidth for analyzing digitally modulated signals. It also provides options for wider analysis bandwidth to meet your requirements in analyzing more complex signals with a higher data rate.

- *Option B1X*: 140 MHz analysis bandwidth
- *Option B40*: 40 MHz analysis bandwidth
- *Option B25*: 25 MHz analysis bandwidth

The wide analysis bandwidth options function with the industry-leading 89600B VSA software or the N9064A built-in VXA measurement application for vector analysis up to 140 MHz. Select one to best fit your application and achieve the highest performance-to-cost ratio. Upgrades from narrower to the wider analysis bandwidth capabilities are also available.

Achieve Greater Measurement Efficiency

Enhance your high-performance test systems with the power of the PXA. Compared to previous-generation analyzers, the PXA improves test speed and performance, leading to improved yields.

A variety of capabilities built into the PXA save time in manufacturing tests.

- Auto tune ensures easy signal setup
- Powerful and plentiful marker functions enable fast frequency, power, and relative measurements
- Limit lines simplify pass/fail testing
- Amplitude correction compensates for cables, antennas and other non-UUT devices in the signal path

One-Button Power Measurements

Like its predecessor, the PSA, the PXA also offers a standard suite of flexible one-button RF and microwave power measurements with radio format-based setups, referred to as PowerSuite. With PowerSuite, measurements that were once difficult and tedious to make are now executed with a single button press and provide easy-to-read results. The intuitive user interface of the PowerSuite is identical across the X-Series signal analyzers.

EMC

Use the PXA, with the optional EMC feature, to make pre-compliant measurements for conducted and radiated electromagnetic emissions. Option N9030A-EMC adds built-in CISPR 16-1-1 (2007) fully-compliant detectors and CISPR/MIL-STD EMI bandwidths to the PXA.

Furthermore, the X-Series EMC measurement application (N6141A) works with the PXA to deliver a feature-rich EMI pre-compliance test solution.

Spectrogram and Other Enhanced Displays (New!)

Option N9030A-EDP (enhanced display package) activates the following display functions in the swept SA measurements to diagnose your signals easier than ever:

- *Spectrogram* to visualize time-varying signals in the frequency domain
- *Trace zoom* to offer a close-up view at the frequency range under investigation
- *Zone span* to focus the details within a defined frequency window

Ensure Data Security

The PXA is equipped with a removable solid-state drive (SSD). In sensitive applications, the primary SSD can be designated as "classified" and swapped with another SSD that captures an image of the operating files but omits all user-stored information; the original SSD can be retained in a secure area. This simplifies data security if the instrument must be sent out for calibration, maintenance, or repair.

X-Series Measurement Applications

You can configure and reconfigure the PXA to fit evolving requirements. Installing optional X-Series measurement applications in the PXA transforms a high-performance general-purpose signal analyzer into a specialized signal tester. An ever-expanding library of the X-Series measurement applications is currently available for the PXA and includes:

- 89600B VSA software
- Analog demodulation
- *Bluetooth*
- Digital video (DVB-T/H/T2, Digital cable TV, ISDB-T, DTMB, CMMB)
- EMC pre-compliance measurements
- GSM/EDGE/EDGE-Evolution
- LTE (FDD and TDD)
- MATLAB
- Noise figure
- Phase noise
- Pulse
- Remote language compatibility
- SCPI language compatibility
- TD-SCDMA/HSDPA/HSUPA/8PSK
- VXA
- W-CDMA/HSDPA/HSUPA/HSPA+
- WiMAX™ 802.16 OFDMA

Identical across the X-Series, these applications use the same measurement algorithms, user interface, and remoter SCPI commands. Available transportable licensing allows you to mix and match the hardware that provides your required levels of performance for the specific measurement at hand.

Visit www.agilent.com/find/X-Series_apps for more details.

Delve Deep into Complex and Modulated Signals

Agilent's industry-leading 89600B VSA software and the embedded N9064A VXA measurement application provide comprehensive signal analysis and visualization in the time, frequency, modulation, and code domains. With support for over 70 signal standards and modulation formats, you'll be ready to analyze radar and communications signals, modulations from 2FSK to 1024QAM, and radio standards ranging from RFID to LTE.

Visit www.agilent.com/find/89600B for more details.

Explore Evolving Standards

When analyzing evolving signals and standards, built-in drivers make it easy to integrate the PXA into a MATLAB environment. MATLAB extends the functionality of Agilent signal and spectrum analyzers by providing tools to analyze data, execute custom demodulation schemes, filter signals, and automate measurements from signals acquired from these instruments.

Visit www.agilent.com/find/N6171A for more details.

Specifications

Frequency range

- Option 503: 3 Hz to 3.6 GHz (DC coupled), 10 MHz to 3.6 GHz (AC coupled)
- Option 508: 3 Hz to 8.4 GHz (DC coupled), 10 MHz to 8.4 GHz (AC coupled)
- Option 513: 3 Hz to 13.6 GHz (DC coupled), 10 MHz to 13.6 GHz (AC coupled)
- Option 526: 3 Hz to 26.5 GHz (DC coupled), 10 MHz to 26.5 GHz (DC coupled)

Analysis bandwidth

- Standard: 10 MHz
- Option B25: 25 MHz
- Option B40: 40 MHz
- Option B1X: 140 MHz

Phase noise

(20 to 30 °C, CF = 1 GHz)

Offset	Specification	Typical
10 Hz	—	-75 dBc/Hz (nominal)
100 Hz	-94 dBc/Hz	-100 dBc/Hz
1 kHz	-121 dBc/Hz	-125 dBc/Hz
10 kHz	-129 dBc/Hz	-132 dBc/Hz
100 kHz	-129 dBc/Hz	-132 dBc/Hz
1 MHz	-145 dBc/Hz	-146 dBc/Hz
10 MHz	-155 dBc/Hz	-158 dBc/Hz

Third-order intermodulation distortion (TOI)

(Two -16 dBm tones at input mixer with tone separation > 5 times IF prefilter bandwidth, 20 to 30 °C)

	Specification	Typical
10 to 150 MHz	+13 dBm	+16 dBm
150 to 600 MHz	+18 dBm	+21 dBm
0.6 to 1.1 GHz	+20 dBm	+22 dBm
1.1 to 3.6 GHz	+21 dBm	+23 dBm
3.5 to 8.4 GHz	+15 dBm	+22 dBm
8.3 to 13.6 GHz	+15 dBm	+23 dBm
13.5 to 17 GHz	+11 dBm	+17 dBm
17 to 26.5 GHz	+10 dBm	+17 dBm (nominal)

Displayed Average Noise Level (DANL)*

(Input terminated, sample or average detector, average type = log, 0 dB attenuation, IF gain = High, nominalized to 1 Hz RBW, 20 to 30 °C)

	Specification (without preamp)	Specification (preamp on)***
3 Hz to 9 kHz	-100 dBm (typical)	NA
9 to 100 kHz	-146 dBm	NA
100 to 200 kHz	-150 dBm	-157 dBm
200 to 500 kHz	-150 dBm	-160 dBm
0.5 to 1 MHz	-150 dBm	-164 dBm
1 to 10 MHz	-155 dBm	-164 dBm
10 MHz to 1.2 GHz	-155 dBm	-165 dBm
1.2 to 2.1 GHz	-153 dBm	-165 dBm
2.1 to 3.0 GHz	-152 dBm	-163 dBm
3.0 to 3.6 GHz	-151 dBm	-163 dBm
3.5 to 4.2 GHz	-147 dBm/-153 dBm**	-164 dBm
4.2 to 8.4 GHz	-150 dBm/-155 dBm**	-164 dBm
8.3 to 13.6 GHz	-149 dBm/-155 dBm**	-163 dBm
13.5 to 16.8 GHz	-145 dBm/-152 dBm**	-161 dBm
16.9 to 20 GHz	-143 dBm/-151 dBm**	-159 dBm
20 to 26.5 GHz	-137 dBm/-150 dBm**	-155 dBm

* With the NEF (noise floor extension) "Off"

** Requires Option LNP (low noise path) enabled. LNP improves DANL performance at higher frequency bands (beyond 3.6 GHz)

*** Requires preamp Option (P03, P08, P13, or P26). Preamp "On" supersedes "LNP enabled". LNP cannot operate simultaneously with preamp

Effective Displayed Average Noise Level (DANL) with NFE* "On"

(20 to 30 °C)

Frequency	Specification (without preamp)	Specification (preamp on)
Mid-Band 0 (1.8 GHz)	-163 dBm	-172 dBm
Mid-Band 1 (5.95 GHz)	-158 dBm	-172 dBm
Mid-Band 2 (10.95 GHz)	-157 dBm	-170 dBm
Mid-Band 3 (15.3 GHz)	-153 dBm	-166 dBm
Mid-Band 4 (21.75 GHz)	-145 dBm	-162 dBm

* NFE (noise floor extension) is included in all PXA units as a standard feature

Ordering Information

N9030A PXA signal analyzer options

N9030A-503 3 Hz to 3.6 GHz

N9030A-508 3 Hz to 8.4 GHz

N9030A-513 3 Hz to 13.6 GHz

N9030A-526 3 Hz to 26.5 GHz

N9030A-B25 analysis bandwidth, 25 MHz

N9030A-B40 analysis bandwidth, 40 MHz

N9030A-B1X analysis bandwidth, 140 MHz

N9030A-MPB microwave preselector bypass

N9030A-EA3 electronic attenuator, 3.6 GHz

N9030A-LNP low noise path

N9030A-P03 preamplifier, 3.6 GHz

N9030A-P08 preamplifier, 8.4 GHz

N9030A-P13 preamplifier, 13.6 GHz

N9030A-P26 preamplifier, 26.5 GHz

N9030A-SSD additional removable solid state drive

N9030A-CR3 connector rear, 2nd IF output

N9030A-CRP connector rear, arbitrary IF output

N9030A-YAV Y-axis video output

N9030A-ALV auxiliary log video output

N9030A-EMC basic EMC pre-compliance features

N9030A-EDP enhanced display package

N9030A-KB2 US 65 key USB keyboard

N9030A-EFM USB flash drive

N9030A-DVR USB DVD-ROM/CD-R/RW drive

N9030A-MLP minimum loss pad, 50 to 75 Ω

N9030A-1CP rack mount and handle kit

N9030A-1CM rack mount kit

N9030A-1CN front handle kit

N9030A-1CR rack slide kit

Warranty and services

Standard warrantee is 1 year

R-51B-001-3C 3-year return-to Agilent warranty and service

Calibrations

N9030A-UK6 commercial calibration certificate with test data

N9030A-1A7 ISO 17025 compliant calibration

N9030A-A6J ANSI Z540 compliant calibration

R-50C-011-3 inclusive calibration plan, 3 year coverage

R-50C-013-3 inclusive calibration plan and cal data, 3 year coverage

X-Series measurement applications

Refer to page 59 for details.

For more ordering information please refer to the PXA configuration guide, literature number 5990-3952EN.

Web Link

www.agilent.com/find/pxa

www.agilent.com/find/psa2pxa

N9020A

- 20 Hz to 3.6, 8.4, 13.6, or 26.5 GHz frequency range
- ± 0.23 dB absolute amplitude accuracy
- +16 dBm TOI, -163 dBm/Hz DANL, 78 dB W-CDMA ACLR dynamic range
- Optional 25 or 40 MHz analysis bandwidth
- Over 22 measurement applications and world-leading 89600B vector signal analysis software running inside MXA
- Programming language compatible with HP8566/68, 856x, ESA Series
- Up to 300% faster than other mid-performance class spectrum and signal analyzers

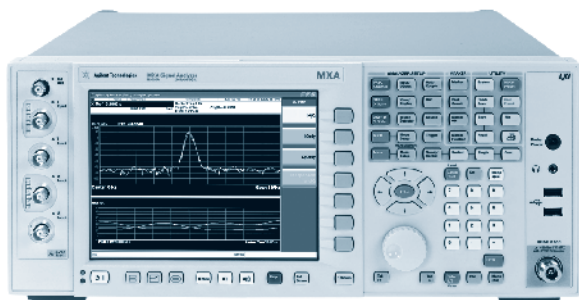

MXA signal analyzer with analog baseband IQ inputs

Eliminating the Compromise Between Speed and Performance

The MXA signal analyzer drives signal and spectrum analysis to the next level by offering the highest performance in a midrange analyzer and the industry's fastest signal and spectrum analysis.

Fastest Signal Analysis

Design validation and manufacturing floor engineers and managers agree that measurement speed is most critical in achieving their test goals. With this in mind, Agilent continues to compare the MXA's measurement speed against other signal and spectrum analyzers in the industry. The measurement results reveal that the MXA is 30 to 300% faster than other signal or spectrum analyzer regardless of the frequency range. Following are some key benchmark results¹.

- Local measurement and display update rate: 4 ms (250/s)
- Remote measurement and LAN transfer rate: 5 ms (200/s)
- Marker peak search: 1.5 ms
- Center frequency tune and transfer (RF): 20 ms
- Center frequency tune and transfer (μ W): 47 ms
- Measurement/mode switching: 39 ms

Highest Performance in a Midrange Signal Analyzer

Fast measurement speed doesn't mean compromising dynamic range. The MXA has the best-in-class dynamic range:

- +16 dBm third-order intercept (TOI)
- -162 dBm/Hz displayed average noise level (DANL)
- 78 dB W-CDMA ACLR dynamic range

With a 2 dB step mechanical attenuator or optional 1 dB step electrical attenuator and 160 resolution bandwidth settings (in 10% incremental steps), the MXA provides you with the best combination of speed and dynamic range.

¹ Nominal, sweep point = 101

One-Button Power Measurements: PowerSuite

MXA provides a comprehensive set of flexible, one-button RF and microwave power measurements, including:

- Channel power
- Occupied bandwidth (OBW)
- Adjacent channel power (ACP)
- Complementary cumulative distribution function (CCDF)
- Burst power
- Spurious emission
- Spectrum emission mask (SEM)
- TOI
- Harmonics

40 MHz Analysis Bandwidth

Activate optional 40 MHz analysis bandwidth to make measurements for wideband signals and other multi-carrier cellular applications:

- Enables modulation analysis for maximum LTE bandwidth, all profiles of mobile WiMAX, and WLAN via 89600B VSA software
- Provides 40 MHz bandwidth CCDF measurement or multi-carrier signals such as 4-carrier W-CDMA
- Provides 40 MHz bandwidth IQ waveform measurement, burst power measurement and QPSK EVM measurement
- Functions with N9064A VXA measurement application for vector analysis up to 40 MHz analysis bandwidth

Fully Calibrated Preamplifiers up to 26.5 GHz

Analyze low level signals on the only midrange analyzer to offer a choice of fully calibrated internal preamplifiers up to 26.5 GHz. You can select preamp frequency up to the maximum frequency of the instrument:

- Four different preamp frequencies are available: 100 kHz to 3.6, 8.4, 13.6 or 26.5 GHz
- Gain +20 dB from 100 kHz to 3.6 GHz and +35 dB from 3.6 to 26.5 GHz

Time Gating

Analyze time varying signals such as WiMAX, pulsed RF, time division multiple access (TDMA), and interleaved and burst-modulated signals with time gating capability. The Agilent MXA offers three types of time gating – gated LO (or gated sweep), gated video, and gated FFT:

- Gated LO offers the fastest time gating measurement for a full span of frequency
- Gated FFT offers the fastest time gating measurement within the span of analysis bandwidth (10 MHz standard, 25 MHz, 40 MHz optional)
- Gated video offers the backward compatibility with Agilent ESA, 856x and 859x Series spectrum analyzers

List Sweep

Save measurement time by programming the MXA analyzer for fast power measurements using the list sweep feature. Remotely extract amplitude values at known frequencies by making a list of single-point measurements in advance. The MXA can also run through the measurements without requiring you to reset the analyzer for each iteration of a measurement cycle. You can:

- Make multiple zero span measurements at multiple frequencies
- Choose different resolution bandwidths, video bandwidths, detector types, and sweep times at different sweep points
- Obtain peak and average power measurement result

89600B Vector Signal Analysis (VSA) Software Runs in the Instrument

The MXA is the first signal analyzer that has the world's best-selling VSA software running in it. It offers a convenient access to analysis of complex, time-varying signals using the advanced modulation analysis algorithms to help you develop, troubleshoot, and verify the physical layer performance of your radio system. Easily navigate the 89600B VSA user interface using a keyboard and mouse. A 14-day trial version of the 89600B VSA software is included in every MXA signal analyzer. Evaluate the software for free and access the in-depth help file to learn more about the software. For more information, refer to the section on the VSA or visit www.agilent.com/find/vsa.

MATLAB

MXA officially supports MATLAB. You can run MATLAB and 89600B VSA, the two most popular software products for system designers in the wireless communication industry, in a single instrument. MATLAB support allows you to create custom measurement programs for the MXA. In addition, Agilent provides plenty of sample programs – visit www.agilent.com/find/matlab_sa for drivers, sample programs, and more information.

Specifications

Frequency range

- Option 503: 20 Hz to 3.6 GHz, (DC coupled), 10 MHz to 3.6 GHz (AC coupled)
- Option 508: 20 Hz to 8.4 GHz (DC coupled), 10 MHz to 8.4 GHz (AC coupled)
- Option 513: 20 Hz to 13.6 GHz (DC coupled), 10 MHz to 13.6 GHz (AC coupled)
- Option 526: 20 Hz to 26.5 GHz (DC coupled), 10 MHz to 26.5 GHz (AC coupled)

Analysis bandwidth

- Standard: 10 MHz
- Option B25: 25 MHz
- Option B40: 40 MHz

Phase noise

(20 to 30 °C, CF = 1 GHz)

Offset	Specification	Typical
100 Hz	-84 dBc/Hz	-88 dBc/Hz
1 kHz	—	-101 dBc/Hz nominal
10 kHz	-103 dBc/Hz	-106 dBc/Hz
100 kHz	-115 dBc/Hz	-117 dBc/Hz
1 MHz	-135 dBc/Hz	-137 dBc/Hz
10 MHz	—	-148 dBc/Hz nominal

Third-order intermodulation distortion (TOI)

(Two -30 dBm tones at input mixer with tone separation > 15 kHz, 20 to 30 °C)

	Specification	Typical
10 to 100 MHz	+12 dBm	+17 dBm
100 to 400 MHz	+15 dBm	+20 dBm
400 MHz to 1.7 GHz	+16 dBm	+20 dBm
1.7 to 3.6 GHz	+16 dBm	+19 dBm
3.6 to 8.4 GHz	+15 dBm	+18 dBm
8.4 to 13.6 GHz	+15 dBm	+18 dBm
13.6 to 26.5 GHz	+10 dBm	+14 dBm

Displayed average noise level (DANL)

(Input terminated, sample or average detector, average type = log, 20 to 30 °C, zero span, swept, nominalized to 1 Hz RBW, 0 dB attenuation)

	Specification (without preamp)	Specification (preamp on)*
9 kHz to 1 MHz	-130 dBm typical	-149 dBm typical
1 to 10 MHz	-150 dBm	-161 dBm
10 MHz to 2.1 GHz	-151 dBm	-163 dBm
2.1 to 3.6 GHz	-149 dBm	-162 dBm
3.6 to 8.4 GHz	-149 dBm	-162 dBm
8.4 to 13.6 GHz	-148 dBm	-162 dBm
13.6 to 17.1 GHz	-144 dBm	-159 dBm
17.1 to 20.0 GHz	-143 dBm	-157 dBm
20.0 to 26.5 GHz	-136 dBm	-152 dBm

* Requires preamp Option P03, P08, P13, or P26

Ordering Information

For further information, refer to MXA signal analyzer configuration guide (5989-4943EN)

Hardware

N9020A MXA signal analyzer

- N9020A-503** frequency range, 20 Hz to 3.6 GHz
- N9020A-508** frequency range, 20 Hz to 8.4 GHz
- N9020A-513** frequency range, 20 Hz to 13.6 GHz
- N9020A-526** frequency range, 20 Hz to 26.5 GHz
- N9020A-B25** analysis bandwidth, 25 MHz
- N9010A-B40** analysis bandwidth, 40 MHz
- N9020A-PFR** precision frequency reference (variable)
- N9020A-EA3** electronic attenuator, 3.6 GHz
- N9020A-P03** preamplifier, 3.6 GHz
- N9020A-P08** preamplifier, 8.4 GHz
- N9020A-P13** preamplifier, 13.6 GHz
- N9020A-P26** preamplifier, 26.5 GHz
- N9020A-ESC** external source control
- N9020A-CR3** wideband IF output
- N9020A-CRP** programmable IF output

Accessories

- N9020A-MSE** mouse
- N9020A-KYB** keyboard
- N9020A-EFM** USB flash drive, 512 MB
- N9020A-DVR** USB DVD-ROM/CD-R/RW drive
- N9020A-MLP** minimum loss pad, 50 to 75 ohm
- N9020A-PRC** portable configuration
- N9020AK-CVR** front panel cover, additional
- N9020A-1CP** rack mount and handle kit
- N9020A-1CM** rack mount kit
- N9020A-1CN** front handle kit
- N9020A-1CR** rack slide kit
- N9020A-HTC** hard transit case

Applications

See page 59 X-Series measurement application section

Documentation

- N9020A-1A7** ISO17025 compliant calibration
- N9020A-A6J** ANSI Z540 compliant calibration
- N9020A-AB1** getting started Korean
- N9020A-ABJ** getting started Japanese
- N9020A-ABD** getting started German
- N9020A-ABF** getting started French
- N9020A-AKT** getting started Russian

Warranty and service

Standard warranty is one year

R-51B-001-3C 1 year return-to-Agilent warranty extended to 3 years

Calibration (Options not available in all countries)

R-50C-011-3 inclusive calibration plan, 3 year coverage

R-50C-013-3 inclusive calibration plan and cal data, 3 year coverage

Web Link

www.agilent.com/find/mxa

N9010A

- 9 kHz to 3.6, 7.0, 13.6, or 26.5 GHz frequency range
- ± 0.27 dB absolute amplitude accuracy
- +13 dBm TOI, -161 dBm/Hz DANL
- Optional 25 or 40 MHz analysis bandwidth
- Over 22 measurement applications and world-leading 89600B vector signal analysis software running inside EXA
- Programming language compatible with HP8566/68, 856x, ESA Series
- Up to 300% faster than other economy class spectrum and signal analyzers

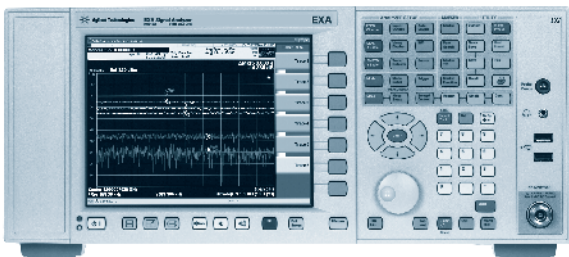

The Agilent EXA economy signal analyzer offers unprecedented speed, accuracy, and application coverage for an economy class instrument

Make Every Millisecond Count

From product design to the production line, every device demands decisions that require tradeoffs in your goals – product specifications, throughput and yield. Whether you're focused on time-to-market, time-to-volume or cost of test, your choice of economy-class signal analyzer should help you save both time and money. The Agilent EXA signal analyzer makes this possible by eliminating the compromise between speed and price. In addition, the outstanding accuracy of the EXA lets you accelerate the transition from design into manufacturing and helps reduce your overall cost of test. When you need speed without compromise, the Agilent EXA signal analyzer lets you make every millisecond count.

Enhance Throughput with Excellent Speed

- Local measurement and display update rate: 11 ms (90/s), 4 ms (250/s) with Option PC2
- Remote measurement and LAN transfer rate: 6 ms (167/s), 5 ms (200/s) with Option PC2
- Marker peak search: 5 ms, 1.5 ms with Option PC2
- Center frequency tune and transfer (RF): 22 ms, 20 ms with Option PC2
- Center frequency tune and transfer (μ W): 49 ms, 47 ms with Option PC2
- Measurement/mode switching: 75 ms nominal, 39 ms with Option PC2

Highest Performance in an Economy Class Signal Analyzer

Fast measurement speed doesn't mean compromising dynamic range. With optional 2 dB step mechanical attenuator or 1 dB step electrical attenuator and 160 resolution bandwidth settings (in 10% incremental steps), the EXA provides you with the best combination of speed and dynamic range. EXA's electronic attenuator is able to withstand millions of switches – making it ideal for high speed manufacturing.

89600B Vector Signal Analysis (VSA) Software Runs in the Instrument

The EXA has the world's best-selling VSA software running in it. It offers a convenient access to analysis of complex, time-varying signals using the advanced modulation analysis algorithms to help you develop, troubleshoot, and verify the physical layer performance of your radio system. Easily navigate the 89600B VSA user interface using a keyboard and mouse. A 14-day trial version of the 89600B VSA software is included in every EXA signal analyzer. Evaluate the software for free and access the in-depth help file to learn more about the software. See page 61 for further information of VSA software.

Simplify Manual Testing with An Advanced – Yet Familiar – User Interface

- Save time and effort with capabilities such as fast mode switching, 4-ms peak search, six independent traces, 12 markers, band power markers and a peak table
- Transfer test results quickly and easily via built-in 100BASE-T LAN and USB 2.0 ports
- Ensure easy operation and connectivity through the familiarity and openness of Windows

Reach New Insights Faster with Versatile Measurement Capabilities

- Confidently pinpoint signal quality issues with accurate measurements
- Perform advanced troubleshooting with capabilities formerly found only on high-end signal analyzers
- Utilize the broadest application coverage available in an economy-class signal analyzer including the 89600B vector signal analysis software, phase noise, analog demodulation and noise figure
- Enhance the EXA with easy updates as test needs and budgets evolve
- Address the latest standards – W-CDMA/HSDPA/HSUPA, GSM/EDGE, cdma2000, LTE, Mobile WiMAX – with specific measurement applications and a suite of fast, one-button RF power measurements
- Run applications such as MATLAB inside the EXA

Enhanced Standard Features

Auto tune

At the press of a button, the analyzers center frequency adjusts to the strongest signal in the tunable span of the analyzer, changes the span to three times the occupied bandwidth of the signal, sets the resolution and video bandwidth, optimizes the reference level, performs a peak search, sets a marker on the peak, and displays the measurement result. This is a patented Agilent exclusive feature.

Advanced markers and traces

Determine the precise value at each trace point quickly with the advance marker capability. Twelve independent markers, based on frequency or position, can be set as a reference for any other marker. Band marker enables easy setup for power ratio measurements and results can be viewed on the marker table. Display up to six traces, in the same display window, each with independent detectors.

Built in help

Instead of searching through hundreds of pages in a manual, just press Help key to evoke comprehensive help system inside the EXA – any key, any menu, anytime. This includes handy SCPI programming commands.

Time gating

Analyze time varying signals such as WiMAX, pulsed RF, time division multiple access (TDMA), interleaved and burst-modulated with time gating capability. The Agilent EXA offers three types of Time Gating: Gated LO (or Gated sweep), Gated Video and Gated FFT.

- Gated LO offers the fastest Time Gating measurement for full span of frequency
- Gated FFT offers the fastest Time Gating measurement within the span of analysis bandwidth (10 MHz standard, 25 MHz, 40 MHz optional)
- Gated Video offers the backward compatibility with Agilent ESA, 856x and 859x Series spectrum analyzers

List Sweep

Save measurement time by programming the EXA analyzer for fast power measurements using the list sweep feature. Remotely extract amplitude values at known frequencies by making a list of single-point measurements in advance. The EXA can run through the measurements without requiring you to reset the analyzer for any iteration of a measurement cycle.

MATLAB

Agilent supports MATLAB driver officially allowing you to run MATLAB and 89600B VSA, which are the two most popular software products for system designers in the wireless communication industry. Agilent also provides sample programs at: www.agilent.com/find/matlab_sa

Advanced Measurement Applications

Please see the measurement application section for standards based, one-button measurement applications such as: phase noise, noise figure, analog demodulation, WiMAX, GSM/Edge, cdma2000, and W-CDMA.

Specifications

Frequency range

- Option 503: 9 kHz to 3.6 GHz (DC coupled), 10 MHz to 3.6 GHz (AC coupled)
- Option 507: 9 kHz to 7.0 GHz (DC coupled), 10 MHz to 7.0 GHz (AC coupled)
- Option 513: 9 kHz to 13.6 GHz (DC coupled), 10 MHz to 13.6 GHz (AC coupled)
- Option 526: 9 kHz to 26.5 GHz (DC coupled), 10 MHz to 26.5 GHz (AC coupled)

Analysis bandwidth

- Standard: 10 MHz
- Option B25: 25 MHz
- Option B40: 40 MHz

Phase noise

(20 to 30 °C, CF = 1 GHz)

Offset	Specification	Typical
100 Hz	-84 dBc/Hz	-88 dBc/Hz
1 kHz	—	-98 dBc/Hz nominal
10 kHz	-99 dBc/Hz	-102 dBc/Hz
100 kHz	-112 dBc/Hz	-114 dBc/Hz
1 MHz	-132 dBc/Hz	-135 dBc/Hz
10 MHz	—	-143 dBc/Hz nominal

Third-order intermodulation distortion (TOI)

(Two -30 dBm tones at input mixer with tone separation > 15 kHz, 20 to 30 °C)

	Specification	Typical
10 to 100 MHz	—	—
100 to 400 MHz	+10 dBm	+14 dBm
400 MHz to 1.7 GHz	+11 dBm	+15 dBm
1.7 to 3.6 GHz	+13 dBm	+17 dBm
3.6 to 5.1 GHz	+11 dBm	+17 dBm
5.1 to 7.0 GHz	+13 dBm	+17 dBm
7.0 to 13.6 GHz	+11 dBm	+15 dBm
13.6 to 26.5 GHz	+9 dBm	+14 dBm

Displayed average noise level (DANL)

(Input terminated, sample or average detector, average type = log, 20 to 30 °C, zero span, swept, nominalized to 1 Hz RBW, 0 dB attenuation)

	Specification (without preamp)	Specification (preamp on)*
9 kHz – 1 MHz	—	—
1 to 10 MHz	-147 dBm	—
10 MHz to 2.1 GHz	-148 dBm	-161 dBm
2.1 to 3.6 GHz	-147 dBm	-160 dBm
3.6 to 7.0 GHz	-147 dBm	-160 dBm
7.0 to 13.6 GHz	-143 dBm	—
13.6 to 17.1 GHz	-137 dBm	—
17.1 to 20.0 GHz	-137 dBm	—
20.0 to 26.5 GHz	-134 dBm	—

* Requires preamp Option P03 or P07

Ordering Information

Hardware

N9010A EXA signal analyzer

- N9010A-503** frequency range, 9 kHz to 3.6 GHz
- N9010A-507** frequency range, 9 kHz to 7.0 GHz
- N9010A-513** frequency range, 9 kHz to 13.6 GHz
- N9010A-526** frequency range, 9 kHz to 26.5 GHz
- N9010A-B25** analysis bandwidth, 25 MHz
- N9010A-B40** analysis bandwidth, 40 MHz
- N9010A-PFR** precision frequency reference (variable)
- N9010A-EA3** electronic attenuator, 3.6 GHz
- N9010A-P03** preamplifier, 3.6 GHz
- N9010A-P07** preamplifier, 7.0 GHz
- N9010A-ESC** external source control
- N9010A-CR3** wideband IF output
- N9010A-CRP** programmable IF output

Accessories

- N9010A-1CP** rackmount and handle kit
- N9010A-1CM** rackmount kit
- N9010A-1CN** front handle kit
- N9010A-1CR** rack slide kit
- N9010A-EFM** USB Flash drive, 4 GB
- N9010A-DVR** DVD-ROM/CD-ROM/RW drive
- N9010A-KYB** Keyboard, USB
- N9010A-KB2** US 65 key USB keyboard
- N9010A-MLP** minimum loss pad, 50 to 75 ohm
- N9010A-BAG** accessory pouch

Measurement applications

Refer to the X-Series measurement application section or visit www.agilent.com/find/xseries_applications

Warranty and service

Standard warranty is one year

R-51B-001-3C 1 year return-to-Agilent warranty extended to 3 years

Calibration (Options not available in all countries)

R-50C-011-3 inclusive calibration plan, 3 year coverage

R-50C-013-3 inclusive calibration plan and cal data, 3 year coverage

Web Link

www.agilent.com/find/exa

N9000A

- 9 kHz to 3.0 or 7.5 GHz frequency range
- Optional tracking generator
- ± 0.5 dB absolute amplitude accuracy
- +13 dBm TOI, -161 dBm/Hz DANL
- Over 22 measurement applications and world-leading 89600B vector signal analysis software running inside CXA
- Programming language compatible with ESA Series
- Up to 300% faster than other low-cost class spectrum and signal analyzers

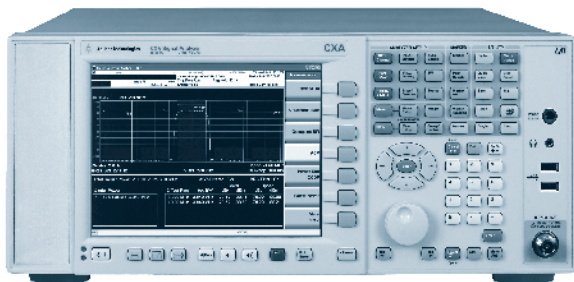

The Agilent CXA signal analyzer offers low cost entry into the Agilent X-Series signal analyzer family

Expect More

With a flexible, dependable signal analyzer, you're ready for your next measurement challenge. The Agilent CXA signal analyzer is a versatile, low-cost tool for essential signal characterization. It helps you accelerate product testing and development on multiple levels: cost reduction, throughput, design enhancement and more. The CXA also enhances education in RF technology and wireless communication. Get essential capability along with X-Series expandability in the CXA – and expect more.

Expect More in Manufacturing Test

The CXA is well-suited to manual or automated testing of RF components such as amplifiers and filters, as well as electronic products such as cordless phones, wireless LAN routers, and wireless paging systems. Whether you are pursuing cost-reduction initiatives or greater throughput, the flexible, dependable CXA can enhance your manufacturing process.

Excellent uptime

- Local measurement and display update rate: 6 ms
- Remote measurement and LAN transfer rate: 11 ms
- Marker peak search: 2 ms
- Center frequency tune and transfer: 51 ms

Tracking generator

The CXA offers an optional tracking generator with a frequency range up to 3 GHz (for N9000A-503) and 6 GHz (for N9000A-507).

List sweep

Save measurement time by programming the CXA analyzer for fast power measurements using the list sweep feature. Remotely extract amplitude values at known frequencies by making a list of single point measurements in advance. The CXA can run through the measurements without requiring you to reset the analyzer for any iteration of a measurement cycle.

One-button power measurements: PowerSuite

PowerSuite, a subset of the spectrum analyzer capabilities, provides a comprehensive set of flexible, one-button RF and microwave power measurements. Wireless standards-based setups include: 2G/3G, WLAN, Bluetooth, UWB, and S-DMB. Use the more than 75 quick setups or use custom settings for specific power measurements that are not already preconfigured.

- Adjacent channel power (ACP)
- Channel power
- Occupied bandwidth (OBW)
- Spectrum emission mask (SEM)
- Complementary cumulative distribution function (CCDF)
- Burst power
- Spurious emissions

Modern connectivity

Take advantage of modern connectivity as well as legacy connectivity and backward compatibility:

- Connect your CXA to a LAN and control the MXA remotely – view signals and acquire and analyze waveform data from anywhere in the world using either the embedded web server or Windows remote desktop software
- Connect the CXA to the LAN to share files and print to networked computers
- Use IVI-COM drivers for Agilent VEE
- Save time by reusing test code with the CXA's backward code compatibility to the ESA and PSA as well as code written for other Agilent X-Series signal analyzers
- The CXA is an LXI Class C compliant signal analyzer that can help you and your team open new possibilities in testing
- Chose the best connection for your requirements:
 - USB 2.0 – six type A, one type B
 - LAN – 100 based-T
 - GPIB

Open Windows XP professional operating system

- In manual testing applications, learning is fast with a user interface based on Microsoft Windows XP and the Agilent X-Series
- Manage files easily and quickly using Windows Explorer

Built-in help

Instead of storing and scouring through hundreds of pages of manuals, just press the Help key to evoke a comprehensive context-sensitive help system inside the CXA – any key, any menu, anytime. Use keys on the CXA's front panel to view the rich manual content which also includes handy SCPI programming commands.

Expect More in Product Development

The CXA helps you accelerate product development and design enhancement while staying within your equipment budget. Whether you're rapidly updating a next-generation product or revising an existing design, the CXA can help you perform signal characterization for testing, verification and troubleshooting. The CXA's built-in capabilities let you perform essential measurements of frequency, level, spurious and distortion without overspending your budget. For greater insight, you can enhance the analyzer's capability with X-Series measurement applications.

Rich measurement applications

All X-Series signal analyzers share a common library of more than 20 advanced measurement applications, which cover:

- General purpose: analog demod, phase noise, pulse measurement, etc.
- Cellular applications: TD-SCDMA, W-CDMA, GSM/EDGE, etc.
- Wireless networking: Bluetooth, WiMAX, etc.
- Digital video: DVB-T/H, ISDB-T, DTBM, CMMB, etc.

See page 59 for further information about X-Series advanced measurement application software.

89600B vector signal analysis (VSA) software runs in the instrument

Like other X-Series platforms, the CXA has the world's best-selling VSA software running in it. It offers convenient access to analysis of complex, time-varying signals using the advanced modulation analysis algorithms to help you develop, troubleshoot, and verify the physical layer performance of your radio system. Easily navigate the 89600B VSA user interface using a keyboard and mouse. A 14-day trial version of the 89600B VSA software is included in every CXA signal analyzer. Evaluate the software for free and access the in-depth help file to learn more about the software. See page 59 for further information of VSA software.

W9064A VXA vector signal analyzer measurement application

The VXA measurement application combines advanced measurement algorithms from Agilent's industry-leading 89600B VSA software with SCPI programming and the familiar X-Series signal analyzer front-panel user interface. The result: measurements you can trust to thoroughly test your design, plus familiar tools to quickly automate the tests you choose.

Go to www.agilent.com/find/w9064a for more information.

EMC precompliance test

With the EMC measurement application, CXA enables the user to perform pre-compliance conducted and radiated emissions tests to both commercial and MIL-STD requirements. Basic and advanced features are provided with options for users based on the requirements.

Basic pre-compliance EMI features (Option N9000A-EMC):

- Fully CISPR 16-1-1 (2007) compliant detectors
- CISPR band presets to 18 GHz
- Measure at marker with three detectors
- Tune and Listen for signal discrimination
- CISPR and MIL-STD bandwidths
- Regulatory agency limits available

Advanced EMC measurement application which delivers a feature-rich pre-compliance test solution (X-Series application W6141A):

- Log and linear display
- Signal list
- Scan table
- Simultaneous detectors
- Delta to limit
- Strip chart
- Step and swept scans

For more information, visit www.agilent.com/find/w6141a, or read N6141A & W6141A EMC X-Series advanced measurement application, p/n 5990-6035EN.

MATLAB

CXA officially supports MATLAB for general purpose data analysis, visualization, and measurement automation. You can run MATLAB and 89600B VSA, the two most popular software products for system designers in the wireless communication industry, in a single instrument. MATLAB support allows you to create custom measurement programs for the CXA. In addition, Agilent provides plenty of sample programs – visit www.agilent.com/find/matlab_sa for drivers, sample programs, and more information.

Auto tune

At the press of a button, the analyzer's center frequency adjusts to the strongest signal in the tunable span of the analyzer, changes the span to three times the occupied bandwidth of the signal, sets the resolution and video bandwidth, optimizes the reference level, performs a peak search, sets a marker on the peak, and displays the measurement result. This is a patented Agilent exclusive feature.

Time gating

Analyze time varying signals such as WiMAX, pulsed RF, time division multiple access (TDMA), interleaved and burst-modulated signals with time gating capability. The Agilent CXA offers three types of time gating – gated LO (or gated sweep), gated video, and gated FFT:

- Gated LO offers the fastest time gating measurement for a full span of frequency
- Gated FFT offers the fastest time gating measurement within the span of analysis bandwidth (10 MHz standard, 25 MHz optional)
- Gated video offers the backward compatibility with Agilent ESA, 856x and 859x Series spectrum analyzers

Advanced markers and traces

Determine the precise value at each trace point quickly with CXA's advanced marker capability. Twelve markers, either frequency or position based, are available. Any marker can be a reference for other markers. Band marker enables easy setup for power ratio measurements such as adjacent channel power (ACP) and noise power ratio (NPR). You can view all readings of the markers on the marker table. You can also display up to six traces, such as a carrier plus up to five harmonics, in the same display window. In addition, you can choose a detectors (Normal, Average/RMS, Positive peak, Negative peak) to each trace independently.

Expect more in RF education

The CXA is also an excellent tool for the teaching of RF signal analysis, from basic RF circuit characterization to advanced signal analysis.

- 89600B VSA software can help students develop practical skills and deeper insights into RF technology through the fundamentals of signal analysis
- The familiar and intuitive Windows-based X-Series interface helps students focus on measurement theory rather than instrument operation
- It's also easy to integrate the CXA into popular analysis environments such as MATLAB for data analysis, visualization and publication, as the CXA is an open Windows instrument

Specifications**Frequency range**

- Option 503: 9 kHz to 3.0 GHz
- Option 507: 9 kHz to 7.5 GHz

Analysis bandwidth

- Standard: 10 MHz
- Option B25: 25 MHz

Phase noise

(20 to 30 °C, CF = 1 GHz)

Offset	Specification	Typical
1 kHz	-94 dBc/Hz	-98 dBc/Hz nominal
10 kHz	-99 dBc/Hz	-102 dBc/Hz
100 kHz	-102 dBc/Hz	-104 dBc/Hz
1 MHz	-120 dBc/Hz	-121 dBc/Hz
10 MHz	—	-143 dBc/Hz nominal

Third-order intermodulation distortion (TOI)

Note: two -20 dBm tones at input mixer with tone separation > 15 kHz, 20 to 30 °C.

	Specification	Typical
10 to 400 MHz	+10 dBm	+14 dBm
400 MHz to 3.0 GHz	+13 dBm	+17 dBm
3.0 to 7.5 GHz	+13 dBm	+15 dBm

N9000A

Displayed average noise level (DANL)

(Input terminated, sample or average detector, average type = log, 20 to 30 °C, zero span, swept, nominalized to 1 Hz RBW, 0 dB attenuation)

	Specification (without preamp)	Specification (preamp on)
1 to 10 MHz	-130 dBm	-149 dBm
10 MHz to 1.5 GHz	-148 dBm	-161 dBm
1.5 to 2.2 GHz	-144 dBm	-160 dBm
2.2 to 3.0 GHz	-140 dBm	-158 dBm
3.0 to 4.5 GHz	-137 dBm	-155 dBm
4.5 to 6.0 GHz	-133 dBm	-152 dBm
6.0 to 7.5 GHz	-128 dBm	-148 dBm

Ordering Information

CXA signal analyzer data sheet (5990-4327EN)

CXA signal analyzer configuration guide (5990-4341EN)

Hardware

N9000A CXA signal analyzer

N9000A-503 frequency range, 9 kHz to 3.0 GHz

N9000A-507 frequency range, 9 kHz to 7.5 GHz

N9000A-B25 analysis bandwidth, 25 MHz

N9000A-PFR precision frequency reference

N9000A-P03 preamplifier, 3.0 GHz

N9000A-P07 preamplifier, 7.5 GHz

N9000A-ESC external source control

N9000A-FSA fine resolution step attenuator

N9000A-TG3 3 GHz tracking generator

N9000A-TG6 6 GHz tracking generator

Optional features

N9000A-EMC basic precompliance EMI features

Accessories

N9000A-1CP rack mount and handle kit

N9000A-1CM rack mount kit

N9000A-1CN front handle kit

N9000A-1CR rack slide kit

N9000A-PRC portable configuration

N9000A-MSE mouse

N9000A-KYB keypad

N9000AK-KB2 US 65 key USB keyboard

N9000A-EFM USB flash drive, 4 GB

N9000A-SWM CXA instrument software on USB media

N9000A-DVR USB DVD-ROM/CD-R/RW drive

N9000A-MLP minimum loss pad, 50 to 75 ohm

N9000A-HTC hard transit case

N9000A-BAG accessory pouch

Measurement applications

See page 59, X-series measurement application section, or visit

www.agilent.com/find/xseries_applications

Documentation

N9000A-1A7 ISO17025 compliant calibration

N9000A-A6J ANSI Z540 compliant calibration

N9000A-AB1 getting started Korean

N9000A-ABJ getting started Japanese

N9000A-ABD getting started German

N9000A-ABF getting started French

N9000A-AKT getting started Russian

Warranty and service

Standard warranty is one year

R-51B-001-3C 1 year return-to-Agilent warranty extended to 3 years

Calibration (Options not available in all countries)

R-50C-011-3 inclusive calibration plan, 3 year coverage

R-50C-013-3 inclusive calibration plan and cal data, 3 year coverage

Web Link

www.agilent.com/find/cxa

N9000A
N9010A
N9020A
N9030A

- Make RF measurements for systems and components
- One-button measurements available with pass/fail limit per most standards
- Hardkey/softkey manual user interface and SCPI remote user interface
- Built-in context-sensitive help
- Runs inside X-Series signal analyzers
- Transportable license between PXA, MXA and EXA
- License key upgradable

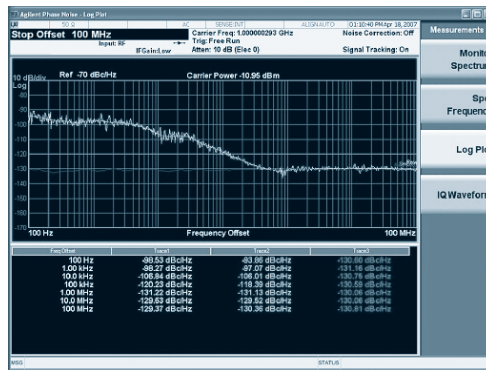
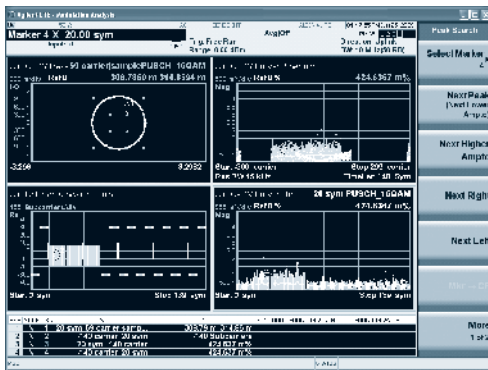
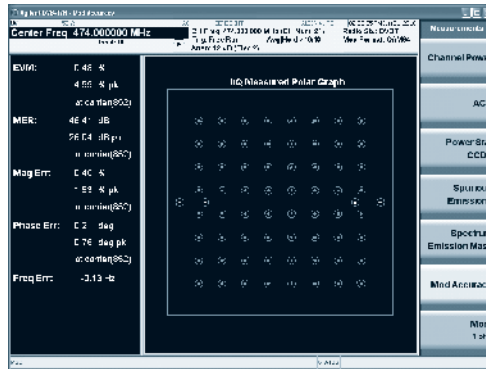
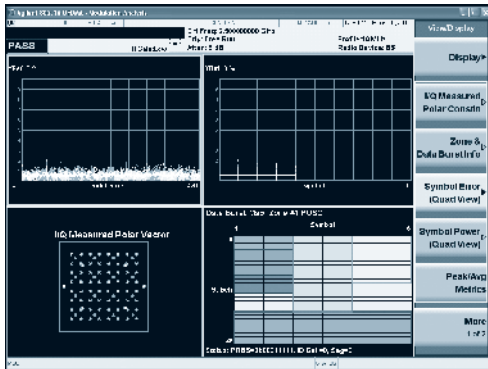

3

A shared library of more than 22 advanced measurement applications for use in the X-Series signal analyzers increase the capability and functionality of the analyzers to speed your time to insight. These software measurement applications provide essential measurements for specific tasks in general purpose, cellular communications, wireless connectivity and digital video applications.

The measurement application software is identical across all of the X-Series analyzers. The only difference is the level of performance achieved by the instrument hardware selected. Choose the level of performance necessary for your application and have full assurance that the calculations and algorithms are the same across your X-Series signal analyzers, from the development lab into manufacturing.

General Purpose

The X-Series signal analyzers offer a variety of general purpose measurement applications for use in the development and manufacturing of RF and microwave transceivers and the components that comprise them. The general purpose measurement applications cover a full range of solutions from phase noise measurements for oscillator tests to noise figure test of amplifiers to digital demodulation on standards-based or proprietary formats using the flexible digital modulation measurement application supporting more than 30 demodulators. X-Series signal analyzers support MATLAB, allowing you to create custom measurement programs for analyzing evolving signals and standards with your X-Series analyzers.

Measurement application	Model number	N9030A PXA High performance	N9020A MXA Mid performance	N9010A EXA Economy class	N9000A CXA Low cost
Analog demodulation	N9063A W9063A	•	•	•	•
Phase noise	N9068A W9068A	•	•	•	•
Noise figure	N9069A W9069A	•	•	•	•
MATLAB	N6171A	•	•	•	•
Pulse	N9051A	•	•	•	•
Remote language compatibility for 856x/E/C, 8566/68	N9061A	•	•	•	•
SCPI command language compatibility	N9062A	•	•	•	•
VXA vector signal and WLAN modulation analysis	N9064A W9064A	•	•	•	•
EMC precompliance	N6141A W6141A	•	•	•	•

N9000A
N9010A
N9020A
N9030A

Cellular Communication

The X-Series measurement applications can transform the X-Series signal analyzers into standards-based transmitter testers, with cellular communication measurement applications covering a full range of technologies – from existing 2G, 3G systems to evolving 3.5G, 4G communications systems. The measurement applications closely follow the 3GPP and 3GPP2 standards, allowing you to stay ahead of your design and manufacturing challenges.

Measurement application	Model number	N9030A PXA High performance	N9020A MXA Mid performance	N9010A EXA Economy class	N9000A CXA Low cost
LTE-FDD	N9080A	•	•	•	
LTE-TDD	N9082A	•	•	•	
W-CDMA/HSPA/HSPA+	N9073A W9073A	•	•	•	• ¹
TD-SCDMA	N9079A W9079A	•	•	•	•
GSM/EDGE/EDGE Evolution	N9071A W9071A	•	•	•	• ²
Cdma2000	N9072A W9072A	• ³	•	•	• ³
1xEV-DO	N9076A W9076A	• ³	•	•	• ³
iDEN/WiDEN/MotoTalk	N6149A		•	•	

¹ W-CDMA and HSPA only. HSPA+ will be available mid-2011
² GSM and EDGE only. EDGE evolution will be available mid-2011
³ Available mid-2011

Wireless Connectivity

The wireless connectivity advanced X-Series measurement applications cover a full range of technologies – from *Bluetooth* thru 802.11 WLAN and 802.16e OFDMA mobile WiMAX. As technology advances, the X-Series advanced measurement applications evolve to enable you to continue tackling increasingly complex design and manufacturing test challenges.

Measurement application	Model number	N9030A PXA High performance	N9020A MXA Mid performance	N9010A EXA Economy class	N9000A CXA Low cost
<i>Bluetooth</i>	N9081A W9081A	•	•	•	•
802.11 WLAN ¹	N9077A		•	•	
Fixed WiMAX ¹	N9074A		•	•	
802.16e OFDMA mobile WiMAX	N9075A W9075A	•	•	•	•

¹ These are single acquisition combined measurement (SACM) applications that are optimized for manufacturing

Digital Video

The X-Series measurement applications transform the X-Series signal analyzers, which offer world-class accuracy, flexibility and standard-compliant measurement applications for digital video technologies into standard-based testers for modulators, transmitters, amplifiers, tuners and gap-fillers/repeaters. The measurement applications cover a full range of digital video technologies – from DVB-T/H to DTMB (CTTB), CMMB and ISDB-T.

Measurement application	Model number	N9030A PXA High performance	N9020A MXA Mid performance	N9010A EXA Economy class	N9000A CXA Low cost
Digital Cable TV	N6152A W6152A	•	•	•	•
DVB-T/H/T2	N6153A W6153A	•	•	•	•
DTMB (CTTB)	N6156A W6156A	•	•	•	•
CMMB	N6158A W6158A	•	•	•	•
ISDB-T	N6155A W6155A	•	•	•	•

Free Trial License

Free 14-day trials of X-Series advanced measurement applications provide unrestricted use of each application's features and functionality on your X-Series analyzer. Redeem a trial license on-line today at www.agilent.com/find/X-Series_trial.

Flexible Software Licensing and Configuration

Choose from two license types:

- *Fixed, perpetual license:* Allows you to run the application in the X-Series analyzer in which it is initially installed
- *Transportable, perpetual license:* Allows you to run the application in the X-Series analyzer in which it is initially installed, plus it may be transferred from one X-Series analyzer to another (PXA/MXA/EXA)

Ordering Information

These applications can be installed at the time of instrument purchase or ordered as stand-alone items to upgrade an existing instrument. You can also run applications such as MATLAB and 89600B VSA software inside an X-Series signal analyzer. For ordering information visit www.agilent.com/find/xseriesapplications.

Web Link

www.agilent.com/find/xseriesapplications

- Flexible spectrum, modulation, and time analysis and troubleshooting
- Powerful 3GPP/WLAN/WiMAX/LTE analysis options
- Advanced tools for analyzing wireless signals
- Multi-channel and MIMO analysis
- PC-based, works with signal analyzers, scopes, modular instruments

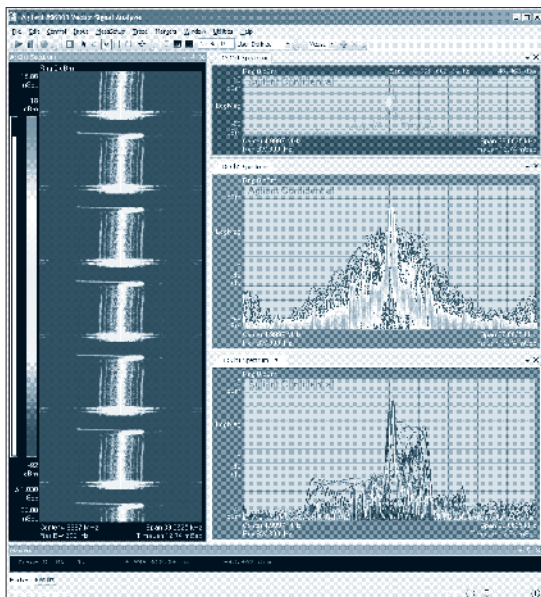

89600B VSA software showing spectrogram, digital persistence and cumulative history traces

The 89600B VSA Support over 70 Signal Standards and Modulation Types, Including:

- Commercial cellular communications including WCDMA and LTE
- MIMO signaling
- General purpose digital analysis including FSK, BPSK, QPSK, 16-1024QAM, APSK and Star QAM
- Wireless networking including WiMAX and WLAN
- Analog AM/FM/PM

Broad Selection of Advanced Tools for Signal Evaluation and Troubleshooting

- High resolution FFT-based spectrum analysis with spectrogram displays and full marker support
- Time domain analysis including time gating, CCDF, and auto-correlation
- Auxiliary features like signal record and playback, macros, math functions, and the convenience of on-screen hot spots for quick parameter changing

Compatible with Many Platforms

The PC-based VSA software runs on a laptop or in PC-based instruments. With support for more than 30 model numbers, you can access your signal anywhere in your signal block diagram from baseband (analog or digital) to IF and RF, from DC to 50 GHz, with bandwidths from 1 Hz to 30 GHz.

Supported platforms include:

- Spectrum and signal analyzers like the versatile PXA, MXA, EXA and CXA
- Scopes like the Infiniium 90000X, 9000, and Infiniium 6000, 7000
- Logic analyzers
- Modular instruments including LXI and N7109
- Simulation software including SystemVue and Simulink
- VSA software can also download captured signals to our signal generators

Software Update Service

With the 89601BU software update and subscription service you get new feature updates for your software automatically, as soon as they become available. One year of the service is included with each new 89600B VSA and it can also be ordered separately.

The 89600B VSA Software Offers a Variety of Licenses to Meet Your Needs

- PC/instrument license – enables operation on your PC or PC-based instrument
- Transportable license – a standard feature of the PC license is that it lets you move licenses between instruments or PCs so that if an instrument goes in for calibration or repair, you can move your VSA software to another analyzer and keep working
- Floating license – facilitates sharing the software between multiple users, one user at a time
- Trial license (14-day free trial) – download the software from www.agilent.com and use all of its features with any of its hardware (or recorded signals if hardware is not available) for 14 days

Powerful Modulation Analysis Options

Flexible modulation analysis (Option AYA)

Option AYA demodulates a wide range of standard communication formats, such as EDGE and GSM. It also offers a wide range of general purpose demodulators for FSK, BPSK, QPSK, offset QPSK, QAM, and VSB, all with user-settable symbol clock rate, bandwidth, filter type and alpha. You can even apply your own proprietary filtering by providing the filter's impulse or frequency response.

LTE FDD modulation analysis (Option BHD)

LTE TDD modulation analysis (Option BHE)

Gain greater insight into the performance of your LTE FDD and TDD capable devices using the 89600B VSA software LTE modulation analysis options. These advanced technology options provide RF and baseband engineers a comprehensive set of LTE signal analysis tools including:

- A rich selection of EVM measurements – Overall/Data/Pilot/RS EVM, EVM per carrier, symbol, resource block, channel and slot
- A compound constellation display, color-coded by active channel
- A frame summary table showing the power, EVM, and modulation of all active channels
- An error table with I/Q parameters, frequency and symbol clock error, CP type, and OS/PRS
- The symbol table with the demodulated raw bits
- MIMO analysis is fully supported

89601B
89601BN**3G modulation analysis (Option B7N)**

Evaluate and troubleshoot your 3G modulated wireless communications signals with Option B7N. Whether your signal is cdma2000 or W-CDMA, TD-SCDMA or 1xEV-DO, HSPA+ or 1xEV-DV, the tools and analysis flexibility in Option B7N will help you test your signal to its standard and troubleshoot the problem if the signal fails to meet its standard. You can purchase the modulation types separately as Option B7T (cdma2000/1xEV-DV), Option B7U (WCDMA/HSPA+), Option B7X (TD-SCDMA), or Option B7W (1xEVDO).

WLAN modulation analysis (Option B7R)

Agilent's industry leading WLAN signal analysis option for the 89600B VSA software offers:

- 802.11a OFDM modulation analysis
- 802.11b DSSS/CCK/PBCC modulation analysis
- 802.11g modulation analysis
- 802.11a/b/g standards-based testing

IEEE 802.11n MIMO modulation analysis (Option B7Z)

Analyzing an IEEE 802.11n MIMO signal is extraordinarily challenging because it is made up of multiple OFDM signals that transmit on the same frequency at the same time. The advanced troubleshooting and evaluation toolset provided by Agilent's IEEE 802.11n MIMO modulation analysis option is specifically designed to handle this challenge and more.

IEEE 802.16-2004 OFDM analysis (Option B7S)

Analyzing OFDM signals requires developers to think in the time and frequency domains simultaneously, so effective troubleshooting requires OFDM-specific signal analysis tools that can manipulate and break down the signal. The IEEE 802.16 OFDM analysis software helps you do this quickly and efficiently. Option B7S provides comprehensive coverage of the IEEE 802.16-2004 standard:

- All IEEE 802.16-2004 modulation formats, including BPSK, QPSK, 16QAM, and 64QAM
- TDD, FDD, and H-FDD
- Uplink and downlink
- Burst and continuous
- All frame lengths, guard intervals, and sampling factors
- Demodulation down to the raw bit level

MB-OFDM ultra-wideband modulation analysis (Option BHB)

Troubleshoot your WiMedia-based multi-band OFDM ultra-wideband PHY layer signals, such as those in certified wireless USB, with the industry's most complete set of easy-to-use measurement tools, providing you with an unparalleled view into your PHY layer signals. Use Option BHB running on the high performance Agilent oscilloscopes to help you identify the root causes of problems, sooner.

RFID modulation analysis (Option BHC)

Use the powerful measurements and displays of the 89600B software to troubleshoot RFID systems. Analyze both the forward (interrogator) and return (tag) signals. Use the built-in pre-sets for some of the RFID standards or manually set the demodulation format, line coding, and bit rate or tari.

IEEE 802.16e OFDMA analysis (Option B7Y)

Analyze your IEEE 802.16e OFDMA signal with the advanced troubleshooting tools offered in Option B7Y. Evaluate modulation performance by logical sub-channel, by burst and by zone. Analyze uplink and downlink burst formats, TDD and FDD and more.

Ordering Information

89601B VSA software (PC/instrument license)

89601BN VSA software (Network license)

- 200** basic vector signal analysis
- 300** hardware connectivity
- 105** ADS/SystemVue connectivity
- 106** Simulink connectivity
- AYA** flexible modulation analysis
- B7R** WLAN modulation analysis (802.11a/b/g/j/p)
- B7Z** 802.11n MIMO modulation analysis
- B7S** IEEE 802.16-2004 OFDM modulation analysis
- B7Y** IEEE 802.16 OFDMA modulation analysis
- B7T** cdma2000/1xEV-DV modulation analysis
- B7U** W-CDMA/HSDPA modulation analysis
- B7W** 1xEV-DO modulation analysis
- B7X** TD-SCDMA modulation analysis
- B7N** 3GPP analysis bundle (includes B7T, B7U, B7W, B7X)
- BHB** MB-OFDM ultra-wideband modulation analysis
- BHC** RFID modulation analysis
- BHD** LTE FDD modulation analysis
- BHE** LTE TDD modulation analysis

89601BU software update and subscription service, (PC/instrument license)

89601BNU software update and subscription service for 1 server (floating license)

Web Link

www.agilent.com/find/89600B

- All-digital-IF architecture offers outstanding accuracy and linearity
- Fast low-level spur search
- One-button power measurements with format-based setups
- Over 16 optional built-in measurement personalities
- Optional 80 MHz analysis bandwidth for carrier frequency up to 50 GHz

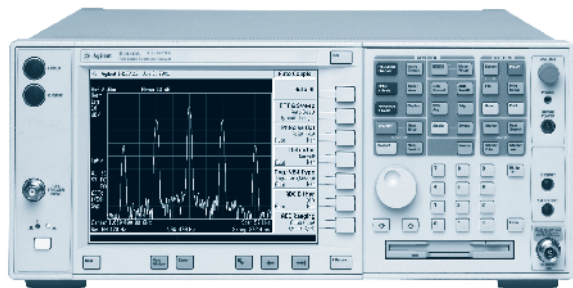

PSA Series high performance spectrum analyzer

PSA Series High Performance Spectrum Analyzer

The Agilent PSA Series high-performance spectrum analyzer offers a versatile feature set, specialized one-button measurements, and a leading-edge combination of flexibility, accuracy, analysis bandwidth and dynamic range for signals up to 50 GHz and beyond.

Measurement Accuracy

With the all-digital-IF architecture, a highly accurate internal reference signal and automatic internal alignment processes, the PSA Series achieves industry-leading accuracy, guaranteed by Agilent's high standard of specifications.

Swept Tune and FFT Analysis

The PSA allows signal analysis with swept tune or FFT analysis. The FFT capability significantly reduces sweep time in narrow span measurements and low-level spur search.

Analysis Bandwidth

For carrier frequencies up to 50 GHz, use PSA Option 122 (80 MHz BW digitizer) to analyze signals with up to 80 MHz information bandwidth. Analysis of complex digitally modulated signals is enhanced by the superb RF front-end and digital IF performance, which produces 78 dB of image-free dynamic range and < 1% of residual EVM. For measurements above 3 GHz, PSA Option 123 (switchable MW preselector bypass) ensures excellent frequency response and phase linearity in the microwave and millimeter-wave bands.

Gated Sweep

Analyze time-varying signals such as pulsed RF, time division multiple access (TDMA), interleaved and burst-modulated.

One-Button Power Measurements

The PSA Series offers a suite of power measurements for RF signals with a variety of radio format based setups. Referred to as PowerSuite, this standard feature of the PSA simplifies what were once difficult and tedious power measurements, allowing them to be accomplished with the touch of a button.

Measurements Beyond 50 GHz

With the optional external mixing feature (Option AYZ), the Agilent PSA (E4440A/46A/47A/48A) is capable of measuring millimeter-wave signals up to 325 GHz. The PSA supports Agilent 11970 Series harmonic external mixers (up to 110 GHz), 11974 Series preselected external mixers (up to 80 GHz), and third-party mixers (up to 325 GHz).

PSA-Based Measurement Personalities

Choose from over a dozen embedded measurement personalities. With the PSA you can perform specialized functions such as: phase noise for oscillator testing, noise figure for component qualifications, external source control for scalar network analysis, and others for various standard-based wireless connectivity and cellular communication measurements.

Phase Noise (Option 226)

Option 226 turns the PSA high-performance spectrum analyzer into a single-box phase noise tester up to 50 GHz.

Noise Figure (Option 219)

Option 219 provides fast, one-button noise figure and gain measurements from 200 kHz to 26.5 GHz. A 50 GHz internal preamplifier (Option 110) further enables nominal noise-figure performance to the maximum frequency of the PSA.

External Source Control (Option 215)

Option 215 enables the PSA to control a PSG, an ESG-C, or an MXG signal generator for scalar stimulus-response tests up to 50 GHz.

Flexible Digital Modulation Analysis (Option 241)

Option 241 allows you to easily trouble-shoot the design of digital communication systems by analyzing various digitally modulated signals – either in industry standard-based formats or your own custom formats.

W-CDMA (Option BAF)

Option BAF meets the complexity of W-CDMA measurement challenges by performing the 3GPP conformance tests and in-depth standard-based modulation analysis on both uplink and downlink W-CDMA signals.

HSDPA/HSUPA (Option 210)

Option 210 adds modulation analysis capabilities like analysis for HS-PDSCH in 16 QAM and HS-DPCCH for HSDPA (high speed downlink data packet access). HSUPA (high speed uplink data packet access), E-DPCCH and E-DPDCH can be demodulated for EVM and code domain analysis.

cdma2000 (Option B78)

Option B78 offers the logical upgrade path from IS-95 to IS-2000 testing. Measurements support both forward and reverse links.

1xEV-DO (Option 204)

Option 204 meets unique measurement challenges presented by the evolution to cdma2000 with 1xEV-DO Rev. O and Rev. A by testing based on 3GPP2 technical specification group cdma2000 (TSG-C) standards (C.S0032, C.S0033, and C.S0024-A).

TD-SCDMA (Options 211/212/213)

Options 211/212/213 measure uplink and downlink TD-SCDMA signals based on the 3GPP TD-SCDMA standard UTRA TDD 1.28 Mcps option, providing power measurements (Option 211), modulation analysis (Option 212), and analysis for HSDPA/8PSK (Option 213).

GSM with EDGE (Option 202)

Option 202 makes standard-based power and modulation measurements on signals with GSM (global system for mobile communications) or EDGE (enhanced data rates for GSM evolution) formats.

N9039 RF Preselector Control for EMI Receiver (Option 239)

Option 239 enables the PSA to control the Agilent N9039A RF preselector and form a CISPR 16-1-1 compliant EMI receiver. See the section on the EMI measurement receiver for details about how it works with the PSA.

Built-in Measuring Receiver Personality (Option 233)

Option 233 converts the general-purpose PSA spectrum analyzer into the key component of the metrology-grade N5531S measuring receiver.

E4440A
E4443A
E4445A
E4446A
E4447A
E4448A
N5531S

E4440A
E4443A
E4445A
E4446A
E4447A
E4448A
N5531S

N5531S Measuring Receiver

The Agilent N5531S measuring receiver is comprised of a PSA high performance spectrum analyzer with Option 233 (built-in measuring receiver personality), a P-Series precision power meter (N1911A or N1912A), and an N5532B (or N5532A previously) sensor module. It combines multiple precision measurement functions into one compact, integrated system that set the new industry standards for traceable, metrology-grade device calibrations up to 50 GHz.

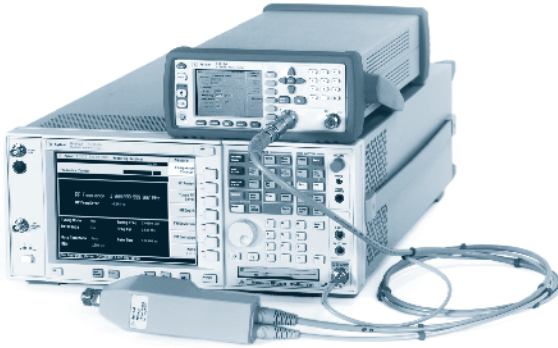

N5531S measuring receiver for traceable metrology-grade calibrations up to 50 GHz

- Absolute RF power: accuracy of power meter combined with a sensor module using N848x power sensor
- Tuned RF level (TRFL): up to 140 dBm sensitivity with level accuracy exceeding source/attenuator calibration demands
- Frequency counter: 0.001 Hz frequency resolution and up to -100 dBm sensitivity
- Analog modulation analysis: precise AM, FM, PM for verifying modulation quality of signal sources
- Optional audio analysis capabilities with high-impedance audio input (Option 107 required)
- N5532B sensor modules with single input connection up to 50 GHz for measurement integrity and productivity

Specifications

Frequency range

- E4443A: 3 Hz to 6.7 GHz (DC coupled), 20 MHz to 6.7 GHz (AC coupled)
- E4445A: 3 Hz to 13.2 GHz (DC coupled), 20 MHz to 13.2 GHz (AC coupled)
- E4440A: 3 Hz to 26.5 GHz (DC coupled), 20 MHz to 26.5 GHz (AC coupled)
- E4447A: 3 Hz to 42.98 GHz (DC coupled)
- E4446A: 3 Hz to 44 GHz (DC coupled)
- E4448A: 3 Hz to 50 GHz (DC coupled)

Analysis bandwidth

- Option B7J or 241: 10 MHz
- Option 140: 40 MHz (except for E4447A)
- Option 122: 80 MHz (except for E4447A)

Phase noise

Note: 20 to 30 °C, CF = 1 GHz

Offset	Specification	Typical
100 Hz	-91 dBc/Hz	-96 dBc/Hz
1 kHz	-103 dBc/Hz	-108 dBc/Hz
10 kHz	-116 dBc/Hz	-118 dBc/Hz
100 kHz	-122 dBc/Hz	-124 dBc/Hz
1 MHz	-145 dBc/Hz	-147 dBc/Hz
10 MHz	-155 dBc/Hz	-157.5 dBc/Hz

Third-order intermodulation distortion (TOI)

Note: Two -30 dBm tones at input mixer with tone separation > 15 kHz, 20 to 30 °C

		Specification	Typical
E4443A/45A/40A	1 GHz	+16 dBm	+19 dBm
	2 GHz	+17 dBm	+19 dBm
	4 GHz	+15 dBm	+18 dBm
	13 GHz	+8 dBm	+11 dBm
	26.5 GHz	+12 dBm	+14 dBm
E4447A/46A/48A	1 GHz	+17 dBm	+20 dBm
	2 GHz	+18 dBm	+21 dBm
	4 GHz	+16 dBm	+21 dBm
	13 GHz	+12 dBm	+15 dBm
	26.5 GHz	+12 dBm	+15 dBm
	44 GHz	—	+12.5 dBm (nominal)
	50 GHz	—	+12.5 dBm (nominal)

Displayed average noise level (DANL)

Note: Input terminated, sample or average detector, average type = log, 20 to 30 °C, zero span, swept, nominalized to 1 Hz RBW, 0 dB attenuation

		Specification (without preamp)	Specification (preamp on: Option 1DS/110)*
E4443A/45A/40A	1 GHz	-154 dBm	-168 dBm/-166 dBm
	2 GHz	-153 dBm	-167 dBm/-166 dBm
	4 GHz	-152 dBm	NA/-165 dBm
	13 GHz	-154 dBm	NA/-163 dBm
	26.5 GHz	-154 dBm	NA/-159 dBm
E4447A/46A/48A	1 GHz	-153 dBm	-166 dBm/-165 dBm
	2 GHz	-152 dBm	-165 dBm/-165 dBm
	4 GHz	-152 dBm	NA/-165 dBm
	13 GHz	-151 dBm	NA/-162 dBm
	26.5 GHz	-140 dBm	NA/-155 dBm
	44 GHz	-131 dBm	NA/-146 dBm
	50 GHz	-127 dBm	NA/-140 dBm

* Two internal preamp options are available for the PSA and they are mutually exclusive: 1DS and 110. Option 1DS covers 100 kHz through 3 GHz and Option 110 covers 10 MHz through the maximum frequency of the PSA model

Ordering Information

PSA Series spectrum analyzer

- E4443A 3 Hz to 6.7 GHz
- E4445A 3 Hz to 13.2 GHz
- E4440A 3 Hz to 26.5 GHz
- E4447A 3 Hz to 42.98 GHz
- E4446A 3 Hz to 44 GHz
- E4448A 3 Hz to 50 GHz

Examples of PSA Options:

- E444xA-226 phase noise measurement personality
- E444xA-219 noise figure measurement personality
- E444xA-AYZ external mixing (except for E4443A/45A)
- E444xA-122 80 MHz analysis bandwidth (except for E4447A)
- E444xA-1DS internal RF preamplifier, 100 kHz to 3 GHz (excludes Option 110)
- E444xA-110 internal preamplifier 10 MHz to the max frequency of PSA (excludes Option 1DS)
- E444xA-BAF W-CDMA measurement personality
- E444xA-B7J digital demodulation hardware
- E444xA-241 flexible digital modulation analysis personality
- E444xA-233 built-in measuring receiver personality

For more ordering information please refer to "PSA configuration guide" (5989-2773EN)

Web Link

- www.agilent.com/find/psa
- www.agilent.com/find/psa2pxa
- www.agilent.com/find/n5531s

- Frequency range 100 Hz to 26.5 GHz
- Analysis bandwidth 10 MHz
- Phase noise –101 dBc/Hz
- TOI: +16 dBm
- DANL: –167 dBm/Hz (with PA on and Option 1DR, 1D5)
- Wide set of built-in power measurements
- Integrated measurements for noise figure and phase noise
- RMS, quasi-peak, peak detectors and EMI bandwidth

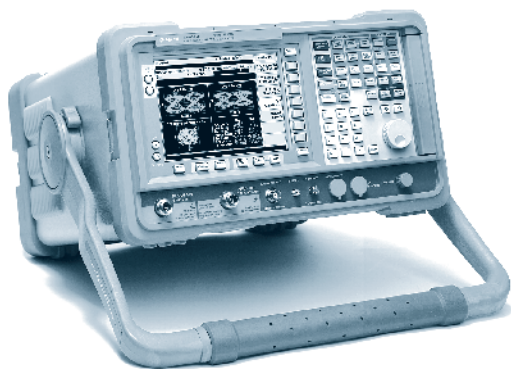

ESA Series Spectrum Analyzers

ESA Express Analyzers Provide Ordering Ease, Fast Delivery, and Best Value

The ESA analyzer is available in three “express option” choices. Express analyzer options are based on the most frequently ordered ESA configurations and most popular options. The express analyzer options simplify the ordering process while maintaining the flexibility of the ESA platform. Just select the ESA express analyzer that meets your needs and budget. Express analyzers are favorably priced and provide faster delivery. For unique requirements, the ESA analyzer may be custom configured from the complete set of available options.

ESA Basic Analyzer (Option BAS or BTG)

For basic, quality, spectrum analysis on RF or microwave signals at an affordable price. The basic analyzer provides general spectrum analysis with the speed, accuracy and dynamic range to give you confidence in your measurement results.

- 1.5 GHz, 3.0 GHz, and 26.5 GHz frequency range
- 1.1 dB overall amplitude accuracy
- 100 Hz RBW (optional)
- +7.5 dBm TOI
- 5 minute warm-up to guaranteed measurement accuracy
- Rugged design, weather resistant, snap on battery pack
- Multifomat RF power measurement suite

ESA Standard Analyzer (Option STD or STG)

The standard analyzer includes a wide set of built-in functions and features while maintaining the flexibility to add the most popular ESA options.

- 0.4 dB amplitude accuracy (95% confidence level)
- 10 Hz RBW (1 Hz with option)
- +16 dBm TOI
- FM demodulation

ESA Communication Test Analyzer (Option COM)

Expand on the leading performance and functionality of the standard analyzer with the addition of built-in demodulation hardware. When combined with the communication focused measurement personalities or the Agilent 89600B VSA software, this express analyzer makes a powerful tool for communications device development.

- 0.4 dB amplitude accuracy (95% confidence level)
- 1 Hz RBW
- +16 dBm TOI
- Precision frequency reference
- 10 MHz demodulation bandwidth
- Optional communications focused applications such as flexible modulation analysis, GSM/EDGE, and cdmaOne
- Link to the popular Agilent 89600B VSA software for fully flexible demodulation analysis and in depth trouble shooting tools

E4411B
E4402B
E4404B
E4405B
E4407B

Performance

Amplitude Accuracy

The ESA offers performance in accuracy with a guaranteed overall amplitude accuracy of less than 1.0 dB error (< 3 GHz) based on traceable and warranted specifications. Other economy-class analyzers may specify only typical performance levels. The ESA excels in overall amplitude accuracy whether comparing guaranteed specifications or expected levels of performance.

Frequency Accuracy

The ESA provides a warranted internal frequency reference that may not be available in other economy-class analyzers. Further, the ESA has excellent frequency readout accuracy, a function of the frequency reference error as well as the span error coefficient, RBW, center frequency, and number of sweep points.

Measuring Low Level Signals such as Spurs

The ESA offers top performance thanks to its optional built in low noise, high gain preamplifier. Achieving a displayed average noise level (DANL) of better than –167 dBm.

Measuring Lower Level Signals Next to Higher Power Signals

A spectrum analyzer's dynamic range is a function of both its displayed average noise level (DANL) performance and its intermodulation distortion performance. The ESA third order intermodulation distortion performance is +16 dBm third order intercept (TOI) (+7.5 for basic analyzer configurations). In addition, the ESA features a standard 5 dB step attenuator making it easy to optimize the spectrum analyzer's mixer level settings to achieve the best dynamic range.

5 Minute Warm Up Time

Most spectrum analyzers take 15 minutes to 1 hour to warm up before the specifications in the data sheet are valid. Not with the ESA. The ESA takes only 5 minutes to warm-up so technicians and engineers spend little time waiting for instrument stabilization.

Automatic Background Alignment

The automatic, internal background alignment feature gives consistently accurate results over varying temperatures. This is especially beneficial when operating the ESA outdoors or in varying temperature conditions. Further, the ESA provides guaranteed performance specifications over a wide temperature range of 0 to 55 degrees centigrade.

Express Analyzer Features and Performance Summary

See the ESA data sheet for more specifications and details. (<http://cp.literature.agilent.com/litweb/pdf/5968-3386E.pdf>)

	Basic analyzer (Option BAS/BTG)	Standard analyzer (Option STD/STG)	Communication test analyzer (Option COM)	ESA optional performance with custom configuration	
Frequency range	9 kHz to 1.5, 3.0, 26.5 GHz	9 kHz to 3.0, 6.7, 13.2, 26.5 GHz	9 kHz to 3.0, 6.7, 13.2, 26.5 GHz	30 Hz to 3.0, 6.7, 13.2, 26.5 GHz (Option UKB)	
Speed	Sweep time (< 3 GHz)	4 ms to 4000 s	1 ms to 4000 s	1 ms to 4000 s (Option 1D5)	
	Zero span sweep	4 ms to 4000 s	50 ns to 4000 s	25 ns to 4000 s (Option B7D/B7E)	
	Remote trace Transfer	30/sec	45/sec	45/sec	
	Warm up time	5 mins	5 mins	5 mins	
Dynamic range	Resolution bandwidth	100 Hz to 5 MHz with Option	10 Hz to 5 MHz 1 Hz with Option 1D5/1DR	1 Hz to 5 MHz (Option 1DR and 1D5)	
	Phase noise 10 kHz	-93 dBc/Hz + 20 LogN	-101 dBc/Hz ¹ + 20 LogN	-101 dBc/Hz ¹ + 20 LogN (Option 120)	
	Measurement range (Option 1DR)	-130 dBm to +30 dBm	-140 dBm ² to +30 dBm -156 dBm ² with Option 1DS	-150 dBm to +30 dBm -167 dBm with Option 1DS	-167 dBm to +30 dBm (Options 1DR, 1D5, 1DS)
	TOI (for spurious free dynamic range (SFDR))	+7.5 dBm	+16 dBm	+16 dBm	+16 dBm
Accuracy	Frequency accuracy	±101 Hz	±101 Hz	±101 Hz	
	Span accuracy	±0.5%	±0.5%	±0.5%	
	Amplitude accuracy	±1.1 dB	±0.4 dB	±0.4 dB	
Measurement capability	Sample of available features	PowerSuite one button measurements, IntuiLink connectivity to MS Office, amplitude corrections	Basic features plus: log sweep, segmented sweep, optional preamp, CCDF function, FM demodulation, variable sweep points	Basic and standard features plus: digital demodulation capability	
	Available measurement applications	Cable TV	Noise figure, phase noise, cable fault, cable TV	Flexible demodulation with 89600B software, modulation analysis, GSM/EDGE, cdmaOne, noise figure, phase noise	
	Future upgrades	Limited	Available	Available	

¹ With Options 1DS and 1DR

² Enhanced performance is available with different option configurations. Up to -167 dBm performance is available with Options 1DR, 1D5, and 1DS

Measurements Made Easy

One-button power measurements with standards-based setups	Quick setup and measurement time with one-button RF power measurements for all major 2G/3G, WLAN, and digital video formats
Optimize reference level	Button included with the built in power measurements simplifies the setting up of your measurement by automatically adjusting the reference level and attenuator based on signal level
Segmented sweep	Saves measurement and setup time by viewing in one sweep only the frequency spans of interest. Paste together up to 32 discontinuous frequency or zero spans in one sweep. Eliminate multiple setups and sweeping through unwanted frequencies
Log sweep	Display swept measurements on a logarithmic scale of the frequency domain
Zoom windows	Split screen display shows wide spans while zooming in on signals of interest
Marker functions	Provides digital resolution of measurement details through peak search, continuous peak search, delta markers, marker table, and carrier-to-noise ratio. Signal track keeps unstable signals centered on the screen while band power calculates total power between user-defined limits
Frequency counter	With 1 Hz resolution, minimizes the need for an external frequency counter
Softkey/hardkey interface	Provides a simple user interface while retaining access to sophisticated features
Built-in help button	Eliminates carrying manuals into the field to determine softkey/hardkey functions and remote SCPI commands
Limit lines	Built-in limit lines and pass/fail messages simplify testing. EMI limit lines are available
Built-in clock/calendar	Provides time stamps on both stored and printed data
Automatic overload protection	Protects RF input from overly large signals (E4411B)
Automatic printer setup	Identifies connected most Hewlett-Packard printer models automatically
IntuiLink software	PC software provides easy transfer of measurement results into Microsoft Excel and Microsoft Word. Download from www.agilent.com/find/intuilink
SCPI programming interface	Allows full remote control and programming of the ESA spectrum analyzer
IVI® COM drivers	Provides interface for programming in many environments, including Visual Studio®, LabVIEW, and Agilent VEE. Drivers may be found at www.agilent.com/find/drivers

Ordering Information – Custom Configurations

Equivalent Options and bundles

Option		Equivalent Option(s)	Comments
ESA-L Series	BAS – basic analyzer	A4J	Order BAS or BTG to get best delivery and price
	BTG – basic analyzer with TG	A4J, 1DN	Order BAS or BTG to get best delivery and price
ESA-E Series	STD – standard analyzer	AYX, BAA	Order STD, STG, or COM to get best delivery and price
	STG – standard analyzer with TG	AYX, BAA, 1DN	Order STD, STG, or COM to get best delivery and price
	COM – communication test analyzer	B7D, B7E, 1D5, 1DR, BAA, 231	Order STD, STG, or COM to get best delivery and price
	B75 – performance bundle	1DR, 1DS, 1D5	Only available on the standard analyzers (Express Option STD or STG)
	304 – <i>Bluetooth</i> premium bundle	228, 106, B7D, B7E, 1DS, 1D5	Options 106 and 228 are not available outside of the Option 304 bundle

E4411B
E4402B
E4404B
E4405B
E4407B

ESA-L Series Custom Analyzer

All custom ESA-L Series include a 75 Ω input port

			Comments
Available models	E4411B (9 kHz to 1.5 GHz)		Custom configuration not available for E4403B or E4408B
Included Options	GPIB connection	A4H	Standard on every instrument unless 1AX is ordered; occupies 1 expansion slot
	IntuiLink PC connectivity software	Included	Connects to Microsoft Word and Excel; download for free from www.agilent.com/find/intuilink
Available Options	75 ohm impedance	1DP	
	Replace GPIB connection (A4H) with serial port	1AX	Not compatible with Option A4H; occupies 1 expansion slot
	IF sweep, and video output ports	A4J	Occupies 1 expansion slot
	Narrow resolution bandwidths	1DR	100 Hz minimum on ESA-L Series
	75 ohm tracking generator (1 MHz to 1.5 GHz)	1DQ	Requires Option 1DP
Future upgrades	8590-Series programming code compatibility	290	Free download from www.agilent.com/find/esa ; no license required
Future upgrades	Limited upgrades are available		For more details about upgrades, go to: www.agilent.com/find/saupgrades

Web Link

www.agilent.com/find/esa

8564EC
8565EC

- Continuous sweep up to 40 or 50 GHz
- Resolution bandwidth of 1 to 100 Hz digitally implemented for measurement speed
- Standard external mixing feature
- Precision timebase and 1 Hz counter resolution
- Class 3 MIL-rugged



856xEC midrange spectrum analyzer

856xEC Series Midrange Spectrum Analyzers

The Agilent 856xEC Series midrange spectrum analyzers combine millimeter-wave (mm-wave) capability, outstanding phase noise, and wide dynamic range in a Class 3 MIL-rugged package built to withstand harsh experimental conditions.

The RF and microwave models of the 856xEC Series (8560EC/61EC/62EC/63EC) have been discontinued and replaced with Agilent's X-Series, primarily the N9020A MXA midrange signal analyzer. The mm-wave models, 8564EC and 8565EC, are still available.

8564EC and 8565EC mm-Wave Spectrum Analyzers

Whether you want to measure the harmonics of a 15 GHz oscillator or the noise sideband of a 38 GHz carrier, the 8564EC and the 8565EC simplify measurement setup. A single coaxial connection is all you need to measure signals from 9 kHz (30 Hz optional) to 50 GHz. Preselection minimizes images and multiple responses at higher frequencies.

The standard 8564EC covers frequencies of 9 kHz to 40 GHz and the 8565EC covers 9 kHz to 50 GHz. Both have optional low-end coverage to 30 Hz and are preselected above 2.75 GHz.

Measurements Beyond 50 GHz

External mixing is a standard feature of the 856xEC. Combined with Agilent's 11974 Series external mixers, the preselection can be extended to 75 GHz. The unpreselected frequency range can be extended to 110 GHz using Agilent's 11970 Series external mixers, and to 325 GHz using mixers from other manufacturers.

Precision Frequency and Amplitude

Measure frequency accurately using the built-in frequency counter. A standard precision frequency reference, with an aging rate of 1×10^{-7} per year, provides confidence in frequency measurement accuracy.

Amplitude measurement uncertainty can be reduced using the amplitude correction (AMPCOR) feature offered standard with the 856xEC. AMPCOR allows you to enter up to 200 amplitude correction points to compensate for sources of amplitude uncertainty, such as cable losses, preamplifier gain and the spectrum analyzer's frequency response.

Digital Resolution Bandwidth

Digitally-implemented resolution bandwidths of 1, 3, 10, 30 and 100 Hz with a narrow 5:1 shape factor allow you to easily view close-in, low level signals.

Digitized Time-Domain Sweeps

Digitized time-domain (zero span) sweeps use markers, trace math, and trace storage for measurements such as rise/fall, pulse widths and time between events.

Specifications

Frequency range

- 8564EC: 9 kHz to 40 GHz, 30 Hz to 40 GHz (with Option 006)
- 8565EC: 9 kHz to 50 GHz, 30 Hz to 50 GHz (with Option 006)

Phase noise

(CF ≤ 1 GHz)

Offset	Specification
100 Hz	< -88 dBc/Hz
1 kHz	< -97 dBc/Hz
10 kHz	< -113 dBc/Hz
100 kHz	< -127 dBc/Hz

Third order intermodulation

Note: Two -30 dBm tones at input mixer with tone separation ≥ 1 kHz

8564EC/65EC	Specification	Typical
1 GHz	+11 dBm	—
2 GHz	+11 dBm	—
4 GHz	+15 dBm	—
13 GHz	+7.5 dBm	—
26.5 GHz	+7.5 dBm	—
40 GHz	—	+12.5 dBm (nominal)
50 GHz	—	+12.5 dBm (nominal)

Displayed average noise level (DANL)

Note: 0 dB attenuation, 1 Hz RBW

8564EC/65EC	Specification
1 GHz	-145 dBm
2 GHz	-145 dBm
4 GHz	-147 dBm
13 GHz	-143 dBm
26.5 GHz	-136 dBm
40 GHz	-130 dBm
50 GHz	-127 dBm

Ordering Information

856xEC Series midrange spectrum analyzer

8564EC 9 kHz to 40 GHz

8565EC 9 kHz to 50 GHz

Examples of 856xEC Options:

856xEC-001 add second IF output; rear panel connector

856xEC-005 add alternate sweep out

856xEC-006 low end range to 30 Hz

856xEC-104 do not include mass memory module

For more ordering information please refer to

8560EC Series spectrum analyzers and accessories, configuration guide, literature number 5968-8155E

Web Link

www.agilent.com/find/8560EC

- **Measurement speed: minimum non-zero span sweep time: 10 ms**
- **Resolving power: RBW: 10 Hz to 1 MHz in 1-3-10 steps**
- **Sensitivity: DANL: -148 dBm with preamp**
- **Built-in power measurements: channel power, OBW, ACP, SEM and TOI**
- **Built-in power meter function with Agilent U2000 Series power sensor support**
- **Optional tracking generator and preamplifier**

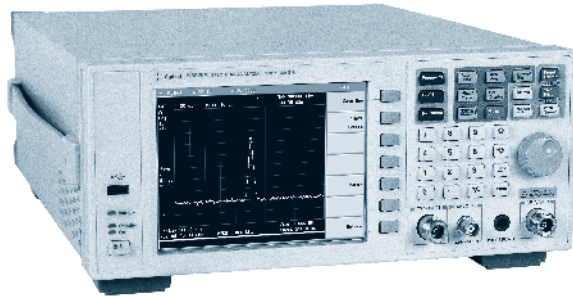

The Agilent N9320B RF spectrum analyzer is one of the new products in Agilent low cost RF instrument family, offering excellent price/performance for customers in consumer electronics manufacturing, bench repair, base station installation and maintenance, and education teaching lab, as well as entry level research and development.

Power Measurement and Automated Test Programming Features

- Digital IF enables dramatic improvements in power measurement accuracy
- Supports Agilent U2000 Series power sensor for high accurate RF and MW power measurements
- Built-in 1-button power measurement suite offers channel power, ACP, OBW, SEM and TOI measurements
- Optional EMI filter provides 200 Hz, 9 kHz, 120 kHz and 1 MHz RBW bandwidth (6 dB down) for EMC pre-compliance tests
- AM/FM, ASK/FSK demodulation metrics, offers demodulation analysis for AM/FM ASK/FSK signals
- Provides industry standard SCPI language support and flexible connectivity choices with USB, LAN and GPIB. Plus, SCPI code compatibility with Agilent ESA-L Series for easy instrument replacement

Engineered for the Best Spectrum Visibility

In your R&D, QA or university research lab, you want to know as much measurement detail as possible about your products and designs. The N9320B offers the best-in-class spectrum visibility.

- 10 Hz minimum RBW distinguishes closely spaced signals easily
- -148 dBm DANL reveals low level signals clearly
- 4 traces display and 12 markers allows you easily identify and compare signal details

Integrated Solution for the Modern RF Teaching Lab

One of the best ways to improve students' learning efficiency for RF related curriculums is to combine lectures with hands-on labs. The N9320B is an excellent price-performance fit for educational purposes. Whether you wish to combine the N9320B analyzer with the Agilent N9310A RF signal generator for basic RF concept labs, or enhance your RF circuit labs with the N9320B and its optional RF training kit (option code: N9320B-TR1), you will find adopting Agilent's RF education solution efficient and effective.

Specifications

Frequency

- Range
 - 9 kHz to 3.0 GHz, AC coupled
 - 100 kHz to 3.0 GHz, preamp on
- Resolution: 1 Hz

Frequency readout accuracy

- Marker resolution: (Frequency span)/(number of sweep point - 1)

Frequency counter

- Resolution: 1 Hz, 10 Hz, 100 Hz, 1 kHz, selectable

Resolution bandwidth (RBW)

- Range: 10 Hz to 1 MHz, in 1-3-10 sequence, -3 dB bandwidth
- Accuracy: $\pm 5\%$

Video bandwidth range

- 1 Hz to 3 MHz, in 1-3-10 sequence

Sweep time

- Range:
 - 10 ms to 1000 s, Span > 0 Hz
 - 6 μ s to 200 s, Span = 0 Hz
- Sweep mode: Continuous, Single

Phase noise

- Offset from CW signal
 - 10 kHz: < -88 dBc/Hz, typically < -90 dBc/Hz
 - 100 kHz: < -100 dBc/Hz, typically < -102 dBc/Hz
 - 1 MHz: < -110 dBc/Hz, typically < -112 dBc/Hz

Residual FM

- ≤ 100 Hz peak to peak in 100 ms, 1 kHz RBW, 1 kHz VBW

Displayed average noise level (DANL)

- Preamp off:
 - 9 to 100 kHz < -90 dBm Nominal
 - 100 kHz to 1 MHz < -90 dBm - 3 x (f / 100kHz) dB
 - 1 to 10 MHz < -124 dBm
 - 10 MHz to 3 GHz < -130 dBm + 3 x (f / 1 GHz) dB
- Preamp on:
 - 100 kHz to 1 MHz < -108 dBm - 3 x (f / 100kHz) dB
 - 1 to 10 MHz < -142 dBm
 - 10 MHz to 3 GHz < -148 dBm + 3 x (f / 1 GHz) dB

Ordering Information

N9320B-PA3 3 GHz preamplifier

N9320B-TG3 3 GHz tracking generator

N9320B-AMA AM/FM demodulation metrics

N9320B-EMF EMI filter

N9320B-DMA ASK/FSK demodulation metrics

N9320B-G01 GPIB interface

N9320B-1HB handle and bumpers

N9320B-1CM rack-mount kit

N9320B-1TC hard transit case

N9320B-UK6 commercial calibration certificate with testing data

N9320B-TR1 RF training kit

Warranty and service

R-51B-001-3C 1-year return-to-Agilent warranty extended to 3 years

Calibration

R-50C-011-3 Agilent calibration upfront support plan, 3-year coverage

Web Link

www.agilent.com/find/n9320b

N9340B
N9342C

- Frequency range: 100 kHz to 3 GHz, 100 kHz to 7 GHz
- Spectrum monitor and interference analyzer
- Built-in tracking generator
- AM/FM and ASK/FSK modulation analysis¹
- Innovative task planner enables routine test automation²
- High accuracy power measurement with Agilent U2000 Series USB power sensor
- Built-in GPS receiver and GPS antenna²



Field testing just got easier with Agilent HSA

The Agilent handheld spectrum analyzer (HSA) is designed to excel in the field. Whether you are installing and maintaining RF systems, doing on-site troubleshooting, monitoring an RF environment, or analyzing interference, you can always rely on the Agilent HSA for fast and accurate measurements. There are currently two models available within the HSA family. The new N9342C offers frequency coverage up to 7 GHz and the N9340B offers coverage up to 3 GHz. Both models measure from as low as 9 kHz, or even lower with the low frequency performance enhancement option¹.

Exceptional Performance

- **Fast sweep speed:** N9340B sweep speed at full span is less than 120 ms and its non-zero span sweep speed is 10 ms minimum. The fast sweep speed helps users locate and identify elusive and transient interference signals. It requires less time to measure across the span and you need not wait to see the scan
- **Best-in-class sensitivity:** Agilent HSA provides the lowest-in-class DANL which helps users detect lower level signals and gives a more complete understanding of the spectrum
N9340B: -144 dBm
N9342C: -154 dBm with preamplifier on
- **Best resolution ability:** Agilent HSA provides the best resolution ability with the narrowest RBW of 30 Hz to 1 MHz in a 1-3-10 sequence, making it possible to resolve close-in signals. The narrow RBW also means the least noise is introduced by the N9340B for the overall lowest DANL
- **Lowest SSB phase:** Agilent HSA achieves the lowest SSB phase noise, which also helps detect low signals (spurious or noise) close to the carrier which would otherwise be missed
N9340B: -87 dBc/Hz
N9342C: -91 dBc/Hz, 30 kHz offset

¹ Currently available only on N9340B

² Currently available only on N9342C

Powerful Features to Address Field Applications

- **Spectrogram monitoring:** The optional spectrogram monitoring feature on Agilent HSA allows the user to view the behavior of varying signal parameters in three dimensions with a spectrogram. Users can also continuously monitor and save spectrogram data automatically over time, not only to the analyzer's internal memory or a USB flash drive, but also directly to a PC. Two markers provide details of the spectrogram. Find the strongest interference with the marker peak search function. When the pass/fail function is turned on, use the marker to quickly identify the previous/next failed frame. With spectrogram monitoring feature, the Agilent HSA can provide unattended monitoring of communication systems capturing performance or intermittent events like interference over extended periods of time – days rather than hours
- **Built-in tracking generator:** Use the HSA's optional tracking generator (frequency up to 3 GHz for N9340B, 7 GHz for N9342C) to measure two-port transmission of filters and amplifiers, e.g. insertion loss, amplifier gain, and filter passband. The tracking generator output level is adjustable
- **AM/FM, ASK/FSK demodulation analysis¹:** AM/FM, and ASK/FSK demodulation analysis features allow users to demodulate and analyze AM/FM and ASK/FSK signals in many applications. Measurement metrics, symbol, waveform, and eye diagram are available for users for analysis. User definable limits provide Pass/Fail indicators for metrics. For reports and post-analysis, the waveform with metrics and setup parameters can be saved
- **Built-in GPS²:** N9342C HSA with built-in GPS ensures measurements are being taken at the correct location using GPS information (longitude, latitude, and altitude), tagged to each trace. The internal GPS antenna provides field convenience, while an SMA female-type connector is also available for an external GPS antenna
- **Task planner²:** N9342C HSA offers an innovative task planner to make RF testing easier and to boost your work efficiency to a new level. The task planner helps save up to 95% of test setup time, enables test automation following the pre-defined test sequence, automatically generates data logs and reports after the test
- **High accuracy power measurement:** The Agilent HSA supports high-accuracy, USB plug-and-play power measurements as standard when connected to an Agilent U2000 Series USB power sensor. Make true average power measurements for all signal types with wide dynamic range up to 18 GHz with just the press of a button
- **xDSL and IBOC measurements¹:** With hardware Options XDM and IBC, the N9340B HSA supports measurements on ADSL, ADSL2+, VDSL networks, and in-band on-channel (IBOC) measurement capabilities. It provides very good sensitivity with low displayed average noise levels (DANL) to meet the mask requirements over ADSL frequency ranges, from 9 kHz to 12 MHz. The XDM Option can also be used for other applications which require improved DANL and phase noise at frequencies from 9 kHz to 12 MHz
- **One-button power measurements:** The Agilent N9340B supports one-button measurements of occupied bandwidth, channel power and adjacent channel power ratio. This virtually eliminates set-up time in the field
- **Security features²:** N9342C HSA supports optional security features to erase all the customer data in the instrument memory for applications in a secure environment

Optimized Usability Enhances Field Test Productivity

- The Agilent HSA's rugged design makes it tough enough to meet military customers' requirements. Apart from its compact and rugged construction, the large rubberized grips that wrap around both ends provide additional robust protection from rough handling. The fanless design and sealed keypad make it moisture resistant and dust-proof
- The new 6.5" TFT LCD with 640 x 480 pixel resolution provides a superior, bright and clear trace for indoor and outdoor use. There is no need to operate in the shade
- The Agilent HSA is installed with back-lit keys for night use. Users can see the keys clearly even in the dark. The built-in light sensor can be activated to adjust the display and key brightness to adapt to environmental conditions
- The Agilent HSA, with superior power management, provides > 4 hours battery operating time. With optional automotive battery charger, Agilent HSA becomes an ideal tool for field use
- Optional 3-in-1 ergonomic backpack ensures comfort and frees up your hands when conducting field tests
- The Agilent HSA offers USB connectivity for PC control and easy data transfer to a USB memory stick. USB memory stick support makes data transfer in the field more convenient. PC control via the USB interface makes test and measurement more efficient

Agilent HSA Key Specifications

Frequency range

- N9340B: 100 kHz to 3.0 GHz
- N9342C: 100 kHz to 7.0 GHz

Phase noise

Offset	N9340B	N9342C
30 kHz	-87 dBc/Hz (typical)	-86 dBc/Hz, -91 dBc/Hz (typical)
100 kHz	-100 dBc/Hz (typical)	-97 dBc/Hz, -103 dBc/Hz (typical)
1 MHz	-120 dBc/Hz (typical)	-117 dBc/Hz, -121 dBc/Hz (typical)

Third-order intermodulation distortion (TOI)

N9340B	N9342C
Two -20 dBm, reference level = -10 dBm, center frequency 300 MHz, frequency Separation = 200 kHz	Two -20 dBm tones at the input, spaced by 100 kHz, input attenuation 0 dB, preamp off, reference level -30 dBm signal at input mixer
+10 dBm	+10 dBm, 300 MHz to 7 GHz +7 dBm, 50 MHz to 300 MHz

Displayed average noise level (DANL)

N9340B

RBW = 30 Hz, VBW = 3 Hz, input terminated 50 Ohm, 0 dB attenuation, RMS detector

	Specification (without preamp)	Specification (preamp on)
100kHz to 1 MHz	-90 dBm	-115 dBm
1 to 10 MHz	-110 dBm	-128 dBm
50 MHz	-126 dBm (typical)	-146 dBm (typical)
10 MHz to 1.5 GHz	-124 dBm	-144 dBm
1.5 to 3.0 GHz	-117 dBm	-136 dBm
3.0 to 4.5 GHz	-137 dBm	-155 dBm
4.5 to 6.0 GHz	-133 dBm	-152 dBm
6.0 to 7.5 GHz	-128 dBm	-148 dBm

N9342C

RMS detector, trace averaging > 40, 0 dB input attenuation, input terminated 50 Ohm, 1 kHz resolution bandwidth, normalized to 1 Hz, 20 to 30 °C

	Specification (without preamp)	Specification (preamp on)
100 kHz to 1 MHz	-110 dBm, typical -129 dBm	-133 dBm, typical -152 dBm
1 to 10 MHz	-130 dBm, typical -148 dBm	-150 dBm, typical 165 dBm
10 to 500 MHz	-144 dBm, typical -148 dBm	-163 dBm, typical 163 dBm
500 MHz to 2.5 GHz	-143 dBm, typical -147 dBm	-161 dBm, typical -164 dBm
2.5 to 4 GHz	-142 dBm, typical -146 dBm	-160 dBm, typical -163 dBm
4 to 6 GHz	-140 dBm, typical -144 dBm	-157 dBm, typical -160 dBm
6 to 7 GHz	-138 dBm, typical -142 dBm	-152 dBm, typical -156 dBm

Ordering Information

Agilent HSA N9340B

Agilent N9340B handheld spectrum analyzer (HSA), technical overview (5989-7847EN)

- N9340B-INM** extended spectrogram monitoring
- N9340B-XDM** N9340B with low frequency performance enhancement and xDSL measurement capability
- N9340B-IBC** N9340B with low frequency performance enhancement and AM/FM In-Band On-Channel IBOC measurement
- N9340B-PA3** 3 GHz preamplifier
- N9340B-TG3** 3 GHz tracking generator
- N9340B-AMA** AM/FM modulation analysis
- N9340B-DMA** ASK/FSK modulation analysis
- N9340B-UK6** commercial calibration certificate with test data included
- N9340B-1TC** hard transit case
- N9340B-1DC** automotive 12 V DC adaptor
- N9340B-BAT** spare battery pack
- N9340B-ADP** spare AC/DC adaptor
- N9340B-BCG** external battery charger
- N9340B-TAD** adaptor Type-N(m) 50 Ω to Type-N (f) 75 Ω DC to 1 GHz
- N9340B-ABA** manual – English
- N9340B-AB2** manual – Chinese
- N9340B-ABJ** manual – Japanese

Agilent HSA N9342C

Agilent N9342C handheld spectrum analyzer (HSA), data sheet (5990-5587EN)

- N9342C-PA7** pre-amplifier, 100 kHz to 7.0 GHz
- N9342C-PWM** USB power sensor support
- N9342C-SIM** spectrum monitor with spectrogram record and playback
- N9342C-TG7** tracking generator, 5 MHz to 7.0 GHz
- N9342C-GPS** built-in GPS receiver, with built-in GPS antenna
- N9342C-TPN** task planner for test automation
- N9342C-SEC** user data sanitation for security purpose
- N9342C-UK6** commercial calibration certificate with test data included
- N9342C-GPA** external GPS antenna, SMA-M connector
- N9342C-1DN** automotive 12V DC charger
- N9342C-ADP** spare AC/DC adaptor
- N9342C-BCG** external battery charge
- N9342C-SCC** ergonomic soft carrying case with backpack and shoulder strap
- N9342C-TAD** adaptor Type-N(m) 50 Ω to Type-N(f) 75 Ω DC to 1 GHz
- N9342C-1DC** automotive 12V DC adaptor
- N9342C-1TC** hard transit case
- N9342C-BAT** spare battery pack

Warranty and service

Standard warranty is one year

R-51B-001-3C 1 year return-to-Agilent warranty extended to 3 years

Calibration (Options not available in all countries)

R-50C-011-3 inclusive calibration plan, 3 year coverage

R-50C-013-3 inclusive calibration plan and cal data, 3 year coverage

Web Link

www.agilent.com/find/hsa

11970
11974
11867A
N9355
N9356
11852B
U1818
85024A
87405
11945A
11947A
11909A

- Selection of preselected and unpreselected harmonic mixers
- Low conversion loss
- Individually amplitude calibrated
- No bias or tuning adjustments
- High safe input level (100 mW)

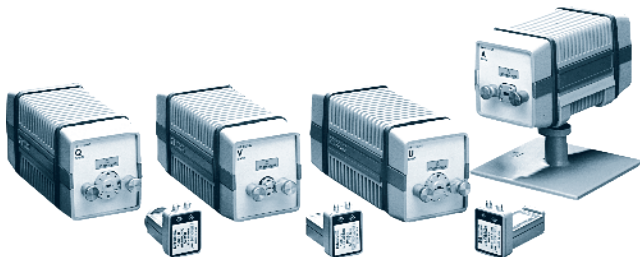

11970, 11974 Series mixers

11970 Series Harmonic Mixers

The 11970 Series waveguide mixers employ a dual-diode design to achieve flat frequency response and low conversion loss without requiring external DC bias or tuning stubs. Small, light, and easy-to-set up, these unpreselected mixers extend the frequency of a variety of spectrum analyzers up to 110 GHz.

Compatible spectrum analyzers include the PSA (E4440A/46A/47A/48A) and the ESA (E4407B) with the external mixing option installed and the 856xEC in which external mixing is a standard feature. The signal identification feature available in those spectrum analyzers helps to easily locate the true signal from its images.

11970 Series harmonic mixers are available in six bands

Agilent model	Frequency range (GHz)	LO harm number	Conversion loss (dB)	Noise level (dB) 1 kHz RBW	Freq. ¹ response (dB)	Gain compression (dBm)
11970K	18 to 26.5	6+	24	-105	±1.9	-3
11970A	26.5 to 40	8+	26	-102	±1.9	-5
11970Q	33 to 50	10+	28	-101	±1.9	-7
11970U	40 to 60	10+	28	-101	±1.9	-7
11970V	50 to 75	14+	40	-92	±2.1	-3
11970W	75 to 110	18+	47	-85	±3.0	-1

¹ Frequency response of the mixers is reduced by 1 dB for LO range of 14 to 18 dBm

11974 Series Preselected Millimeter Wave Mixers

Eliminate the need for signal identification at millimeter frequencies. The Agilent 11974 Series mixers are preselected from 26.5 to 75 GHz. Preselection reduces mixer overload from broadband signals and decreases radiation of local oscillator harmonics back to the device-under-test. These mixers are particularly useful for broadband millimeter signal analysis, millimeter EMI tests, and unattended millimeter wave signal monitoring.

Compatible spectrum analyzers include the PSA (E4440A/46A/47A/48A) and ESA (E4407B) with the external mixing option installed and the 856xEC in which external mixing is a standard feature.

11974 Series preselected mixers are available in four bands

Agilent model	Frequency range (GHz)	Sensitivity ¹ (displayed avg. noise level/10 Hz) (dBm)	Calibration accuracy ¹ (dB)	Image rejection ¹ (dB)	1 dB gain compression (dBm)
11974A	26.5 to 40	-111	< ±2.3	-54	+6
11974Q	33 to 50	-106	< ±2.3	-50	+0
11974U	40 to 60	-109	< ±2.6	-50	+0
11974V	50 to 75	-100	< ±4.5	-40	+3

¹ Specifications apply when connected to the PSA Series spectrum analyzers

11867A and N9355/56 Series Limiters

Protect spectrum/signal analyzer and other instrument input circuits from high power levels with minimal effect on measurement performance. The 11867A RF limiter (DC to 1.8 GHz) reflects signals up to 10 W average power and 100 W peak power. The N9355/56 Series limiters cover frequency ranges from 10 MHz to 18 GHz (N9355B/56B), to 26.5 GHz (N9355C/56C), and to 50 GHz (N9355F) with low insertion loss. The typical limiting threshold for the N9355 limiters is 10 dBm and for the N9356 it is 25 dBm.

11852B Impedance Matching Adapter

Impedance matching adapters are instrument-grade tools used in RF and microwave signal matching that adapt 50 to 75 Ω impedance, or vice versa. The 11852B minimum loss adapter is an impedance converter with Type-N connector, operating from DC to 3 GHz.

U1818A/B Differential Probes (100 kHz to 7 or 14 GHz)

In-circuit measurements are made easy with the Agilent U1818 Series active differential probes covering up to 14 GHz. Excellent flatness (±5 dB) across broad bandwidth and low noise floor (-130 dBm) ensures high measurement accuracy and wide dynamic range.

85024A Probe (300 kHz to 3 GHz)

With input capacitance of 0.7 pF shunted by 1 MΩ resistance, this probe allows high frequency (up to 3 GHz) probing without adverse loading of the circuit under test.

87405B/C Preamplifiers

Agilent 87405B/C preamplifiers operate from frequencies as low as 100 MHz up to 18 GHz. With convenient probe-power bias, the 87405B/C preamplifiers easily work with a variety of Agilent signal/spectrum analyzers, such as the X-Series, PSA and ESA, improving overall system performance and helping reduce system errors with reliable gain and low noise figure.

11945A Close Field Probe Set with 11940 and 11941 Close-Field Probes

The 11940A (30 MHz to 1 GHz) and the 11941A (9 kHz to 30 MHz) are calibrated in dBμA/m and are designed to measure the magnetic field generated by currents. The probes have a high level of electric field rejection. Each probe is calibrated and comes with a 2 meter RG223 coaxial cable, an SMA(f) to Type "N"(m) adapter, and an SMA(f) to BNC(m) adapter. 11945A Option E51 adds an 11909A preamplifier.

11947A Transient Limiter

The transient limiter protects the RF input of signal analyzers from high level transients. The 11947A transient limiter is recommended to be used with line impedance stabilization networks.

11909A Preamplifier

The preamplifier has a frequency range of 9 kHz to 1 GHz with a gain of 32 dB and a noise figure of 1.8 dB. The 11909A is recommended for radiated emissions tests and with the 11945A close field probe set.

Web Link

www.agilent.com/find/externalmixers
www.agilent.com/find/rfprobes
www.agilent.com/find/amplifiers

- 5.7-inch color display
- One-button access to analyzer, generator and sweep modes
- Characterize signal-to-noise ratio, SINAD, IMD, DFD, THD+N ratio, THD+N level, crosstalk, and more
- Wide selection of filters
- Low noise level
- Versatile measurement functions



The Agilent U8903A audio analyzer is a scalable, single-unit solution that provides versatile measurement functions, diverse test signals, and powerful analysis capabilities; plus, it comes with industry-standard connectors. At DC and from 10 Hz to 100 kHz, it helps you measure and quantify audio performance in applications such as wireless audio, analog components and ICs, and consumer audio. The U8903A also replaces the widely used HP 8903B audio analyzer.

The U8903A audio analyzer combines the functionality of a distortion meter, SINAD meter, frequency counter, AC voltmeter, DC voltmeter and FFT analyzer with a low-distortion audio source. On the bench or in a test system, its accuracy and versatility will help you make an audible difference in your end product.

Measure and Analyze Essential Audio Parameters

With the U8903A, you can measure below, across and above the audio spectrum with its 10 Hz to 100 kHz frequency range and built-in DC measurements. Its dual input channels let you perform stereo audio, frequency response, wireless and component tests – all at a single-channel price.

Easily characterize parameters such as signal-to-noise ratio, SINAD, intermodulation distortion (IMD), different-frequency distortion (DFD), total harmonic distortion (THD+N ratio, THD+N level), crosstalk and more. Additional measurement capabilities include AC level, DC level, frequency count and frequency spectrum.

For all measurements, you can apply weighting functions as well as low-pass, high-pass and standard filters. You can also create custom filters using MATLAB and other applications and upload them through the analyzer's USB port. Filters and weighting functions can be applied one, two or three at a time.

Generate High-Quality Test Signals

The built-in, dual-channel signal generator lets you stimulate your device with a variety of high-quality signals: sine (–105 dB noise floor), square, rectangular, noise (Gaussian and Rectangular), two-tone and multi-tone (up to 60). To simulate complex and real-world signals, you can also create arbitrary waveforms with up to 16,384 points and a 321.5 kHz sampling rate.

The output voltage range is 0 V to 8 Vrms with 1% accuracy. For unbalanced connections, you can select 50 W or 600 W output impedance.

Source

Connectors

- Balanced output: XLR
- Output impedance: 100 Ω , 600 Ω
- Unbalanced output: BNC
- Output impedance: 50 Ω , 600 Ω

Sine

- Frequency range: 5 Hz to 80 kHz
- Frequency accuracy: 5 ppm (0.0005%)
- Voltage range (balanced output): 0 V to 16 Vrms
- Voltage range (unbalance output): 0 V to 8 Vrms
- Voltage accuracy: $\pm 1\%$
- Flatness: ± 0.01 dB, 20 Hz to 20 kHz
- THD+N at 1 kHz, 1 Vrms: ≤ -95 dB, 20 Hz to 20 kHz

Includes dual-sine, multi-tone (up to 60), inter-modulation distortion (IMD), different frequency distortion (DFD), arbitrary waveform, and noise generation (Gaussian and Rectangular PDF) capabilities.

Analyzer

Connectors

- Balanced output: XLR
- Input impedance: 200 k Ω
- Unbalanced output: BNC
- Input impedance: 100 k Ω

Detector

- Level detectors: RMS, Quasi-peak, Peak-to-peak

Frequency

- Frequency range: DC/10 Hz to 100 kHz
- Frequency accuracy: 5 ppm (0.0005%)

Voltage

- AC measurement range: < 1 μ V to 140 Vrms
- AC voltage range: 400 mV to 140 Vrms
- AC accuracy (20 Hz to 20 kHz): $\pm 1\%$
- DC measurement range: 0 to ± 200 V
- DC accuracy: $\pm 1\%$
- Flatness: ± 0.01 dB, 20 Hz to 20 kHz

THD+N/SINAD

- Fundamental frequency range: 10 Hz to 100 kHz
- THD+N at 1 kHz, 1 Vrms: ≤ -101 dB, 20 Hz to 20 kHz

Other measurements

- CMRR, Cross Talk, Phase, SNR, Sweep capabilities

Filters

Standard filters

- Low pass filters: 15 kHz, 20 kHz, 30 kHz
- High pass filters: 22 Hz, 100 Hz, 400 Hz

Weighting filters

- A weighting, C-Message, CCIR-1K, CCIR-2K, CCITT

User defined filters

- Users can define their own filters using software and upload them to the analyzer through USB, GPIB or LAN interfaces

FFT analyzer

- Frequency range: DC to 100 kHz
- FFT size: Up to 32768 points
- Windows functions: Rectangular, Hann, Blackman-Harris, Rife-Vincent 1 and 3, Hamming, Flattop

Web Link

www.agilent.com/find/audioanalyzer

This table contains recommended replacements for the discontinued signal/spectrum analyzer products.

For more detailed information regarding replacement performance please see the pages listed below.

Discontinued product	Recommended replacement products	Options	Page
8566A/B spectrum analyzer, 100 Hz to 22 GHz	N9030A PXA or N9020A MXA	Option 526	PXA: 49 MXA: 52
8568A/B spectrum analyzer, 100 Hz to 1.5 GHz	N9030A PXA or N9020A MXA	Option 503	PXA: 49 MXA: 52
8560E/EC spectrum analyzer, 30 Hz to 2.9 GHz	N9020A MXA or N9030A PXA	Option 503	PXA: 49 MXA: 52
8561E/EC spectrum analyzer, 30 Hz to 6.5 GHz	N9020A MXA or N9030A PXA	Option 508	PXA: 49 MXA: 52
8562E/EC spectrum analyzer, 30 Hz to 13.2 GHz	N9020A MXA or N9030A PXA	Option 513	PXA: 49 MXA: 52
8563E/EC spectrum analyzer, 30 Hz to 26.5 GHz	N9020A MXA or N9030A PXA	Option 526	PXA: 49 MXA: 52
8590A spectrum analyzer, 10 kHz to 1.5 GHz	N9000A CXA or N9010A EXA	Option 503	CXA: 56 EXA: 54
8590B spectrum analyzer, 9 kHz to 1.8 GHz	N9000A CXA or N9010A EXA	Option 503	CXA: 56 EXA: 54
8591E portable spectrum analyzer, 9 kHz to 1.8 GHz	N9000A CXA or N9010A EXA	Options 503, PRC	CXA: 56 EXA: 54
8591EM EMC analyzer, 9 kHz to 1.8 GHz	N9000A CXA or N9010A EXA	Options 503, W6141A (for CXA) or N6141A (for EXA)	CXA: 56 EXA: 54
8592L portable spectrum analyzer, 9 kHz to 22/26.5 GHz	N9010A EXA	Options 526, PRC	54
8593E portable spectrum analyzer, 9 kHz to 22 GHz	N9010A EXA	Options 526, PRC	54
8593EM EMC analyzer, 9 kHz to 22 GHz	N9010A EXA	Options 526, N6141A	54
8594E portable spectrum analyzer, 9 kHz to 2.9 GHz	N9000A CXA or N9010A EXA	Options 503, PRC	CXA: 56 EXA: 54
8594L portable spectrum analyzer, 9 kHz to 2.9 GHz	N9000A CXA or N9010A EXA	Options 503, PRC	CXA: 56 EXA: 54
8594EM EMC analyzer, 9 kHz to 2.9 GHz	N9000A CXA or N9010A EXA	Options 503, W6141A (for CXA) or N6141A (for EXA)	CXA: 56 EXA: 54
8594Q QAM analyzer, 9 kHz to 2.9 GHz	N9000A CXA or N9010A EXA	Option 503, W9064A VXA (for CXA) or N9064A VXA (for EXA)	CXA: 56 EXA: 54
8595E portable spectrum analyzer, 9 kHz to 6.5 GHz	N9000A CXA or N9010A EXA	Options 507, PRC	CXA: 56 EXA: 54
8595EM EMC analyzer, 9 kHz to 6.5 GHz	N9000A CXA or N9010A EXA	Options 507, W6141A (for CXA) or N6141A (for EXA)	CXA: 56 EXA: 54
8596E portable spectrum analyzer, 9 kHz to 12.8 GHz	N9010A EXA	Options 513, PRC	54
8596EM EMC analyzer, 9 kHz to 12.8 GHz	N9010A EXA	Options 513, N6141A	54
89441A VSA, DC to 2.65 GHz	89600B VSA		61
89610S VXI-based baseband vector signal analyzer	N9020A MXA	Options BBA, 89600B	52
89640S VXI-based 2.7 GHz RF vector signal analyzer	N9020A MXA or N9010A EXA	Options 503, B25, 89600B	MXA: 52 EXA: 54
89641S VXI-based 6.0 GHz RF vector signal analyzer	N9020A MXA or N9010A EXA	Options 508 (MXA) or 507 (EXA), B25, 89600B	MXA: 52 EXA: 54
E4401B ESA-E spectrum analyzer, 9 kHz to 1.5 GHz	N9010A EXA	Option 503	54
E4411A ESA-L portable spectrum analyzer, 9 kHz to 1.5 GHz	N9000A CXA	Option 503	56
E4406A VSA transmitter tester, 7 MHz to 4 GHz	N9020A MXA or N9010A EXA	Option 508 (MXA) or 507 (EXA)	MXA: 52 EXA: 54
N9320A RF spectrum analyzer, 9 kHz to 3 GHz	N9320B		69
N9340A handheld spectrum analyzer, 100 kHz to 3 GHz	N9340B or N9342C HSA		70
8902A measuring receiver	N5531S		64
8903A audio analyzer	U8903A		73

- **Measurement expertise:** benefit from the Agilent 89601A VSA software to characterize complex, time-varying signals with detailed and simultaneous spectrum, modulation and time waveform analysis
- **Simple:** single vendor solution facilitates integration and simplifies technical support
- **Open standard:** modular and software-defined building blocks provide flexible system configurations to meet diverse test needs. Connector compatibility allows easy integration with other test and automation modules in PXIe Hybrid chassis
- **Fast:** reduced development time enabled with included drivers, soft front panels and programming examples in LabVIEW, LabWindows/CVI, Visual Studio.NET (C/C++, C#, VB.NET), and MATLAB

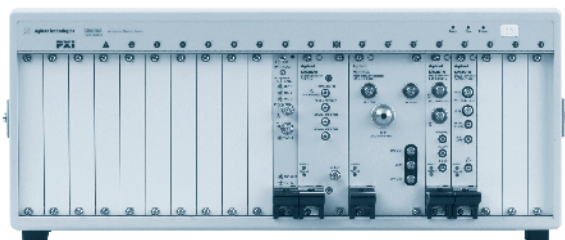

M9392A PXI Vector Signal Analyzer

The Agilent M9392A is a PXI vector signal analyzer with frequency coverage from 50 MHz to 26.5 GHz with 250 MHz of instantaneous bandwidth. When combined with the Agilent 89601A VSA software, the M9392A provides a complete microwave vector signal analyzer solution, enabling analysis of communications, radar, and avionics signals in a modular, open-system standard. The M9392A PXI VSA system consists of the M9202A PXIe IF digitizer, M9302A PXI local oscillator, M9360A PXI attenuator/preselector, and the M9361A and M9351A PXI downconverter modules.

Specifications

- Frequency range from 50 MHz to 26.5 GHz
- Measure broadband (250 MHz) communications and radar signals with 12-bit, 2 GS/s digitizer
- 7 or 8 slot-wide multiple modules

Ordering Information

M9392A PXI vector signal analyzer

Optional module

M9351A PXI downconverter: 50 MHz – 2.9 GHz

Related products

89601A VSA software

M9302A PXI local oscillator: 3 – 10 GHz

M9202A PXIe IF digitizer: 12-bit, 2 GS/s

M9360A PXI attenuator/preselector: 100 kHz – 26.5 GHz

M9351A PXI downconverter: 50 MHz – 2.9 GHz

M9361A PXI downconverter: 2.75 – 26.5 GHz

Web Link

www.agilent.com/find/pxi

www.agilent.com/find/modular

www.agilent.com/find/M9392A

- **Frequency range:** 2.75 to 26.5 GHz
- **Aux input/switch** for signal routing
- **Multiple programmatic interfaces** enable easy integration into existing test environments

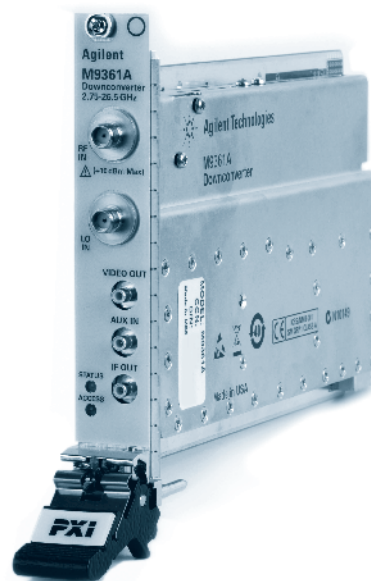

M9361A PXI Downconverter: 2.75 to 26.5 GHz

The Agilent M9361A is a one-slot 3U PXI downconverter that converts microwave signals from 2.75 to 26.5 GHz into baseband frequency signals centered at an IF frequency of 500 MHz. The built-in pre-amp enables very low level signal measurements and built-in calibration simplifies system power budget calculations.

Specifications

- 250 MHz bandwidth
- PXI: 1-slot 3U
- Operating range: –160 to –30 dBm (nominal)

Ordering Information

M9361A PXI downconverter 2.75 to 26.5 GHz

Related products

M9302A PXI local oscillator: 3 – 10 GHz

M9202A PXIe IF digitizer: 12-bit, 2 GS/s

M9360A PXI attenuator/preselector: 100 kHz – 26.5 GHz

M9351A PXI downconverter: 50 MHz – 2.9 GHz

M9392A PXI vector signal analyzer: 50 MHz – 26.5 GHz

Web Link

www.agilent.com/find/pxi

www.agilent.com/find/modular

www.agilent.com/find/M9361A

M9392A
M9351A
M9361A
M9360A
M9302A
M9202A

PXI Downconverter and PXI Local Oscillator

76 M9351A PXI Downconverter: 50 MHz to 2.9 GHz and M9302A PXI Local Oscillator: 3 to 10 GHz

M9392A
M9351A
M9361A
M9360A
M9302A
M9202A

- Frequency range: 50 MHz to 2.9 GHz
- Multiple programmatic interfaces enable easy integration into existing test environments
- Built-in pre-amp for low-level measurements
- Image protected version – no need for a preselector

- Frequency range: 3 to 10 GHz
- Multiple programmatic interfaces enable easy integration into existing test environments
- < 0.1 Hz tuning resolution for greater frequency accuracy

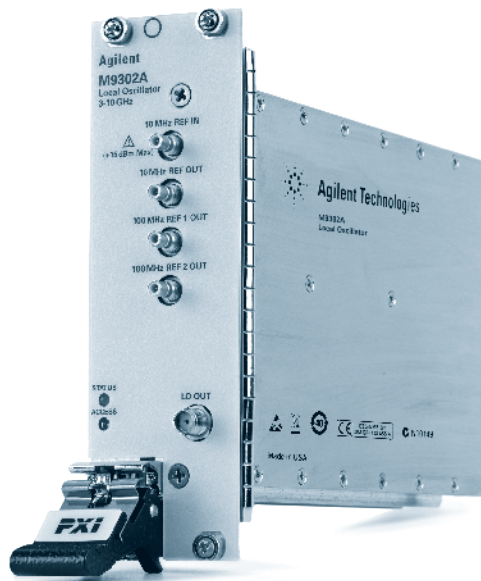
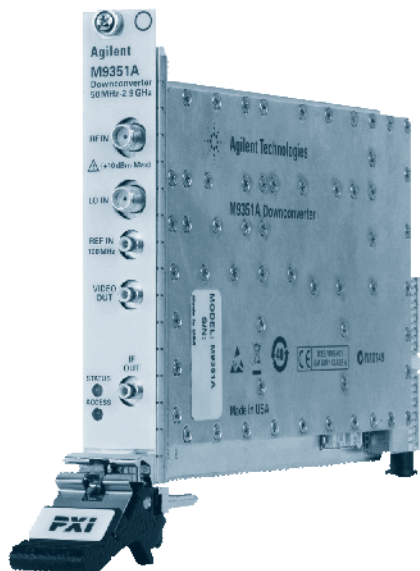

M9351A PXI Downconverter: 50 MHz to 2.9 GHz

The Agilent M9351A PXI downconverter converts RF signals from 50 MHz to 2.9 GHz into baseband frequency signals for use with Agilent's newest generation of PXI digitizers. The built-in pre-amp enables very low level signal measurements, and a built-in calibration simplifies system power budget calculations.

Specifications

- 40 MHz bandwidth
- PXI: 1-slot 3U
- Operating range: -160 to -30 dBm (nominal)

Ordering Information

M9351A PXI downconverter: 50 MHz to 2.9 GHz

Related products

M9302A PXI local oscillator: 3 – 10 GHz
M9202A PXIe IF digitizer: 12-bit, 2 GS/s
M9360A PXI attenuator/preselector: 100 kHz – 26.5 GHz
M9361A PXI downconverter: 2.75 MHz – 26.5 GHz
M9392A PXI vector signal analyzer: 50 MHz – 26.5 GHz

Web Link

www.agilent.com/find/pxi
www.agilent.com/find/modular
www.agilent.com/find/M9351A

M9302A PXI Local Oscillator: 3 to 10 GHz

The Agilent M9302A PXI local oscillator (LO) is a VCO-based 3 to 10 GHz LO optimized for fast settling time to allow for fast frequency down conversion applications. The fast switching time and low phase noise of this LO make it an ideal component of a microwave vector signal analyzer.

Specifications

- PXI: 2-slot 3U
- Frequency temperature stability ± 0.5 ppm (over 0 to 50 deg C)

Ordering Information

M9302A PXI local oscillator: 3 to 10 GHz

Related products

M9202A PXIe IF digitizer: 12-bit, 2 GS/s
M9360A PXI attenuator/preselector: 100 kHz – 26.5 GHz
M9361A PXI downconverter: 2.75 MHz – 26.5 GHz
M9351A PXI downconverter: 50 MHz – 2.9 GHz
M9392A PXI vector signal analyzer: 50 MHz – 26.5 GHz

Web Link

www.agilent.com/find/pxi
www.agilent.com/find/modular
www.agilent.com/find/M9302A

PXI Attenuator/Preselector and M9202A PXIe IF Digitizer

M9360A PXI Attenuator/Preselector: 100 kHz to 26.5 GHz and M9202A PXIe IF Digitizer: 12 bit, 2 GS/s

77

- Frequency range: 100 kHz to 26.5 GHz
- Automatically routes signals around the band limited preselector for additional bandwidth
- Analyze large bandwidth signals



- Digital down-conversion algorithm (DDC) for improved signal to noise ratio
- On-board digital processing capability
- PCIe x4 connectivity for high data throughput



M9392A
M9351A
M9361A
M9360A
M9302A
M9202A

M9360A PXI Attenuator/Preselector: 100 kHz to 26.5 GHz

The Agilent M9360A PXI attenuator/preselector is a 2-slot, 3U, combination module providing attenuation and preselection signal conditioning for numerous system applications. The electronically tuneable, YIG-tuned filter based RF-input pre-selector and the broadband switches for signal distribution provide performance to satisfy even the most demanding spectrum analysis applications.

Specifications

- PXI: 2-slot, 3U
- 3 dB bandwidth: 40 MHz min, 120 MHz max
- 70 dB step attenuator

Ordering Information

M9360A PXI attenuator/preselector: 100 kHz to 26.5 GHz

Related products

M9202A PXIe IF digitizer: 12-bit, 2 GS/s
M9302A PXI local oscillator: 3 – 10 GHz
M9361A PXI downconverter: 2.75 MHz – 26.5 GHz
M9351A PXI downconverter: 50 MHz – 2.9 GHz
M9392A PXI vector signal analyzer: 50 MHz – 26.5 GHz

Web Link

www.agilent.com/find/pxi
www.agilent.com/find/modular
www.agilent.com/find/M9360A

M9202A PXIe IF Digitizer: 12 bit, 2 GS/s

The M9202A PXIe IF digitizer is a wideband IF digitizer with on-board processing capabilities and high throughput capable of digitizing broadband IF frequencies from 200 to 600 MHz.

Specifications

- Resolution: 12 bit
- Sample rate: 2 GS/s
- Bandwidth: 1 GHz
- Data throughput: 1 GB/s

Ordering Information

M9202A PXIe IF digitizer: 12 bit, 2 GS/s

Related products

M9302A PXI local oscillator: 3 – 10 GHz
M9360A PXI attenuator/preselector: 100 kHz – 26.5 GHz
M9361A PXI downconverter: 2.75 MHz – 26.5 GHz
M9351A PXI downconverter: 50 MHz – 2.9 GHz
M9392A PXI vector signal analyzer: 50 MHz – 26.5 GHz

Web Link

www.agilent.com/find/pxi
www.agilent.com/find/modular
www.agilent.com/find/M9202A

3

N8201A
N8211A
N8212A
N8221A
N8241A
N8242A

- Flexible, reconfigurable, modular measurement instrumentation
- Reduces the lifetime cost of ownership of automated test systems
- The highest RF/MW performance synthetic instruments in the industry
- Provides the smallest footprint for automated test systems
- LXI interface provides computer interface longevity



RackSynthetic

3

Synthetic Instrumentation

The synthetic instrument concept breaks the measurement instrumentation down into its most basic functional components, and uses these basic synthetic instrumentation modules as building blocks for synthesizing a variety of different measurements. Different software modules are then used to make many different measurement functions from a few common hardware modules. An RF/microwave synthetic instrument is comprised of three basic functional modules: a frequency converter, a data converter, and a numeric processor. Using these three functional modules, any type of signal can be generated or analyzed.

Extend Longevity and Lower Lifetime Costs

The synthetic instrument concept involves linking individual hardware and software test modules together to emulate standard instruments in a new, compact form factor. The result is an adaptable, common system architecture that enables the military and defense prime contractors to design scalable automated test systems (ATS), giving them the flexibility to insert future technology and transform the ATS to accommodate future new measurement applications. The synthetic instruments provide an economic benefit of extending the useful lifetime of automated test systems, as well as greatly reducing the total lifetime costs associated with these automated test systems.

Highest Performance Synthetic Instruments

Agilent's synthetic instruments offer the highest performing RF/microwave LAN-based modular instrumentation available in the industry. Performance, accuracy, and reliability of the test equipment are required to provide the best assurance of military system readiness. Agilent's synthetic instruments offer the high performance of traditional instrumentation in a synthetic instrument format. When it comes to military test systems, Agilent meets your needs with synthetic instrument modules that have the high performance required by these demanding automated test system applications.

Specifications

N8201A performance downconverter

- Frequency range of 3 Hz to 26.5 GHz, extendable to 110 GHz
- Three IF output frequencies of 7.5, 21.4, and 321.4 MHz
- Amplitude input range: -70 to +30 dBm

N8211A performance analog upconverter

- A high performance 20 or 40 GHz analog microwave source
- Internal or external AM, FM, or pulse modulation
- Multi-source coherent carrier capability

N8212A performance vector upconverter

- A high performance 20 GHz vector microwave source
- > 1 GHz I/Q vector modulation capability
- Internal or external AM, FM, or pulse modulation
- Multi-source coherent carrier capability

N8221A IF digitizer

- Digitizes a 7.5 MHz IF signal with 30 MSA/s sample rate
- 10 MHz modulation bandwidth
- 80 dB of dynamic range; 14 bits of vertical resolution

N8241A 15-bit arbitrary waveform generator

- High-performance arbitrary waveform generator for creating complex wideband waveforms
- 15 bits of vertical resolution with either a 1.25 GSA/s or 625 MSA/s sampling rate and 1.25 Gs/s
- ≤ -65 dBc spurious free dynamic range
- Corresponding instantaneous analog bandwidths of either 500 MHz or 250 MHz per channel
- Dual channel, with single-ended and differential outputs
- Sophisticated sequencing engine
- Multiple AWG synchronization capability

N8242A 10-bit arbitrary waveform generator

- High-performance arbitrary waveform generator for creating complex wideband waveforms
- Similar capabilities as the N8241A, but with reduced vertical resolution and dynamic range
- 10 bits of vertical resolution and 1.25 GSA/s
- ≤ -50 dBc spurious free dynamic range

Ordering Information

N8201A performance downconverter

N8211A performance analog upconverter

N8212A performance vector upconverter

N8221A IF digitizer

N8241A 15-bit arbitrary waveform generator

N8242A 10-bit arbitrary waveform generator

Web Link

www.agilent.com/find/synthetic



behavior, such as gain compression and AM-to-PM. They can also measure frequency translation devices by offsetting the receivers for the source stimulus. Additionally, the source can be pulsed to produce pulsed S-parameters.

Network Analyzers

Agilent network analyzers are instruments that measure transfer and/or impedance functions of linear networks through sine-wave testing (see Figure 2). A network analyzer system accomplishes these measurements by configuring its various components around the device-under-test. The first requirement of the measurement system is a sine-wave signal source to stimulate the device-under-test. Since transfer and impedance functions are ratios of various voltages and currents, a means of separating the appropriate signals from the measurement ports of the device-under-test is required. Finally, the network analyzer itself must detect the separated signals, form the desired signal ratios and display the results.

Why Network Analysis?

Characterizing the behavior of linear electrical networks that will be stimulated by arbitrary signals and interfaced with a variety of other networks is a fundamental problem in both synthesis and test processes. For example, the engineer designing a multi-component network must predict with some certainty, from knowledge of the individual components, the final network performance. Similarly, a production manager must know allowable tolerances on the products manufactured and whether the final products meet the specified tolerances. Network analysis offers a solution to these problems through complete description of linear network behavior in the frequency domain. Additionally, some network analyzers offer the capability to transform measurement data, taken in the frequency domain, to the time domain, providing further insight into the behavior of linear networks.

Network analysis accomplishes the description of both active and passive networks by creating a data model of such component parameters as impedances and transfer functions. However, these parameters not only vary as a function of frequency but are also complex variables in that they have both magnitude and phase (see Figure 1). Swept network analyzers measure magnitude and phase (the total complex quantity) as a function of frequency with less difficulty than conventional CW measurements. Impedance and transfer functions then can be displayed conveniently on an internal display, or on peripherals such as a printer.

Thus, network analysis satisfies the engineering need to characterize the behavior of linear networks quickly, accurately, and completely over broad frequency ranges. Agilent Technologies manufactures a full line of scalar network analyzers (magnitude only) and vector network analyzers (both magnitude and phase).

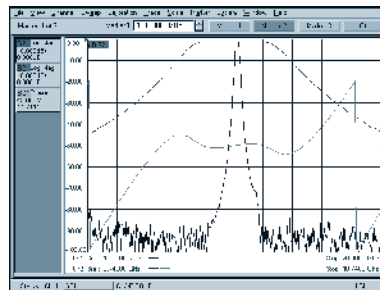

Figure 1: simultaneous wideband and narrowband sweep of a microwave filter, showing magnitude and deviation from linear phase

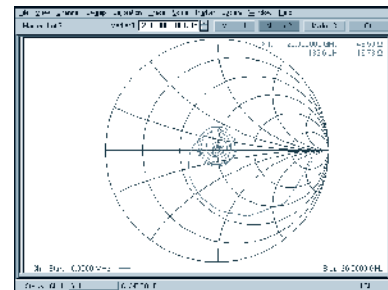

Figure 2: input impedance of a broadband microwave amplifier is read directly with a smith chart display

What is Network Analysis?

Network analysis is the process of creating a data model of the transfer and/or impedance characteristics of a linear network through stimulus-response testing over the frequency range of interest. All network analyzers in the Agilent product line operate according to this definition.

At frequencies above 1 MHz, lumped elements actually become "circuits" consisting of the basic elements plus parasitics like stray capacitance, lead inductance, and unknown absorptive losses. Since parasitics depend on the individual device and its construction, they are almost impossible to predict. Above 1 GHz component geometries are comparable to a signal wavelength, intensifying the variance in circuit behavior due to device construction.

Network analysis has classically been limited to the definition of linear networks. Since linearity constrains networks stimulated by a sine wave to produce a sine-wave output, sine-wave testing is an ideal method for characterizing magnitude and phase response as a function of frequency. Modern network analyzers use sine-wave power sweeps to characterize certain parameters of nonlinear

Signal Sources and Signal Separation

In the general case, any sine-wave source meeting the network analyzer's specifications can be used to stimulate the device-under-test. If the analyzer is capable of swept measurements, great economies in time can be achieved by stimulating the device-under-test with a sweep oscillator or synthesized sweeper. Most Agilent network analyzers contain internal, synthesized sources with excellent frequency resolution. Swept measurements allow quick and easy characterization of devices over broad frequency ranges.

At high frequencies the problem of signal separation usually involves traveling waves on transmission lines and becomes correspondingly more difficult. Agilent network analyzers employ both internal and external test sets applicable for separating the appropriate traveling waves in a variety of high-frequency measurements.

Broadband and Narrowband Detection

After the desired signals have been obtained from the test set, they must be detected by the network analyzer; Agilent network analyzers can use one of two detection methods. Broadband detection accepts the full-frequency spectrum of the input signal, while narrowband detection involves tuned receivers that convert CW or swept-RF signals to a constant-IF signal. There are certain advantages to each detection scheme.

Scalar analyzers usually employ broadband detection techniques. Broadband detection reduces instrument cost by eliminating the IF section required by narrowband analyzers but sacrifices noise and harmonic rejection. However, noise is not a factor in many applications. Finally, broadband systems can make measurements where the input and output signals are not of the same frequency, as in the measurement of the insertion loss of mixers and frequency doublers.

Vector network analyzers normally employ narrowband detection techniques. Narrowband detection makes a more sensitive low noise detection of the constant IF possible. This allows increased accuracy and dynamic range for frequency-selective measurements (as compared to broadband systems).

Vector network analyzers can vary with their employment of broadband, narrowband, or both types of detection. When both types of detection are available, the user selects the detection method, which allows optimization of the device measurements.

Signal Processing and Display

Once the RF has been detected, the network analyzer must process the detected signals and display the measured quantities (see Figure 3). All Agilent network analyzers are multi-channel receivers utilizing a reference channel and at least one test channel; absolute signal levels in the channels, relative signal level (ratios) between the channels, or relative phase difference between channels can be measured, depending on the analyzer.

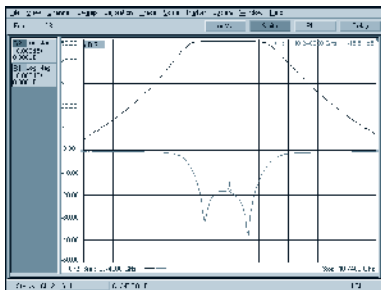

Figure 3: simultaneous measurement of transmission response and passband reflection return loss

Relative ratio measurements are usually made in dB, which is the log ratio of an unknown signal (Test Channel) with a chosen reference signal (Reference Channel). This allows the full dynamic range of the instrumentation to be used in measuring variations of both high- and low-level circuit responses. For example, 0 dB implies the two signal levels have a ratio of unity, while ± 20 dB implies a 10:1 voltage ratio between two signals.

All network analyzer phase measurements are relative measurements with the reference channel signal considered to have zero phase. The analyzer then measures the phase difference of the test channel with respect to the reference channel.

Phase information complements amplitude data in the measurement of device parameters. Phase is more sensitive to network behavior and it is a required component of complex impedance and transfer functions.

Phase data is also required to measure delay distortion or group delay of networks. Delay distortion occurs when different frequency components of a complex waveform experience nonlinear phase shifts as they are transmitted through a network. Group delay (see Figure 4) is a measure of this distortion and is defined as:

$$T_{gd} = -\frac{d\theta}{d\omega}$$

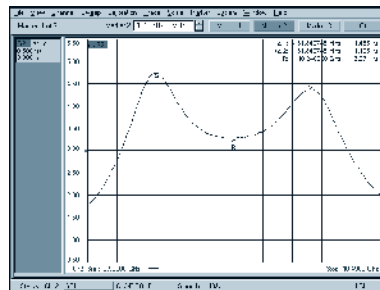

Figure 4: direct measurement of group delay with digital readout at marker

An alternative method for measuring phase distortion is deviation from linear phase or differential phase. Deviations from linear phase can be measured by introducing enough electrical length in the network analyzer's reference channel to linearize a device's phase shift. This is usually accomplished by using the electrical-delay feature of the network analyzer, which cancels the average electrical length of a device mathematically.

Scattering parameters, or S-parameters, were developed to characterize linear networks at high frequencies. S-parameters define the ratios of reflected and transmitted traveling waves measured at the network ports. A two-port device is modeled with S-parameters (see Figure 5). S11 is the complex reflection coefficient at port 1, and is the ratio of b_1/a_1 , if $a_2 = 0$ (port 2 terminated in its characteristic impedance). S21 is the complex transmission coefficient from port 1 to port 2, b_2/a_1 , if $a_2 = 0$. The "a" and "b" signals represent the amplitude and phase of the incident and emerging or reflected traveling waves. By reversing the ports and terminating port 1 in its characteristic impedance, S22 and S12 can be similarly defined.

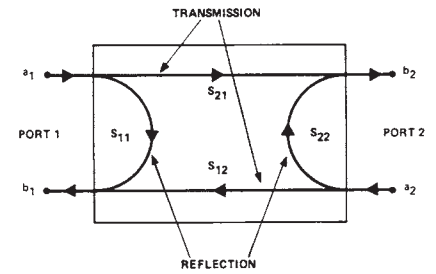

Figure 5: S-parameter model for a two-port linear network

Additional Capabilities

Precision design work and manufacturing tolerances demand highly accurate measurements, but most errors in network measurements are complex quantities that vary as a function of frequency. By characterizing and virtually removing these systematic errors, measurement accuracies are improved by several orders of magnitude. Agilent network analyzers contain built-in, high-speed computational hardware that can perform the complex mathematics required for sophisticated error correction.

Computer-controlled network analyzers can be programmed to set up and make many measurements automatically. The measurement process is further accelerated by the computer's ability to store, transform, summarize, and output data in a variety of formats to a number of peripherals. These capabilities make the computer-controlled network analyzer ideal for both computer-aided design or automatic production testing. Several products have built-in automation features, including GP Instrument BASIC. The PNA family of network analyzers have an integrated Windows operating system. This provides the user with powerful computer control directly in the network analyzer.

- Excellent measurement accuracy
- Fast, precise, integrated synthesized sources
- Choice of integrated S-parameter or T/R test sets
- Advanced automation and flexible options to boost capabilities

Selection Guide for Agilent Network Analyzers

	Frequency range	Number of ports	Balanced measurements*	System impedance	ECal support	Measurement speed (1 sweep, 201 points)
Vector E5100A	10 kHz to 300 MHz	2	No	50 ohm	No	8 ms (1-port cal, ramp-sweep) 64 ms (1-port cal, step-sweep)
Combination network/ spectrum/ impedance 4395A, 4396B	10 Hz to 1.8 GHz	2	No	50 or 75 ohm	No	165 ms (response cal, gain, 30 kHz BW)
Vector – ENA-L E5061A, E5062A	300 kHz to 3 GHz	2	No	50 or 75 ohm	Yes	35 ms (2 port cal, 1 to 1.2 GHz, 30 kHz BW)
Vector – ENA-LF E5061B (Option 3L5)	5 Hz to 3 GHz	2	No	50 ohm	Yes	18 ms (2 port cal, 1 to 1.2 GHz, 300 kHz BW)
Vector – ENA E5071C	9 kHz to 8.5 GHz, 300 kHz to 20 GHz	2 or 4	Yes	50 ohm	Yes	8.8 ms (2 port cal, 1 to 1.2 GHz, 500 kHz BW)
Vector – PNA-L N5230C	300 kHz to 50 GHz	2 or 4	Yes	50 ohm	Yes	18 ms (2-port cal, 1 to 2 GHz, 600 kHz BW)
Vector – PNA E8362/3/4C, E8361C	10 MHz to 67 GHz	2	No	50 ohm	Yes	64 ms (2-port cal, 1 to 2 GHz, 35 kHz BW)
Vector – PNA-X N5241/2/4/5/7A	10 MHz to 67 GHz	2 or 4	Yes	50 ohm	Yes	35 ms (2-port cal, 1 to 2 GHz, 600 kHz BW)
Vector – PNA N5250C	10 MHz to 110 GHz	2	No	50 ohm		

* Table shows the capabilities of the stand-alone instrument. For the PNA, it is possible to add balanced capability with an external test set. Note: For the E5100A, 4395A and 4396B, number of ports denotes for the use with S-parameter test set or T/R test set.

Tackle the Most Demanding Active and Passive Devices

From precision design work to high-volume manufacturing, component test manufactures demand fast, accurate measurements. Agilent offers a host of RF and microwave vector network analyzers that are ready to tackle the most challenging active and passive networks, devices, components and subsystems.

Squeeze more performance from your designs with exceptional accuracy. Wide dynamic range and low trace noise make it easy to see the stopband and passband of even the highest-rejection filters.

On the production line, advanced productivity features such as automated pass/fail testing and segmented sweeps help accelerate test throughput. Built-in programming and connectivity capabilities increase the flexibility of your test systems, and can decrease the cost of test.

ENA-L

The Agilent ENA-L network analyzers provide reliable, basic S-parameter measurements with easy-to-use features and solid performance based on the latest in modern technologies. The transmission/reflection (T/R) test set options offer lower cost solutions, while the S-parameter test set options provide more accurate measurements with full two-port calibration. 75-ohm options, as well as 50 ohm, are available for CATV component measurements.

- 300 kHz to 1.5 GHz – **E5061A**
- 300 kHz to 3 GHz – **E5062A**

ENA-LF

The E5061B network analyzer offers a broad frequency range down to 5 Hz while covering the RF range up to 3 GHz. It supports not only the general RF applications such as filters or amplifiers measurements, but also the LF applications such as loop-gain measurement of DC-DC converters.

- 5 Hz to 3 GHz – **E5061B** (Option 3L5)

ENA

The Agilent ENA network analyzers offer fast and accurate measurements for RF components. Built-in 2 and 4 test ports provide simultaneous measurement of all signal paths for components with up to four ports. The ENA provides built-in balanced measurement

capability, which enables you to test balanced components such as, SAW filters and differential amplifiers. It provides mixed-mode S-parameter measurements with a fixture simulator function.

- 9/100 kHz to 4.5/6.5/8.5 GHz, 300 kHz to 14/20 GHz – **E5071C**

PNA-L Series

Agilent PNA-L network analyzers are designed for your general-purpose network analysis needs and priced for your budget. PNA-L provides efficiency and flexibility in both manufacturing and R&D applications for industries ranging from wireless LAN components to aerospace and defense.

- 300 kHz to 6 GHz – **N5230C (Option 020/025)**
- 300 kHz to 13.5 GHz – **N5230C (Option 120/125)**
- 300 kHz to 20 GHz 4-port – **N5230C (Option 240 or 245)**
- 10 MHz to 20 GHz – **N5230C (Option 220 or 225)**
- 10 MHz to 40 GHz – **N5230C (Option 420 or 425)**
- 10 MHz to 50 GHz – **N5230C (Option 520 or 525)**

PNA-X Series

The Agilent PNA-X is the premier-performance network analyzer for active device test. Exceptional performance, configurability, and an integrated second source enables engineers to stay on the leading edge of component testing.

- 10 MHz to 70 GHz – **N5241/2/4/5/7A**

PNA Series

The Agilent PNA Series microwave vector network analyzers offer an unsurpassed combination of speed and precision to meet the challenges of general-purpose, high-performance and millimeter-wave component testing from 10 MHz to 110 GHz. Frequency-offset capability for the PNA Series microwave network analyzer offers industry-leading accuracy and ease-of-use for non-linear measurements, including mixer and converter test, as well as amplifier IMD and harmonic measurement capability.

- 10 MHz to 20 GHz – **E8362C**
- 10 MHz to 40 GHz – **E8363C**
- 10 MHz to 50 GHz – **E8364C**
- 10 MHz to 67 GHz – **E8361C**
- 10 MHz to 110 GHz – **N5250C**

E5061A
E5062A
E5061B
E5071C
N5230C
E8362C
N5241A
N5242A
N5244A
N5245A
N5247A
E8363C
E8364C
E8361C
N5250C

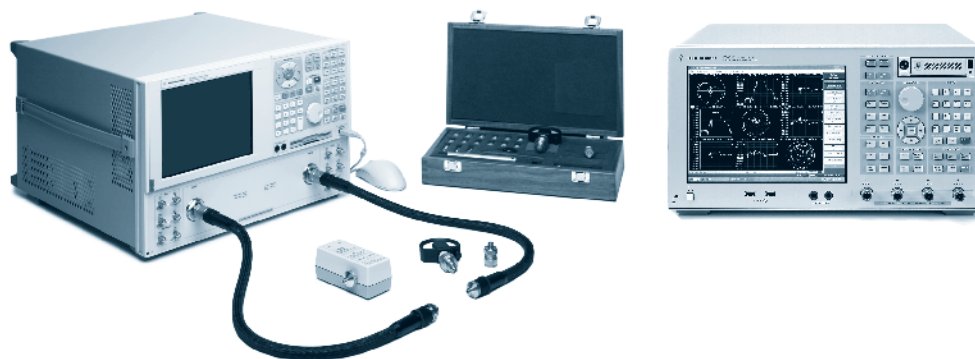

The Agilent 8712ET, 8712ES, 8714ET, 8714ES RF network analyzers were discontinued on June 30, 2004. The Agilent 8719ET, 8719ES, 8720ET, 8720ES, 8722ET and 8722ES microwave network analyzers were discontinued on April 30, 2005. The Agilent 8753ET and 8753ES RF network analyzers were discontinued on October 31, 2006.

Agilent ENA-L, ENA-LF, ENA, PNA-L, PNA-X and PNA Series of network analyzers are the recommended replacement products. ENA and PNA models offer fast and accurate RF component measurements for both R&D evaluations and production testing.

Recommended Replacement Products

Max freq.	Discontinued products	Suggested replacement family	T/R Test Set, 75 Ω	Multiport or balanced/differential	Frequency offset mode for mixers, harmonics and intermodulation	Vector & scalar mixer Cal	Configurable test set	Pulsed RF or antenna test
1.5 GHz	8712ET/ES	300 kHz to 1.5 GHz ENA-L Series	E5061A					
3 GHz	E8356A E8801A N3381A 8753ET/ES 8714ET/ES	300 kHz to 3 GHz ENA-L Series or 5 Hz to 3 GHz ENA-LF or 9/100 kHz to 4.5 GHz ENA Series	E5062A	E5071C (Option 440 or 445)	E5071C (Option 008)	E5071C (Option 008)		
6 GHz	E8357A E8802A N3382A 8753ET/ES (Option 006)	9/100 kHz to 6.5 GHz ENA Series or 300 kHz to 6 GHz PNA-L Series		E5071C (Option 460 or 465)	E5071C (Option 008) N5230C (Option 020 or 025, & 080)	E5071C (Option 008)	N5230C (Option 025)	N5230C (Option 025)
9 GHz	E8358A E8803A N3383A	300 kHz to 13.5 GHz PNA-L Series			N5230C (Option 120 or 125, & 080)		N5230C (Option 125)	N5230C (Option 125)
13.5 GHz	8719ES 8719ET	300 kHz to 13.5 GHz PNA-L Series			N5230C (Option 120 or 125, & 080)		N5230C (Option 125)	N5230C (Option 125)
20 GHz 4-port	8720ES with special test set	10 MHz to 26.5 GHz PNA-X Series		N5230C (Option 240 or 245)	N5230C (Option 240 or 245, & 080)		N5230C (Option 245)	
20/40 GHz	8720/22ES 8720/22ET	10 MHz to 26.5 GHz PNA-X Series			N5230C (Option 220 or 225, 420 or 425, 520 or 525, & 080)	E8362/3/4C (Option 014, UNL, 080, 081, 083)	N5230C (Option 225 or 425 or 525) E8362/3/4C (Option 014)	E8362/3/4C (Option 014, UNL, 080, 081, H11, H08)

Web Link

www.agilent.com/find/nadisco

- **Wide dynamic range:** > 123 dB
- **Low trace noise:** < 0.004 dBrms at 70 kHz IFBW
- **Fast measurement speed:** 41 ms at full 2-port cal, 1601 points
- **Integrated 2, or 4 test ports**
- **Built-in balanced measurements**
- **Fixture embedding/de-embedding**
- **Mixer evaluation with advanced calibration**
- **Easy automation through USB**
- **LXI Class C compliance**
- **4-port electronic calibration kit (ECal) support**
- **Built-in Microsoft Visual Basic for Applications (VBA)**
- **10.4-inch color LCD with touch screen**



E5071C

E5071C ENA Network Analyzers

The Agilent E5071C ENA network analyzer is the ideal solution for manufacturing and R&D engineers evaluating RF components and circuits from 9 kHz to 8.5 GHz, featuring an integrated 2- or 4-port, the highest performance, extended lower frequency range and fastest speed in its class. The ENA significantly reduces cost of test through its ability to cover such a wide frequency range in a single instrument. The ENA addresses a broad array of component and circuit tests including EMC-related applications and automotive, wireless communications, aerospace and defense, education, and medical applications.

De Facto Industry Standard RF Network Analyzer

The ENA is a replacement for the legacy de facto industry standard: Agilent 8753 RF network analyzer. The lower-end frequency is 9 kHz without built-in bias tees and 100 kHz with built-in bias tees. Built-in bias tees and AUX inputs for DC measurements allow the ENA to replace Agilent 8753 in DC-biased measurement applications and amplifier test applications respectively. The built-in probe power also allows active probes to be used without an external probe power supply. In-circuit testing can be done using the high-impedance probe.

Excellent Measurement Accuracy and Speed

The ENA provides exceptional performance with industry-leading dynamic range (123 dB), trace noise (0.004 dBrms at 70 kHz IFBW) and fast measurement speed (39 ms at 1601 points, 2-port full cal). The ENA's measurement capabilities enables the design of high performance components with a short cycle time.

Advanced Architecture for Multipoint Component Test

Built-in 2, or 4 test ports provide simultaneous measurement of all signal paths for components. This advanced architecture minimizes the number of sweeps to complete a multipoint S-parameter measurement and dramatically improves test throughput.

The ENA holds up to 36 measurement channels in a single instrument state. Independent frequency list, calibration data, measurement parameters, trace layout, triggering, and limit test are applied in each measurement channel, which acts as if it is an independent network analyzer. This multi-channel capability eliminates recall time for sequencing multiple instrument setup states. Up to 36 display windows representing each measurement channel may be observed simultaneously. Within each window, it is possible to display up to 9 traces. The layout of display windows and traces are easily selected from the various preset states.

Integrated Balanced Measurement and Embedding/De-Embedding

The ENA provides balanced conversion and delivers mixed mode S-parameter measurements with 4 test ports. This integrated measurement capability improves test efficiency of balanced components.

The matching circuit function (embedding) re-calculates measured data to simulate characteristics of components including matching circuits with arbitrary port characteristic impedance. The de-embedding function removes additional fixture characteristics from the measured data, enabling the measurement of a device's characteristics without the test fixture effects.

Advanced Mixer Measurement Capabilities

The ENA offers the frequency-offset mode (FOM) that provides frequency-offset sweep, external signal source control, and fixed IF/RF measurement capabilities. In addition, the ENA FOM supports two mixer calibration techniques. The first technique is the vector-mixer calibration (VMC) that corrects for directivity, source match, load match, and reflection frequency response at each test port by using a characterized calibration mixer with de-embedding function. This calibration provides the most accurate measurements of phase and absolute group delay. The second is the scalar-mixer calibration (SMC) that offers the highest accuracy conversion loss/gain measurement results while correcting the mismatches of both input and output test ports.

Reducing Calibration Time Using ECal

The ENA provides full 2- and 4-port calibration and improves measurement accuracy of multipoint devices. The ENA supports various electronic calibration kits (ECal), including the N4431B 4-port electronic calibration kit. The ECal automatically performs the calibration procedure and minimizes operational errors. The ECal module can be controlled by the ENA via USB interface without an external PC. The front USB port is available for the ECal module and can easily connect to a rack mounted ENA. The ENA supports various ECal functions. After ECal calibration, performance can be verified using the ECal Confidence Check function. The User-Characterization ECal function enables calibration with various adapters attached, increasing your calibration flexibility.

Evolution of Test Automation, Built-In VBA

The ENA accelerates test system development, expands customization capability and increases flexibility of test system integration. VBA is a powerful programming language that brings in a new era of test automation. A test program can be developed in the ENA by using the built-in VBA editor. This powerful programming tool helps you to accelerate test system development.

A custom user interface can be easily developed with the graphical programming features of the VBA. This allows the limit test results and instructions to be displayed and helps to avoid operational errors.

At times measurement parameters need to be calculated mathematically or processed statistically after data acquisition. The VBA is also useful for such post processing. Unique analysis functions are easily implemented using various VBA functions. This expands analysis capability of the test equipment and fully meets test needs.

E5071C

E5071C
E5092A

Ease-of-Use

The ENA series employs conventional softkey-style operation, which enables users to quickly start using it without any intensive learning. The touch screen provides further enhancement for usability. The large 10.4-inch color display is very useful when looking at many traces for multipoint measurements. For those who are familiar with a Windows PC, the ENA series can also be controlled using Windows-style pull down menus. These easy-to-use features increase engineers' test efficiency.

Key Specifications

Test frequency

- 9 kHz to 4.5/6.5/8.5 GHz (without bias tees)
- 100 kHz to 4.5/6.5/8.5 GHz (with bias tees)
- 300 kHz to 14/20 GHz (with bias tees)

Test port output power

- -55 to +10 dBm

Number of test ports

- 2 or 4

IFBW

- 10 Hz to 500 kHz (1, 1.5, 2, 3, 4, 5, 7 step)

Channel/trace type

- 1/4, 2/4, 4/16, 9/9, 12/6, 16/4, 16/16, 24/12, 36/9

Number of points

- 2 to 20,001 (with only 1 channel/4 traces mode. In other mode, maximum is 1,601)

System dynamic range (4.5/6.5/8.5 GHz options)

- 97 dB (9 to 300 kHz at 10 Hz IFBW)
- 107 dB (300 kHz to 10 MHz at 10 Hz IFBW)
- 123 dB (10 MHz to 6 GHz at 10 Hz IFBW)
- 117 dB (6 to 8.5 GHz at 10 Hz IFBW)

Trace noise (magnitude) (4.5/6.5/8.5 GHz options)

- 0.004 dBrms (9 to 30 kHz at 3 kHz IFBW)
- 0.003 dBrms (30 kHz to 10 MHz at 3 kHz IFBW)
- 0.004 dBrms (10 MHz to 4.38 GHz at 70 kHz IFBW)
- 0.006 dBrms (4.38 to 8.5 GHz at 70 kHz IFBW)

Cycle time

- 41 ms at full 2-port calibration, 1601 points, Start 1 GHz, Stop 1.2 GHz

Stability (magnitude) (4.5/6.5/8.5 GHz options)

- ±0.005 dB/°C (9 kHz to 3 GHz)
- ±0.010 dB/°C (3 to 6 GHz)
- ±0.040 dB/°C (6 to 8.5 GHz)

Ordering Information

E5071C Agilent ENA network analyzer

- E5071C-240** 2-port test set 9 kHz to 4.5 GHz, without bias tees
- E5071C-245** 2-port test set 100 kHz to 4.5 GHz, with bias tees
- E5071C-440** 4-port test set 9 kHz to 4.5 GHz, without bias tees
- E5071C-445** 4-port test set 100 kHz to 4.5 GHz, with bias tees
- E5071C-260** 2-port test set 9 kHz to 6.5 GHz, without bias tees
- E5071C-265** 2-port test set 100 kHz to 6.5 GHz, with bias tees
- E5071C-460** 4-port test set 9 kHz to 6.5 GHz, without bias tees
- E5071C-465** 4-port test set 100 kHz to 6.5 GHz, with bias tees
- E5071C-280** 2-port test set 9 kHz to 8.5 GHz, without bias tees
- E5071C-285** 2-port test set 100 kHz to 8.5 GHz, with bias tees
- E5071C-480** 4-port test set 9 kHz to 8.5 GHz, without bias tees
- E5071C-485** 4-port test set 100 kHz to 8.5 GHz, with bias tees
- E5071C-2D5** 2-port test set 300 kHz to 14 GHz, with bias tees
- E5071C-4D5** 4-port test set 300 kHz to 14 GHz, with bias tees
- E5071C-2K5** 2-port test set 300 kHz to 20 GHz, with bias tees
- E5071C-4K5** 4-port test set 300 kHz to 20 GHz, with bias tees
- E5071C-008** frequency-offset mode
- E5071C-TDR** enhanced time domain analysis capability
- E5071C-010** time domain analysis capability
- E5071C-790** measurement wizard assistant software
- E5071C-1E5** high stability timebase

- Frequency range 50 MHz to 20 GHz
- Up to 10-port full crossbar or maximum 22-port measurement capability
- Extremely fast switching speed optimized for the ENA
- Temperature control function for superior measurement stability
- Internal DC sources for controlling an active multipoint DUT
- Supported by ENA measurement wizard assistant (MWA) software

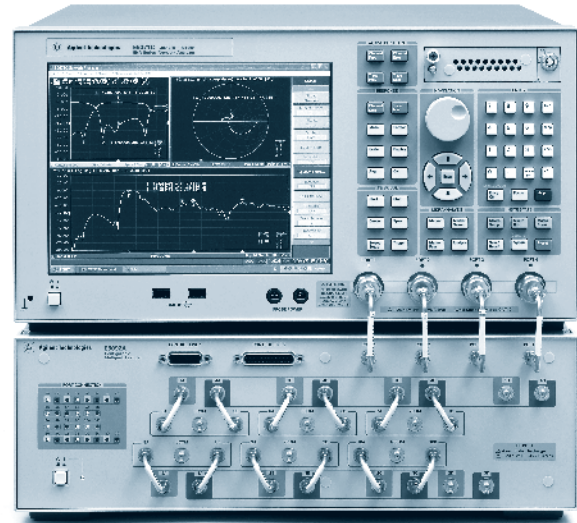

E5092A

E5092A

The E5092A configurable multipoint test set combined with the 4-port ENA network analyzer (E5070B/E5071B/E5071C) with firmware revision A.09.10 or higher, offers a complete multipoint solution up to 20 GHz for a wide range of R&D and manufacturing measurement applications. This powerful combination is suited for testing multipoint devices such as front-end modules (FEM) for cellular handsets, WLAN application or other general-purpose multipoint devices. The test set offers flexible configuration capability that enables customization of switch matrix depending on required applications. The E5092A can be used with the measurement wizard assistant (MWA) software (E5071C-790, E5070B/71B-790) that simplify complex multipoint test setup and increase the efficiency of a test station and measurement productivity.

Ordering Information

E5092A configurable multipoint test set

- E5092A-020** 20 GHz switching test set
- E5092A-08C** cables and adaptors for connection to E5071C-44x/46x/48x
- E5092A-20C** cables and adaptors for connection to E5071C-4D5/4K5

Web Link

- www.agilent.com/find/ena
- www.agilent.com/find/multipoint

- Broad frequency range, from 5 Hz to 3 GHz
- S-parameter test port (5 Hz to 3 GHz, 50 ohm)
- Gain-phase test port with built-in 1 Mohm input (5 Hz to 30 MHz)
- Wide dynamic range down to low frequency
- Built-in DC bias source (up to ± 40 Vdc, max 100 mAdc)

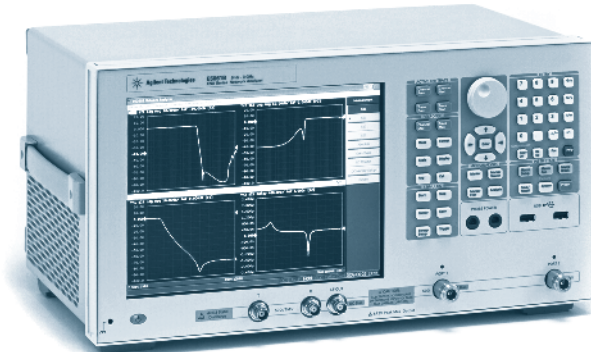

E5061B

The Agilent E5061B Option 3L5 provides versatile high-performance network analysis in a broad frequency range, from 5 Hz to 3 GHz. Providing excellent RF performance that is common to the ENA series, the E5061B also offers full-fledged LF (low frequency) network measurement capabilities; including gain-phase test port with built-in 1 Mohm inputs. The E5061B's comprehensive measurement applications from low to high frequencies include DC-DC converters, PDNs (power distribution networks), and RF devices such as filters and amplifiers.

S-Parameter Measurements from 5 Hz to 3 GHz

The built-in S-parameter test set seamlessly covers from 5 Hz to 3 GHz. This enables you to test a variety of 50 ohm devices including filters, amplifiers, antennas, cables, and EMC devices. Also, full 2-port S-parameter measurement capability down to 5 Hz is useful for semiconductor device characterization in the near-DC range.

High-Impedance Probing Measurements Using Gain-Phase Test Port

The E5061B Option 3L5 is equipped with the gain-phase test port for low-frequency applications that require direct source and receiver access and high-impedance probing. The gain-phase test port enables you to easily perform high-impedance probing measurements for low-frequency amplifiers, and control loop circuits such as DC-DC converters. The test frequency range of the gain-phase test port is 5 Hz to 30 MHz. The input impedance of R and T receivers is switchable to 1 M Ω and 50 Ω .

Comprehensive Solution for PDN Measurements

The E5061B Option 3L5 comprehensively supports frequency-domain evaluations of power distribution networks (PDNs: DC power supply circuits for high-performance LSIs).

- 5 Hz to 3 GHz coverage
- DC-DC converter loop-gain measurement
- Milliohm measurement with gain-phase test port.
- DC biased measurement for ceramic bypass capacitors

Useful Features and Functions

- Time domain/fault location analysis
- VBA programming function
- Equation editor

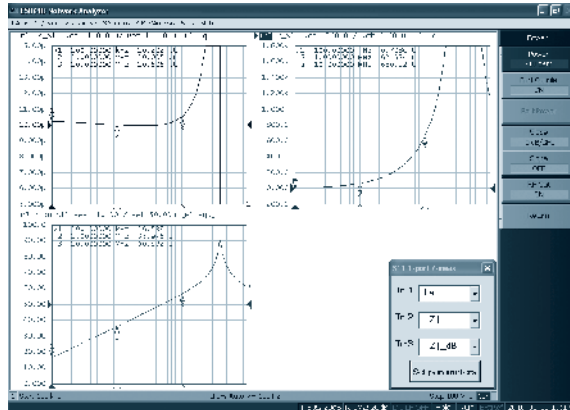

Impedance parameter measurement using VBA macro

Accessories

11667L DC to 2 GHz Power Splitter

The Agilent 11667L is a 50 ohm two-resistor type power splitter with BNC connectors. It is used for 50 ohm transmission measurement with the E5061B's gain-phase test port. The key application is a milliohm PDN impedance measurement in the low frequency range, including DC-DC converters and PCBs populated with bulk bypass capacitors. The 11667L provides excellent amplitude (< 0.2 dB) and phase tracking (± 3), ensures highly accurate power splitting and low SWR minimizes measurement uncertainty.

- Equivalent output SWR: 1.78
- Maximum input power: 0.5 W
- Insertion loss: 6.6 dB
- Tracking between any two ports: < 0.2 dB



11667L power splitter, accessory of E5061B

E5061B
41800A

Specifications

E5061B Option 3L5 Key Specifications¹

- Test frequency range 5 Hz to 3 GHz (1 mHz resolution)
- Frequency stability: 20 ppm (standard), 1 ppm (Option 1E5)
- Test ports:
 - S-parameter test port (5 Hz to 3 GHz, 50 Ω, type-N)
 - Gain-phase test port (5 Hz to 30 MHz, input-Z: 1 MΩ//30 pF and 50 Ω switchable, BNC)
- Source power level: -45 to +10 dBm (power sweep range: 55 dB)
- Dynamic range at S-parameter port (IFBW=10 Hz²):
 - 120 dB (at 1 MHz to 3 GHz), 115 dB (at 100 k to 1 MHz), 110 dB (at 9 k to 100 kHz),
 - 100 dB (at 100 Hz to 9 kHz), 90 dB (at 5 to 100 Hz)
 - 130 dB (at 1 MHz to 3 GHz, S.P.D³)
- Noise level at gain-phase port (IFBW=10 Hz²)
 - Referenced to full scale input level: +15 dBm (ATT=20 dB)/ -5 dBm (ATT=0 dB)
 - -110 dB (at 10 M to 30 MHz), -115 dB (at 100 k to 10 MHz), -105 dB (at 9 k to 100 kHz)
 - -95 dB (at 100 Hz to 9 kHz), -95 dB (at 5 to 100 Hz)
- Trace noise (at IFBW=3 kHz): 5 mdBrms
- Measurement parameter: S11, S21, S12, S22, T/R, absolute values
- DC bias source: 0 to ±40 Vdc, resolution: 1 mV (at 0 to ±10 Vdc) or 4 mV (at ±10 to 40 Vdc)
- DC monitor:
 - Monitors external DC voltage at port R or T
 - Monitors internal DC bias output level at port-1 or LF OUT port.
- Sweep capabilities: Liner/log frequency sweep, segment sweep, power sweep, DC bias sweep
- Number of channels/traces: 4-ch/4-trace
- Number of points: 1601 points
- IFBW: 1 Hz to 300 kHz, manual and auto modes
- Calibration capabilities: response, 1-port full, 2-port full, enhanced response, adapter removal, auto port extension, ECal⁴
- Time domain/fault location: available with the Option E5061B-010. Includes time gating and SRL analysis capabilities.
- Other analysis capabilities: Impedance conversion (reflection, transmission, trans-shunt) limit test functions
- Post data processing: equation editor, VBA

Ordering Information

E5061B network analyzer

E5061B-3L5 LF-RF network analyzer with DC bias source, 5 Hz to 3 GHz

E5061B-1E5 high stability timebase

E5061B-010 time domain/fault location analysis

E5061B-019 2 standard hard disk drive

E5061B-810 add keyboard

E5061B-820 add mouse

E5061B-1CM rack mount kit

E5061B-1CN front handle kit

E5061B-1CP rack mount and front handle kit

E5061B-1A7 ISO 17025 compliant calibration

E5061B-A6J ANSI Z540 compliant calibration



41800A

41800A Active Probe

The 41800A active probe provides high input impedance from 5 Hz to 500 MHz. The 41800A is a valuable tool when used with a network and spectrum analyzer for circuit signal analysis.

Specifications

- Bandwidth: 5 Hz to 500 MHz
- Output connector: 50 Ω type N male
- Input R,C (typical): 100 k Ω, 3 pF (probe alone); 1 MΩ, 1 pF (with 10 : 1, 100 : 1 divider)
- Frequency response relative to 50 MHz: ±1 dB @ 50 Hz to 200 MHz
- Average noise level: 10 nV/√Hz @ ≥ 300 kHz
- Second harmonic distortion: < -50 dBc @ 20 dBm (250 MHz) input (typical)
- Third-order intermodulation distortion: < -70 dBc @ -26 dBm two signal input (typical)
- 1 dB gain compression: > +3 dBm input @ 500 MHz

Web Link

www.agilent.com/find/na_accessories

Web Link

www.agilent.com/find/ena-lf

- 300 kHz to 1.5 GHz (E5061A) or 3 GHz (E5062A)
- T/R or S-parameter test set
- 50 Ω or 75 Ω system impedance
- 10.4-inch color LCD with touch screen
- Affordable, basic performance

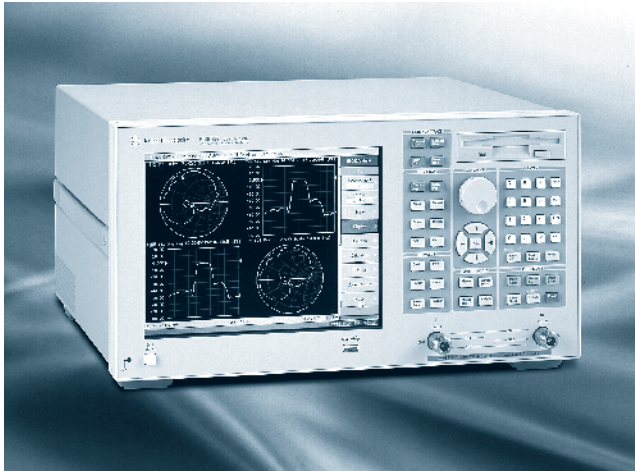

E5062A ENA-L RF network analyzer

Providing the latest in modern technology and flexibility, the Agilent ENA-L network analyzers provide basic vector network analysis in a wide range of industries and applications such as wireless communication, cable TV, automotive, education, and more. Designed to reduce tune and test times, these analyzers provide increased throughput to improve your measurement productivity. The affordably priced ENA-L, equipped with the core functions of the industry-standard ENA, includes many easy-to-use features and is optimized for efficient measurements and high reliability.

Fundamental Performance with Versatile General-purpose Test Capabilities

The ENA-L, with its 120 dB dynamic range and 0.005 dB rms trace noise, provides the accuracy and speed required for many network measurement applications. The wide 30 kHz IF bandwidth (IFBW) and powerful digital processing provide unprecedented measurement speed. The S-parameter test set options offer full two-port calibration for optimum accuracy (Option 250 or 275).

A Variety of Sweep Functions for Effective Analysis

Power sweep and three types of frequency functions provide effective analysis to suit your application needs such as:

- Power sweep to analyze active devices such as amplifiers
- Linear sweep to evaluate narrow-band devices such as filters
- Log sweep to evaluate broadband devices such as cables
- Segment sweep allows you to tailor the sweep condition with up to 201 sweep segments

Optional Electronic Calibration (ECal) Drastically Simplifies Calibration

Unlike the traditional mechanical calibration technique, Agilent's ECal modules only require one set of connections to perform full two-port calibration (controlled through the front panel USB port). The ENA-L controls the ECal module to perform the entire calibration to provide:

- Faster calibration and reduced complexity
- Reduced chance of operator error
- Reduced wear on connectors

Specifications

- Test frequency:
 - 300 kHz to 1.5 GHz (E5061A)
 - 300 kHz to 3 GHz (E5062A)
- Test set: T/R or S-parameter
- Max port output power: 10 dBm
- Port impedance: 50 or 75 Ω
- IFBW: 10 Hz to 30 kHz (1, 3 step)
- Number of points: 2 to 1601
- System dynamic range: 120 dB @ 10 Hz IFBW (1 MHz to 3 GHz)
- Trace noise (magnitude): 0.005 dBrms @ 3 kHz IFBW (1 MHz to 3 GHz)

Ordering Information

E5061A 300 kHz to 1.5 GHz network analyzer

E5062A 300 kHz to 3 GHz network analyzer

E506xA-150 TR test set 50 ohm system impedance

E506xA-175 TR test set 75 ohm system impedance

E506xA-250 S-parameter test set 50 ohm system impedance with extended power range

E506xA-275 S-parameter test set 75 ohm system impedance with extended power range

E506xA-1E1 extended power range (-45 to 10 dBm)

E506xA-100 add fault location and SRL analysis

E506xA-016 touch screen color LCD

Web Link

www.agilent.com/find/ena

E5061A
E5062A

E8362/3/4C
E8361C
N5230C
N5241A
N5242A
N5244A
N5245A
N5247A
N5250C

- Frequency coverage from 300 kHz to 110 GHz
- Highest performance and broadest range of measurement applications
- Electronic calibration (ECal) to 67 GHz
- Open Windows XP operating system

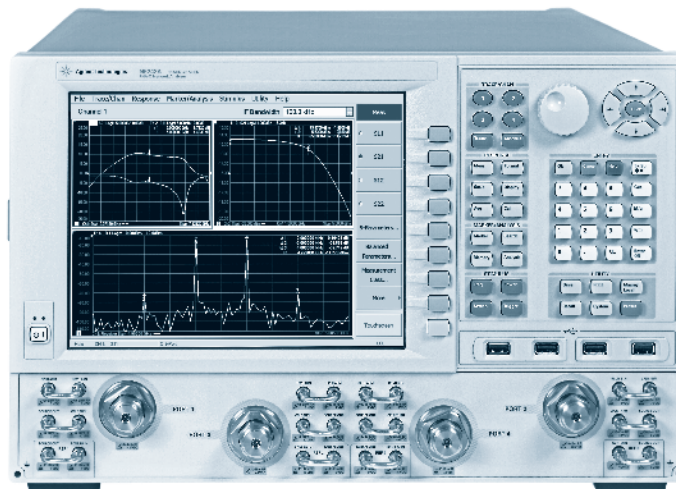

Rapid and continuous changes in RF, microwave, and millimeter-wave technology present a growing challenge for component designers and manufacturers. The Agilent PNA, PNA-X and PNA-L Series of microwave vector network analyzers provides a powerful and flexible measurement platform that meets the challenge with the right combination of high accuracy, fast sweep speeds, wide dynamic range, low trace noise, and enhanced connectivity. The PNA, PNA-X and PNA-L Series will meet your measurement needs now and well into the future.

Common Features

- Electronic calibration for fast, accurate, and convenient system-error correction
- TRL/LRM calibrations for high accuracy fixture and on-wafer measurements
- Configurable test set for a wide variety of measurement setups
- Frequency offset mode for mixer and amplifier-distortion tests
- Time-domain analysis for improved accuracy and filter tuning
- Easy-to-use front-panel hardkey/softkey interface, or use a mouse and pull-down menus
- Extensive built-in help system for quick answers to operation, application, and programming questions
- Open Windows operating systems for advanced automation and easy connection of peripherals

Advanced Connectivity

The PNA family offers many methods of communication to and from the instrument, using a variety of built-in I/O interfaces. Windows XP lets you take advantage of many features you take for granted on your PC, helping you attain a new level of integration for your component-test processes.

For local storage, use the analyzer's internal hard disk drive or connect a USB-based hard disk, flash, or CD-R/W drive. In addition, using drive mapping and the LAN interface, you can save data directly to remote PCs or file servers. This arrangement makes it very easy to develop statistical-process-controlled manufacturing environments.

The PNA family allows a number of ways to connect and control other test equipment such as power meters and signal sources. You can choose to connect them via the USB, GPIB, LAN, serial, or parallel interfaces, and, using any Windows-compatible test program, you can control the test equipment directly from the analyzer. The LAN interface also makes it easy to perform remote troubleshooting. You can view measurement results and control the analyzer from anywhere on the network, whether you are on another floor, in another building, or even at a different site. Additionally, you can download firmware and help-file updates from our web site: www.agilent.com/find/pna

Automation

For manufacturing environments, test automation is essential for high throughput. For R&D, automated tests can save considerable time that might be spent on repetitive and tedious measurements. The PNA family lets you automate your test processes using several powerful automation approaches. You can create programs using familiar SCPI commands via the GPIB or LAN interfaces, or use COM commands over LAN for fast analyzer access and data transfer. Test programs can be executed internally on the PNA or externally on your PC.

Flexibility

In addition to the measurement-hardware flexibility that is achievable using the configurable test set, the PNA's firmware offers unparalleled measurement flexibility as well:

- Configure up to 32 independent measurement channels to eliminate the need for multiple instrument-states recalls
- Use up to 16,001 data points per measurement channel
- Display up to 16 windows, with 4 active traces in each window
- Select up to 10 coupled or independent markers per trace

Throughput

Decreasing test time is often critical for success in manufacturing environments. The PNA family has many attributes that help you accomplish your throughput goals. The outstanding performance of the analyzers starts with exceptionally fast sweeps that do not sacrifice performance. Features such as segmented sweeps and limit lines for pass/fail testing allow you to optimize test efficiency. For devices that once required two to four instrument setups for complete characterization, the PNA Series' ability to have up to thirty-two-measurement channels, each with its own stimulus and response parameters, can also improve your test throughput.

When using Agilent's electronic calibration (ECal) modules, you can dramatically reduce the time it takes to perform calibrations, so you can spend more time measuring your devices. Simply connect the ECal module to your test ports and let the analyzer control and measure all the standards necessary for full two-port calibration. These modules are controlled directly from the analyzer via a USB connection.

PNA-X

The PNA-X is the premier-performance network analyzer for active device test. Exceptional performance, configurability and an integrated second source enable engineers to stay on the leading-edge of component testing.

Key Features

- 2 or 4 port 10 MHz to 67 GHz
- Excellent source output power and harmonic performance
- Built-in signal combiner for IMD measurements
- Built-in pulse generators and modulators for pulse RF measurements
- Banded mm-wave systems to 1 THz
- Compatible with multiport test sets
- Mixed/converter test with advanced calibrations
- Antenna/RCS test

PNA-L Series

The PNA-L Series is a cost-effective solution for general-purpose network-analysis needs. The PNA-L offers the perfect balance of value and performance.

Key Features

- 2-port 300 kHz to 6, 13.5 GHz
- 2-port 10 MHz to 20, 40, 50 GHz
- 4-port 300 kHz to 20 GHz, with mixed-mode S-parameters and advanced fixture corrections
- Frequency and power sweeps for measuring S-parameters and gain compression
- Basic mixer/converter measurements
- Pulsed-RF testing down to 2 μ s pulse widths

PNA Series

The PNA Series provides advanced performance and measurement capabilities, and is specifically designed for more-demanding applications such as high-accuracy mixer/converter test including absolute group delay, and antenna, pulsed-RF, and mm-wave measurements.

Key Features

- 2-port 10 MHz to 20, 40, 50, 67, 110 GHz
- Banded mm-wave systems to 1 THz
- Multiport test sets to 67 GHz
- Mixer/converter test with advanced calibrations
- Antenna/RCS test
- Pulsed-RF testing down to 50 ns pulse widths

Web Link

www.agilent.com/find/na
www.agilent.com/find/pna

E8362/3/4C
 E8361C
 N5230C
 N5241A
 N5242A
 N5244A
 N5245A
 N5247A
 N5250C

E8362/3/4C
E8361C
N5241A
N5242A
N5244A
N5245A
N5247A
N5250C

MW PNA and PNA-X Series

Model	E8362/63/64C	E8361C	N5250C	N5241A	N5242A	N5244A	N5245A	N5247A
Frequency range	10 MHz to 20/40/50 GHz	10 MHz to 67 GHz	10 MHz to 110 GHz ¹	10 MHz to 13.5 GHz	10 MHz to 26.5 GHz	10 MHz to 43.5 GHz	10 MHz to 50 GHz	10 MHz to 67 GHz
Number of ports	2	2	2	—	2 or 4	—	—	—
Connector type (male)	3.5/2.4/2.4 mm	1.85 mm	1.0 mm	3.5 mm	3.5 mm	2.4 mm	2.4 mm	1.85 mm
Dynamic range (at test port)²								
10 to 45 MHz	79 dB	61 dB	63 dB	93 dB	93 dB	74 dB	74 dB	86 dB
45 MHz to 2 GHz	94 to 119 dB	87 to 111 dB	94 to 120 dB	93 to 124 dB	93 to 124 dB	93 to 118 dB	93 to 118 dB	108 to 125 dB
2 to 20 GHz	122 dB	111 dB	111 dB	127 dB	127 dB	118 to 124 dB	118 to 124 dB	124 to 125 dB
20 to 40 GHz	110 dB	104 dB	42 dB	—	—	117 to 124 dB	—	111 to 122 dB
40 to 50 GHz	104 dB	96 dB	84 dB	—	—	—	99 to 118 dB	111 dB
50 to 60 GHz	—	97 dB	80 dB	—	—	—	—	111 dB
60 to 67 GHz	—	94 dB	68 dB	—	—	—	—	107 to 112 dB
67 to 75 GHz	—	—	74 dB	—	—	—	—	—
75 to 80 GHz	—	—	85 dB	—	—	—	—	—
80 to 110 GHz	—	—	87 dB	—	—	—	—	—
Dynamic range (receiver access)²								
10 to 45 MHz	129 dB	99 dB	—	128 dB	128 dB	109 dB	109 dB	88 dB
45 MHz to 2 GHz	132 dB	102 to 125 dB	—	115 to 136 dB	115 to 136 dB	113 to 138 dB	113 to 138 dB	110 to 127 dB
2 to 20 GHz	136 dB	125 dB	—	136 dB	136 dB	130 to 136 dB	130 to 136 dB	126 to 127 dB
20 to 40 GHz	119 dB	115 dB	—	139 dB	—	127 to 134 dB	127 to 134 dB	115 to 126 dB
40 to 50 GHz	111 dB	109 dB	—	—	—	126 dB	107 to 126 dB	111 to 115 dB
50 to 60 GHz	—	107 dB	—	—	—	—	—	111 dB
60 to 67 GHz	—	100 dB	—	—	—	—	—	111 dB
Trace noise (1 kHz IF BW)²								
500 MHz to 50 GHz	< 0.006 dB rms < 0.1 deg rms	< 0.006 dB rms < 0.1 deg rms	—	< 0.003 dB rms < 0.05 deg rms	< 0.003 dB rms < 0.05 deg rms	< 0.004 dB rms < 0.003 deg rms	< 0.004 dB rms < 0.003 deg rms	< 0.001 to < 0.002 dB rms < 0.002 dB rms (0.005 dB rms)
50 to 67 GHz	—	—	—	—	—	—	—	—
Maximum output power²								
10 to 45 MHz	+2 dBm	-9 dBm	-8 dBm	+8 dBm	+8 dBm	+4 dBm	+4 dBm	+12 dBm
45 MHz to 10 GHz	+5 dBm	-3 dBm	-3 dBm	+10 to 13 dBm	+10 to 13 dBm	+8 to 13 dBm	+8 to 13 dBm	+12 dBm
10 to 20 GHz	+3 dBm	-2 dBm	-5 dBm	+13 dBm	+13 dBm	+13 dBm	+13 dBm	+10 to +12 dBm
20 to 40 GHz	-4 dBm	-2 dBm	-10 dBm	+13 to 12 dBm ⁹	+13 to 12 dBm ⁹	+9 to 13 dBm	+9 to 13 dBm	+5 to +10 dBm
40 to 45 GHz	-5 dBm	-7 dBm	-15 dBm	—	—	+9 dBm	+5 to 9 dBm	+12 dBm
45 to 50 GHz	-10 dBm	-1 dBm	-12 dBm	—	—	—	+5 to -8 dBm ⁹	+10 dBm
50 to 60 GHz	—	-3 dBm	-17 dBm	—	—	—	—	+10 to +11 dBm
60 to 67 GHz	—	-5 dBm	-22 dBm	—	—	—	—	+11 dBm
67 to 110 GHz	—	—	-8 dBm	—	—	—	—	(+7 dBm)

Full Band Measurement Speed (35 kHz IF Bandwidth, 201 Points; 100 kHz for N5242A)

Model	Frequency	Cycle time (ms) ³	µs/point	Updates/second
E8362C	10 MHz to 20 GHz	126	627	8
E8363C	10 MHz to 40 GHz	185	920	6
E8364C	10 MHz to 50 GHz	210	1045	5
E8361C	10 MHz to 67 GHz	244	1214	4
N5241/2/4/5/7A	10 MHz to 67 GHz	75	373	13
N5250C ⁵	10 MHz to 110 GHz	500	2488	2

Data Transfer Speed, 32-Bit Binary (ms)⁴

	201 points	16,001 points
COM ⁶	0.4	2
SCPI ⁶	1	30
DCOM ⁷	0.8	7
SCPI over GPIB ⁷	7	435

Web Link
www.agilent.com/find/na
www.agilent.com/find/pna

¹ The PNA Series can also be configured with waveguide mm-wave heads for banded solutions up to 1 THz
² Typical performance below 45 MHz and above 67 GHz. All N5250C numbers are typical
³ Typical performance includes retrace and band-switching times with response calibration. Two-port calibration approximately doubles cycle time
⁴ Typical performance
⁵ 10 kHz IF bandwidth
⁶ Program executed in PNA
⁷ Program executed on an external PC
⁸ Power 24 to 26.5 GHz = +5 dBm
⁹ Power 47 to 50 GHz = -8 dBm

Key Specifications

Option	020, 025	120, 125	220, 225	240, 245	420, 425	520, 525
Frequency range	300 kHz to 6 GHz	300 kHz to 13.5 GHz	10 MHz to 20 GHz	300 kHz to 20 GHz	10 MHz to 40 GHz	10 MHz to 50 GHz
Number of ports	2	2	2	4	2	2
Connector type (male)	3.5 mm	3.5 mm	3.5 mm	3.5 mm	2.4 mm	2.4 mm

Dynamic Range, Two-Port Models (at test port), dB

Option	020	120	220	420	520
300 kHz to 1 MHz	103	103	—	—	—
1 to 10 MHz	113	113	—	—	—
10 to 45 MHz	122	122	103 ¹	89 ¹	89 ¹
45 to 500 MHz	122	122	105	90	90
500 MHz to 2 GHz	122	122	110	110	110
2 to 6 GHz	122	122	110	110	110
6 to 8 GHz	—	120	110	110	110
8 to 9 GHz	—	120	110	100	100
9 to 10.5 GHz	—	116	110	100	100
10.5 to 12.5 GHz	—	111	110	100	100
12.5 to 13.5 GHz	—	109	108	100	100
13.5 to 20 GHz	—	—	108	100	100
20 to 31.25 GHz	—	—	—	95	95
31.25 to 40 GHz	—	—	—	90	90
40 to 50 GHz	—	—	—	—	79

Dynamic Range, Four-Port Model (at test port), dB

Option	240
300 kHz to 10 MHz	111 ¹
10 MHz to 4 GHz	120
4 to 6 GHz	118
6 to 10.5 GHz	115
10.5 to 15 GHz	107
15 to 20 GHz	103

Trace Noise (1 kHz BW), dB rms

Option	020	120	220	240	420	520
300 kHz to 10 MHz	0.012	0.012	—	0.015 ¹	—	—
10 to 45 MHz	0.004	0.004	0.004 ¹	0.006	0.015 ¹	0.015 ¹
45 MHz to 6 GHz	0.004	0.004	0.006	0.001	0.010	0.010
6 to 13.5 GHz	—	0.004	0.006	0.001	0.010	0.010
13.5 to 20 GHz	—	—	0.006	0.001	0.010	0.010
20 to 40 GHz	—	—	—	—	0.020	0.020
40 to 50 GHz	—	—	—	—	—	0.020

Trace Noise (1 kHz BW), deg rms

Option	020	120	220	240	420	520
300 kHz to 10 MHz	0.080	0.080	—	0.110 ¹	—	—
10 to 45 MHz	0.030	0.030	0.025 ¹	0.025	0.100 ¹	0.100 ¹
45 MHz to 6 GHz	0.030	0.030	0.060	0.025	0.060	0.060
6 to 13.5 GHz	—	0.060	0.060	0.050	0.100	0.100
13.5 to 20 GHz	—	—	0.060	0.050	0.100	0.100
20 to 40 GHz	—	—	—	—	0.200	0.200
40 to 50 GHz	—	—	—	—	—	0.200

Maximum Levelled Output Power, dBm

Option	020	120	220	240	420	520
300 kHz to 10 MHz	10	10	—	8 ¹	—	—
10 to 45 MHz	10	10	—	8	—	—
45 MHz to 6 GHz	10	10	5	6	0	0
6 to 9 GHz	—	8	5	3	0	0
9 to 13.5 GHz	—	2	3	0	0	0
13.5 to 20 GHz	—	—	3	-3	0	0
20 to 40 GHz	—	—	—	—	-5	-5
40 to 50 GHz	—	—	—	—	—	-11

Measurement Speed

- Broadband sweep (10 MHz to 10 GHz, 50 kHz IF bandwidth, 201 points, no calibration): 97 ms²
- Narrowband sweep, Options 020, 025, 120, 125, 240, 245 (9.95 to 10.05 GHz, 600 kHz IF bandwidth, 201 points, no calibration): 7 ms³
- Narrowband sweep, Options 220, 225, 420, 425, 520, 525 (9.95 to 10.05 GHz, 250 kHz IF bandwidth, 201 points, no calibration): 9 ms³

Data Transfer Speed, 32-bit Binary (ms)¹

	201 points	1601 points
COM ⁴	0.4	2
SCPI (internal) ⁴	1	30
DCOM ⁵	0.8	7
SCPI over GPIB ⁵	7	435

¹ Typical

² Includes sweep, band-cross, and retrace time

³ Includes sweep and retrace time

⁴ Program executed in the PNA

⁵ Program executed on an external PC

Web Link

www.agilent.com/find/na
www.agilent.com/find/pna

N5241A
N5242A
N5244A
N5245A
N5247A

PNA-X Series Network Analyzer

N5241A 10 MHz to 13.5 GHz
N5242A 10 MHz to 26.5 GHz
N5244A 10 MHz to 43.5 GHz
N5245A 10 MHz to 50 GHz
N5247A 10 MHz to 67 GHz

Option configurations

To add options to a product, order the corresponding item number

	Description	For N5241A	For N5242A	For N5244A	For N5245A	For N5247A	Additional information
Test set							
Option 200	2-ports, single source	N5241A-200	N5242A-200	N5244A-200	N5245A-200	N5247A-200	
Option 224	2-ports, add internal 2nd source, combiner and mechanical switches	N5241A-224	N5242A-224	N5244A-224	N5245A-224	N5247A-224	Requires Options 200, one of 219 or H85, and 080
Option 400	4-ports, dual source	N5241A-400	N5242A-400	N5244A-400	N5245A-400	N5247A-400	Option 080 recommended
Option 423	4-ports, add internal combiner and mechanical switches	N5241A-423	N5242A-423	N5244A-423	N5245A-423	N5247A-423	Requires Options 400, one of 419 or H85, and 080
Power configuration							
Option 219	2-ports, extended power range and bias-tees	N5241A-219	N5242A-219	N5244A-219	N5245A-219	N5247A-219	Requires Option 200
Option 419	4-ports, extended power range and bias-tees	N5241A-419	N5242A-419	N5244A-419	N5245A-419	N5247A-419	Requires Option 400, Option 080 recommended
Option H85 ¹	High power configurable (for 2- or 4-port)	N5241AS-H85	N5242AS-H85	N5244AS-H85	N5245AS-H85	N/A	Requires Option 200 for 2-port, Option 400 for 4-port
Measurement applications							
Option 010	Time-domain measurements	N5241A-010	N5242A-010	N5244A-010	N5245A-010	N5247A-010	
Option 028 ²	Noise figure measurements using standard receivers	N5241A-028	N5242A-028	N5244A-028	N5245A-028	N5247A-028	Requires Option 080
Option 029 ²	Fully-corrected noise figure measurements	N5241A-029	N5242A-029	N/A	N/A	N/A	Requires one of Options 219, 224, 419, 423, or H85, and Option 080
Option H29 ²	Add 26.5 GHz noise receivers	N/A	N/A	N5244AS-H29	N5245AS-H29	N/A	Requires Option 423
Option 080	Frequency offset	N5241A-080	N5242A-080	N5244A-080	N5245A-080	N5247A-080	
Option 082 ³	Scalar-calibrated converter measurements	N5241A-082	N5242A-082	N5244A-082	N5245A-082	N5247A-082	Requires Option 080
Option 083 ³	Vector- and scalar-calibrated converter measurements	N5241A-083	N5242A-083	N5244A-083	N5245A-083	N5247A-083	Requires Option 080
Option 084	Embedded LO measurements	N5241A-084	N5242A-084	N5244A-084	N5245A-084	N5247A-084	Requires at least one of Options 028, 029, H29, 082, 083, 086, or 087
Option 086	Gain compression application	N5241A-086	N5242A-086	N5244A-086	N5245A-086	N5247A-086	Options 219, 419 or H85 recommended
Option 087	Intermodulation distortion application	N5241A-087	N5242A-087	N5244A-087	N5245A-087	N5247A-087	Requires Options 224 or 423
Option 460	Integrated true-mode stimulus application	N5241A-460	N5242A-460	N5244A-460	N5245A-460	N5247A-460	Requires Option 400
Option 551 ⁴	N-port capabilities	N5241A-551	N5242A-551	N5244A-551	N5245A-551	N5247A-551	
Nonlinear vector network analysis							
Option 510	Nonlinear component characterization	N5241A-510	N5242A-510	N5244A-510	N5245A-510	N/A	Requires Options 419 and 080, or 400, H85 and 080
Option 514	Nonlinear X-parameters ⁵	N5241A-514	N5242A-514	N5244A-514	N5245A-514	N/A	Requires Options 423 and 510
Option 518	Nonlinear pulse envelope domain	N5241A-518	N5242A-518	N5244A-518	N5245A-518	N/A	Requires Options 021 and 025 and either one of 510 or 514
Option 520	Arbitrary load-impedance X-parameters	N5241A-520	N5242A-520	N5244A-520	N5245A-520	N/A	Requires Option 514

Required NVNA accessories

- U9391C 10 MHz to 26.5 GHz or U9391F 10 MHz to 50 GHz comb generator (two required for nonlinear measurements)
- Agilent power meter and sensor or USB power sensor
- Agilent calibration kit, mechanical or ECal
- Agilent signal generator, MXG or PSG used for X-parameter extraction (internal 10 MHz reference output can be used for 10 MHz tone spacing applications)

¹ Order special model N524xAS instead of N524xA and add items N524xA Option 200 and N524xAS Option H85 for 2-port, extended power range, high power configuration, or items N524xA Option 400 and N524xAS Option H85 for 4-port, extended power range, high power configuration. Order N524xA Option xxx items for other standard options. Option H85 modifies the extended power range and bias-tees (Options 219 and 419), and therefore, they cannot be ordered together

² For source-corrected measurements, Options 028, 029, and H29 require an ECal module for use as an impedance tuner. For calibration, Options 029 and H29 also require a 346-series noise source (Agilent 346C recommended), while Option 028 requires a power meter. All options require a power meter for measuring mixers and converters

³ Option 082 is a subset of Option 083; therefore, they cannot be ordered together

⁴ When configured as a multipoint analyzer using Option 551 and a multipoint test set, the combiner feature of Option 224 or 423 is temporarily disabled. When configured as a standalone analyzer, the combiner feature is enabled. When ordering a test set, select an option to specify the appropriate interconnect jumper cable set between the analyzer and the test set

⁵ X-parameters is a trademark of Agilent Technologies

PNA Series Network Analyzer¹

E8362C 10 MHz to 20 GHz

E8363C 10 MHz to 40 GHz

E8364C 10 MHz to 50 GHz

E8361C 10 MHz to 67 GHz

N5250C² 10 MHz to 110 GHz

Option configurations

To add options to a product, order the corresponding item number

	Description	For E8362C	For E8363C	For E8364C	For E8361C	For N5250C system ³	Additional information
Test set							
Option 014	Configurable test set	E8362C-014	E8363C-014	E8364C-014	E8361C-014	Included	
Power configuration							
Option UNL	Extended power range and bias-tees	E8362C-UNL	E8363C-UNL	E8364C-UNL	E8361C-UNL	Included	Only E8361C requires 014
Option 016	Add receiver attenuators	E8362C-016	E8363C-016	E8364C-016	E8361C-016	E8361C-016	Requires UNL (only E8361C also requires 014)
Option H85 ⁷	High-power configuration	E8362CH85	E8363CH85	E8364CH85	Contact Agilent	Contact Agilent	Includes 014, 016, UNL ⁴ , 080, 081
Measurement applications							
Option 010	Time-domain capability	E8362C-010	E8363C-010	E8364C-010	E8361C-010	E8361C-010	
Option 080	Frequency offset	E8362C-080	E8363C-080	E8364C-080	E8361C-080	Included	Requires 014 (E8361C only, 081 required if UNL is also purchased)
Option 081	Reference receiver switch	E8362C-081	E8363C-081	E8364C-081	E8361C-081	Included	Requires 014, 080 (only E8361C also requires UNL)
Option 082	Scalar-calibrated converter measurements	E8362C-082	E8363C-082	E8364C-082	E8361C-082	E8361C-082 ⁵	Requires 014, 080
Option 083	Vector- and scalar-calibrated converter measurements	E8362C-083	E8363C-083	E8364C-083	E8361C-083	E8361C-083 ⁵	Requires 014, 080, 081 (only E8361C also requires UNL)
Option 084 ⁶	Embedded LO measurements	E8362C-084	E8363C-084	E8364C-084	E8361C-084	E8361C-084	Requires 082 or 083
Option 550 ⁹	4-port measurement application	E8362C-550	E8363C-550	E8364C-550	E8361C-550	N/A	Requires 014
Option 551 ⁹	N-port capabilities	E8362C-551	E8363C-551	E8364C-551	E8361C-551	N/A	Requires 014
Pulse, antenna, mm-wave							
Option H08	Pulsed-RF measurement capability	E8362C-H08	E8363C-H08	E8364C-H08	E8361C-H08	E8361C-H08 ⁵	Requires 014, 080 (Option H11 recommended)
Option H11	IF access (for antenna, pulsed-RF and mm-wave measurements)	E8362C-H11	E8363C-H11	E8364C-H11	E8361C-H11	Included	Requires 014, UNL, 080, and 081
Accessories							
Option 1CM	Rack mount kit for use without handles	E8362C-1CM	E8363C-1CM	E8364C-1CM	E8361C-1CM	E8361C-1CM	
Option 1CP	Rack mount kit for use with handles	E8362C-1CP	E8363C-1CP	E8364C-1CP	E8361C-1CP	E8361C-1CP	
N4688A	USB CD R/W drive	N4688A	N4688A	N4688A	N4688A	N4688A	
N4689A	USB Hub	N4689A	N4689A	N4689A	N4689A	N4689A	
Calibration documentation							
Option 1A7	ISO 17025 compliant calibration	E8362C-1A7	E8363C-1A7	E8364C-1A7	E8361C-1A7	E8361C-1A7	
Option UK6	Commercial calibration certificate with test data	E8362C-UK6	E8363C-UK6	E8364C-UK6	E8361C-UK6	E8361C-UK6	
Option A6J	ANSI Z540 compliant calibration	E8362C-A6J	E8363C-A6J	E8364C-A6J	E8361C-A6J	E8361C-A6J	
Calibration software for self-maintainers							
Option 897 ⁸	Perpetual license of built-in performance test software for Agilent exclusive calibration	E8362C-897	E8363C-897	E8364C-897	E8361C-897	E8361C-897	
Option 898 ⁸	Perpetual license of built-in performance test software for standards compliant calibration	E8362C-898	E8363C-898	E8364C-898	E8361C-898	E8361C-898	

¹ All models are not available in all countries

² For more detailed information regarding the 110 GHz network analyzer system, refer to the Agilent Web site: www.agilent.com/find/pna and download the N5250C technical overview, literature number 5989-7620EN

³ The N5250C 110 GHz system also includes an N5260A millimeter-wave test set controller, 1.0 mm combiner assembly, interconnect cables, and installation and productivity assistance

⁴ UNL⁴ does not include bias-tees. Only includes source attenuators

⁵ Up to 67 GHz

⁶ Requires firmware A.07.05 and above, plus 1.1 GHz CPU board

⁷ Option H85 is ordered as a separate model, as indicated

⁸ Additional hardware required. Please refer to the analyzer's service guide for required service test equipment

⁹ Option 550 is a subset of 551; therefore they cannot be ordered together. When ordering a test set, select an option to specify the appropriate interconnect jumper cable set between the analyzer and the test set

Web Link

www.agilent.com/find/na

www.agilent.com/find/pna

N5230C

PNA-L (N5230C)

Ordering guide for PNA-L Series network analyzers

This guide is intended to assist you in the ordering process. Additional information and products (such as calibration kits and cables) can be found in the PNA Configuration Guide (5988-7989EN).

Step 1: Select N5230C model number

Step 2: Choose your frequency range and test set

(Mandatory, choose only one)

Description	Ordering number
300 kHz to 6 GHz 2-port standard test set	Option 020
300 kHz to 6 GHz 2-port configurable test set and extended power range	Option 025
300 kHz to 13.5 GHz 2-port standard test set	Option 120
300 kHz to 13.5 GHz 2-port configurable test set and extended power range	Option 125
10 MHz to 20 GHz 2-port standard test set	Option 220
10 MHz to 20 GHz 2-port configurable test set and extended power range	Option 225
300 kHz to 20 GHz 4-port standard test set	Option 240
300 kHz to 20 GHz 4-port configurable test set and extended power range	Option 245
10 MHz to 40 GHz 2-port standard test set	Option 420
10 MHz to 40 GHz 2-port configurable test set and extended power range	Option 425
10 MHz to 50 GHz 2-port standard test set	Option 520
10 MHz to 50 GHz 2-port configurable test set and extended power range	Option 525

Step 3: Choose additional software options (Optional)

Description	Ordering number
Time domain for 6 GHz model	N52310-010
Time domain for 13.5, 20, 40 or 50 GHz model	N52300-010
Frequency-offset measurements	N52300-080

Step 4: Choose an electronic or mechanical calibration kit (Optional)

Description	Ordering number
300 kHz to 13.5 GHz, 4-port, Type-N or 3.5 mm connectors	N4431B
300 kHz to 26.5 GHz, 2-port 3.5 mm connectors	N4691B
10 MHz to 50 GHz, 2-port 2.4 mm connectors	N4693A

Step 5: Accessories (Optional)

Description	Ordering number
Rack mount kit without handle	Option 1CM
Rack mount kit with handles	Option 1CP
USB CD R/W drive	N4688A
USB Hub	N4689A

Step 6: Calibration documentation (Optional)

Description	Ordering number
ISO 17025 compliant calibration	Option 1A7
Commercial calibration certificate with test data	Option UK6
ANSI Z540 compliant calibration	Option A6J

Step 7: Choose your warranty and service (Optional)

Description
1-year return-to Agilent warranty and service
3-year return-to Agilent warranty and service

Web Link

www.agilent.com/find/pnal

www.agilent.com/find/na

www.agilent.com/find/pna

Calibration Kits

Error-correction procedures require that the systematic errors in the measurement system be characterized by measuring known devices (standards) on the system over the frequency range of interest. Agilent Technologies offers two types of calibration kits: mechanical and electronic. For further information about these products, please refer to the following web site www.agilent.com/find/naaccessories/



Mechanical Calibration Kits

All network analyzer, coaxial mechanical calibration kits contain standards to characterize systematic errors. Many mechanical calibration kits also contains adapters for test ports and a torque wrench for proper connection. Mechanical calibration kits are divided into three categories: economy, standard, and precision. Economy kits include a fixed load. Standard kits include a sliding load or a series of offset shorts. Precision kits contain TRL devices.

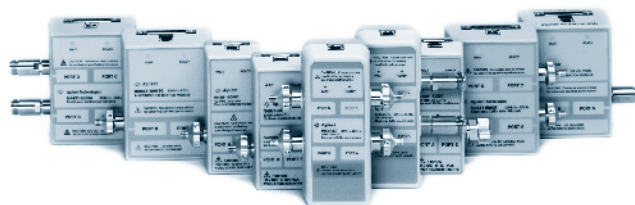

Electronic Calibration (ECal) Modules

Electronic calibration (ECal) is a precision, single-connection, 1-, 2-, or 4-port calibration technique that uses fully traceable and verifiable electronic calibration modules. ECal provides repeatable, accurate measurements while bringing convenience and simplicity to your daily calibration routine. ECal replaces the traditional calibration technique that uses mechanical standards. With mechanical standards, you are required to make numerous connections to the test ports for a single calibration. These traditional calibrations require intensive operator interaction, which is prone to errors. ECal modules consist of a connector-specific calibration standard. Modules are available with 3.5 mm, 7 mm, Type-N, Type-F, 2.92 mm, 2.4 mm, 1.85 mm and 7-16 connectors. Options exist for 2-port modules with one male and one female connector (MOF), two male (00M) or two female (00F) connectors. Four-port ECal modules support both mixed-sex and mixed-connector-type configurations. In addition to the standard factory characterizations of these connector configurations, users can characterize their ECal modules with adapters on the test ports. The resulting user-characterization data can then be saved into user memories within the ECal modules. The adapters can serve as "connector savers" or be used to change connector type or connector sex, giving maximum calibration flexibility. The user-characterization feature can also bring the convenience of ECal to fixture and wafer-probe environments.

The PNA and ENA Series of network analyzers can control ECal modules directly using a USB connection. 8753 and 8720 network analyzers control ECal modules via the 85097B VNA interface kit. For more information, refer to the ECal product overview (literature number 5963-3743E).

PC Interface Module with Control Software

The 85097B consists of a VNA interface module, and power supply. The interface module is the interface between the parallel port on your 8753 or 8720 network analyzer, the ECal module, and the external power supply. The 85097B interfaces with the 8753E/ET/ES, the 8719D/ET/ES, the 8720D/ET/ES and the 8722D/ET/ES network analyzers.

Mechanical Verification Kits

Measuring known devices, other than the calibration standards, is a way of verifying that the network analyzer system is operating properly. Agilent offers verification kits that include precision airlines, mismatch airlines, and precision fixed attenuators. Traceable measurement data, on disk, is shipped with each kit. Verification kits may be recertified by Agilent Technologies. This recertification includes a new measurement of all standards and new data with uncertainties.

Calibration kits
Verification kits

Coaxial Mechanical Calibration Kits

Legend: O = open S = short L = load SL = sliding load TRL = TRL adapter

Device connector type	Frequency upper limit ¹	Included	Available options	Model
Type-F (75 ohm)	3 GHz	O, S, L (m) and (f), adapters	00M, 00F	85039B
Type-N (75 ohm)	3 GHz	O, S, L (m)		85036E
Type-N (75 ohm)	3 GHz	O, S, L (m) and (f), adapters		85036B
Type-N (50 ohm)	6 GHz	O, S, L (m)		85032E
Type-N (50 ohm)	9 GHz	O, S, L (m) and (f)	100, 200, 300, 500	85032F
Type-N (50 ohm)	18 GHz	O, S, L, SL (m) and (f), adapters		85054B
Type-N (50 ohm)	18 GHz	O, S, L (m) and (f), adapters		85054D
7-16	7.5 GHz	O, S, L (m) and (f), adapters		85038A
7 mm	6 GHz	O, S, L		85031B
7 mm	18 GHz	O, S, L		85050D
7 mm	18 GHz	O, S, L, SL		85050B
7 mm	18 GHz	O, S, L, TRL		85050C
3.5 mm	9 GHz	O, S, L (m) and (f)	100, 200, 300, 400, 500	85033E
3.5 mm	26.5 GHz	O, S, L (m) and (f), adapters		85052D
3.5 mm	26.5 GHz	O, S, L, SL (m) and (f), adapters		85052B
3.5 mm	26.5 GHz	O, S, L (m) and (f), TRL adapters		85052C
2.92 mm	50 GHz	O, S, L, SL (m) and (f), adapters	001*	85056K
2.4 mm	50 GHz	O, S, L (m) and (f), adapters	001*	85056D
2.4 mm	50 GHz	O, S, L, SL (m) and (f), adapters	001*	85056A
1.85 mm	67 GHz	Offset, S, L (m) and (f), adapters		85058B
1.85 mm	67 GHz	O, S, L (m) and (f), adapters		85058E
1 mm	110 GHz	O, S, L (m) and (f), adapters		85059A

¹ All coaxial calibration kits are specified from DC to their upper frequency limit

Waveguide Mechanical Calibration Kits

Device connector type	Frequency range (GHz)	Type	Model
WR-90	8.2 to 12.4	Precision	X11644A
WR-62	12.4 to 18	Precision	P11644A
WR-42	18 to 26.5	Precision	K11644A
WR-28	26.5 to 40	Precision	R11644A
WR-22	33 to 50	Precision	Q11644A
WR-19	40 to 60	Precision	U11644A
WR-15	50 to 75	Precision	V11644A
WR-10	75 to 110	Precision	W11644A

Electronic Calibration Modules (ECal)

Device connector type	Frequency range	Available options	Model
Type-F (75 ohm) ¹	300 kHz to 3 GHz	00A, 00F, 00M, MOF, UK6	85099C
Type-N (75 ohm) ¹	300 kHz to 3 GHz	00A, 00F, 00M, MOF, UK6	85096C
Type-N (50 ohm) ¹	300 kHz to 9 GHz	00A, 00F, 00M, MOF, UK6	85092C
Type-N (50 ohm)	300 kHz to 18 GHz	00A, 00F, 00M, MOF, UK6	N4690B
7-16 ¹	300 kHz to 7.5 GHz	00A, 00F, 00M, MOF, UK6	85098C
7 mm ¹	300 kHz to 9 GHz		85091C
7 mm	300 kHz to 18 GHz		N4696B
3.5 mm ¹	30 kHz to 9 GHz	00A, 00F, 00M, MOF, UK6	85093C
3.5 mm	300 kHz to 26.5 GHz	00A, 00F, 00M, MOF, UK6	N4691B
PC Interface Kit ²	N/A	N/A	85097B
2.92 mm	10 MHz to 40 GHz	00A, 00F, 00M, MOF, UK6	N4692A
2.4 mm	10 MHz to 50 GHz	00A, 00F, 00M, MOF, UK6	N4693A
1.85 mm	10 MHz to 67 GHz	00A, 00F, 00M, MOF, UK6	N4694A
3.5 mm, Type-N 50 ohm, 7-16 (4-port)	300 kHz to 13.5 GHz	010, 020, UK6	N4431B
3.5 mm, Type-N 50 ohm, (4-port)	300 kHz to 18 GHz	020, 030, UK6	N4432A
3.5 mm (4-port)	300 kHz to 20 GHz	010, UK6	N4433A

¹ Modules have both USB and parallel connectors. A USB cable is supplied with the module

² The VNA interface unit is connected to the ECal module(s) via another parallel cable. The VNA interface kit is not needed with the PNA-X, PNA, PNA-L, ENA, and ENA-L Series network analyzers. These analyzers control the modules directly

Mechanical Verification Kits

Device connector type	Frequency range (GHz)	Type	Available Options	Compatible network analyzers	Model
Type-N	30 kHz to 18	Precision		8719, 8720, 8510, PNA, E5071C	85055A
7 mm	DC to 6	Precision	001**	8753	85029B
7 mm	0.045 to 18	Precision		8719, 8720, 8510, PNA, E5071C	85051B
3.5 mm	30 kHz to 26.5	Precision		8719, 8720, 8510, PNA, E5071C	85053B
2.4 mm	0.045 to 50	Precision		8722, 8510, PNA	85057B
1.85 mm	0.010 to 67 Hz	Precision		8510, PNA	85058V
WR-28	26.5 to 40	Precision		8510, 85106, PNA	R11645A
WR-22	33 to 50	Precision		8510, 85106, PNA	Q11645A
WR-19	40 to 60	Precision		8510, PNA	U11645A
WR-15	50 to 75	Precision		8510, 85106, PNA	V11645A
WR-10	75 to 110	Precision		8510, 85106	W11645A

Options apply to mechanical calibration, ECal, and verification kits

Option 001* adds 2.4 mm sliding load and 2.4 mm gauges

Option 001** adds data for 8702 lightweight component analyzer

Option 00A adds male to male and female to female adapters

Option MOF ECal module with one male and one female connector

Option OOF ECal module with two female connectors

Option OOM ECal module with two male connectors

Option 100 adds female to female adapter

Option 200 adds male to male adapter

Option 300 adds male to female adapter

Option 400 adds series of 3.5 mm to Type-N adapters

Option 500 adds series of 3.5 mm (or Type-N) to 7 mm adapters

UK6 commercial calibration with measured data

010 four female, 3.5 mm connectors

020 four female, Type-N 50 ohm connectors

030 four 7 mm connectors

Cables

Test port cables provide the connection required when using network analyzers with various test devices and equipment. Test port cables are available for two test configurations as shown below. Configuration A utilizes a single test port cable for use when the device under test (DUT) is connected directly to the port on the test set. Configuration B utilizes two test port cables; which provides more flexibility since the DUT is connected between the test port cables.

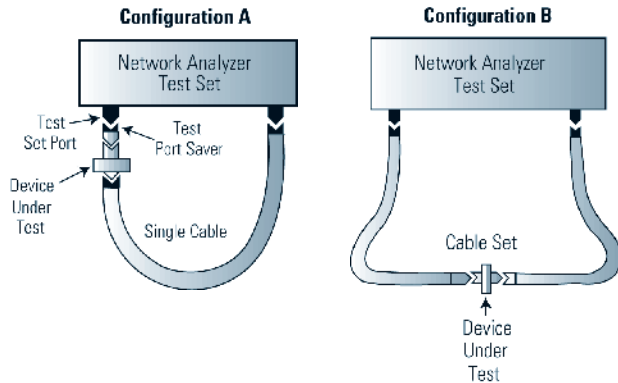

In order to select a cable, find the table below that corresponds to the connector type of your network analyzer. Then, search that table for your device's connector type. If the device's connector type is not present in the table, an adapter needs to be selected to mate the test port cable to your device. Adapters may be provided in a calibration kit, or ordered separately. A full detailed list of calibration kit contents is available from the web site: www.agilent.com/find/naaccessories/

50-ohm, Type-N Test Set Ports

Device connector type	Cable connector description	Model
Type-N	Type-N (m) to Type-N (m), 24 in (61 cm)	N6314A
Type-N	Type-N (m) to Type-N (f)	N6315A

75-ohm, Type-N Test Set Ports

Device connector type	Cable connector description	Model
Type-N	75 ohm, Type-N (m) to Type-N (m) 75 ohm, Type-N (m) to Type-N (f)	11857B
Type-F	75 ohm, Type-N (m) to Type-F (m) 75 ohm, Type-N (m) to Type-F (f)	11857F

7-mm Test Set Ports

Device connector type	Cable connector description	Model
7 mm	7 mm to 7 mm, qty 2	11857D

3.5-mm Test Set Ports

Device connector type	Cable type	Cable connector description	Model
7 mm	Flexible	3.5 mm (f) NMD to 7 mm 7 mm adapter set	85132E 85130B
7 mm	Flexible	3.5 mm (f) NMD to 7 mm 3.5 mm (f) NMD to 7 mm	85132F
3.5 mm	Semi-rigid	3.5 mm (f) NMD to 3.5 mm (f) 3.5 mm adapter set	85131C 85130D
3.5 mm	Semi-rigid	3.5 mm (f) NMD to 3.5 mm (f) 3.5 mm (f) NMD to 3.5 mm (m)	85131D
3.5 mm	Flexible	3.5 mm (f) NMD to 3.5 mm (f) 3.5 mm adapter set	85131E 85130D
3.5 mm	Flexible	3.5 mm (f) NMD to 3.5 mm (f) 3.5 mm (f) NMD to 3.5 mm (m)	85131F
Type-N	NMD to 7 mm	Use with 7 mm to Type N adapters Type N adapter set	85130C

NMD is a ruggedized connector type designed to mate only with the 8510, 8720 and PNA Series network analyzer test ports

2.4-mm Test Set Ports

Device connector type	Cable type	Cable connector description	Model
7 mm	Flexible	2.4 mm (f) NMD to 7 mm 7 mm adapter set	85135E 85130E
7 mm	Flexible	2.4 mm (f) NMD to 7 mm 2.4 mm (f) NMD to 7 mm	85135F
3.5 mm	Semi-rigid	2.4 mm (f) NMD to 3.5 mm (f) 3.5 mm adapter set	85134C 85130F
3.5 mm	Semi-rigid	2.4 mm (f) NMD to 3.5 mm (f) 2.4 mm (f) NMD to 3.5 mm (m)	85134D
3.5 mm	Flexible	2.4 mm (f) NMD to 3.5 mm (f) 3.5 mm adapter set	85134E 85130F
3.5 mm	Flexible	2.4 mm (f) NMD to 3.5 mm (f) 2.4 mm (f) NMD to 3.5 mm (m)	85134F
2.4 mm	Semi-rigid	2.4 mm (f) NMD to 2.4 mm (f) 2.4 mm adapter set	85133C 85130G
2.4 mm	Semi-rigid	2.4 mm (f) NMD to 2.4 mm (f) 2.4 mm (f) NMD to 2.4 mm (m)	85133D
2.4 mm	Flexible	2.4 mm (f) NMD to 2.4 mm (f) 2.4 mm adapter set	85133E 85130G
2.4 mm	Flexible	2.4 mm (f) NMD to 2.4 mm (f) 2.4 mm (f) NMD to 2.4 mm (m)	85133F

NMD is a ruggedized connector type designed to mate only with the 8510, 8720 and PNA Series network analyzer test ports

1.85-mm Test Set Ports

Device connector type	Cable type	Cable connector description	Model
1.85 mm	Flexible	1.85 mm (f) to 1.85 mm (f) 1.85 mm adapter set	N4697C 85130H
1.85 mm	Flexible	1.85 mm (f) to 1.85 mm (f) 1.85 mm (f) to 1.85 mm (m)	N4697F

1.0-mm Test Set Ports

Device connector type	Cable connector description	Model
1.0 mm	1.0 mm (f) to 1.0 mm (f)	11500I
1.0 mm	1.0 mm (f) to 1.0 mm (m), 16 cm	11500J
1.0 mm	1.0 mm (f) to 1.0 mm (m), 20 cm	11500K
1.0 mm	1.0 mm (f) to 1.0 mm (m), 24 cm	11500L

Network Analyzer Accessories

11930A/B Power Limiters

The 11930A/B limiters protect the input circuits of network analyzers, spectrum analyzers, and sources from transients and short-duration overloads.

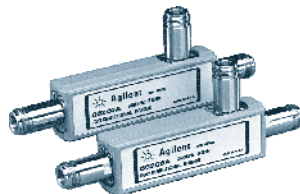

86205A/86207A



85024A

86205A/86207A RF Bridges

The 86205A/86207A high directivity RF bridges offer unparalleled performance in a variety of general-purpose applications. They are ideal for accurate reflection measurements and signal leveling applications.

85024A High-Frequency Probe

The 85024A high-frequency probe makes it easy to perform in-circuit measurements. An input capacitance of only 0.7 pF shunted by 1 MΩ of resistance permits high-frequency probing without adversely loading the circuit-under-test. Excellent frequency response and unity gain guarantee high accuracy in swept measurements with this probe. High probe sensitivity and low distortion levels allow measurements to be made while taking advantage of the full dynamic range of RF analyzers. RF network analyzers such as the 8753ET/ES, 8753E, 3577A, and 4195A are directly compatible. Additionally, the 8560, 8590E, and ESA Series signal analyzers are also compatible. You can use the 1122A probe power supply or any dual ±15 V, 130 mA supply.

11852B 50 ohm/75 ohm Minimum Loss Pad

The 11852B is a low SWR minimum loss pad used to transform 50-ohm port impedance to 75-ohm or 75-ohm to 50-ohm.

Type-N Accessory Kits

Each kit contains a Type-N (female) short, a Type-N (male) short, two Type-N (male) barrels, two Type-N (female) barrels, and a storage case.

11853A 50-ohm Type-N accessory kit

Accessory kit furnishes components for measurement of devices with 50-ohm Type-N connectors.

11878A Type-N/3.5 mm adapter kit

Adapter kit contains: 3.5 (f) to Type-N (M), 3.5 (m) to Type-N (m), 3.5 (f) to Type-N (f), and 3.5 (m) to Type-N (f).

BNC Accessory Kits

The BNC accessory kit contains two Type-N (male) to BNC (female) adapters, two Type-N (male) to BNC (male) adapters, two Type-N (female) to BNC (female) adapters, two Type-N (female) to BNC (male) adapters, a BNC (male) short, and a storage case.

11854A 50-ohm BNC accessory kit

Accessory kit furnishes components for measurement of devices with 50-ohm BNC connectors.

7-16 Adapter Kits

1.0 mm test port connectors

Adapters	Connector type
11920A/B/C ¹ adapters	1.0 mm Series adapters
11921A/B/C/D ¹ adapters	1.0 mm to 1.85 mm Series adapters
11922A/B/C/D ¹ adapters	1.0 mm to 2.4 mm Series adapters
11923A adapters	1.0 mm (f) to circuit card launch
V281C/D ² adapters	1.0 mm to V-band waveband guide
W281C/D ² adapters	1.0 mm to W-band waveband guide

¹ Suffix 'A' denotes male-to-male, 'B' denotes female-to-female, 'C' denotes male-to-female and 'D' denotes female-to-male

² Suffix 'C' denotes 1.0 mm female and 'D' denotes 1.0 mm male

Ordering Information

11930A/B power limiters

86205A/86207A RF bridges

85024A high-frequency probe

11852B 50-ohm/75-ohm minimum loss pad

Type-N accessory kits

11853A 50-ohm Type-N accessory kit

11878A Type-N/3.5 mm adapter kit

BNC accessory kits

11854A 50-ohm BNC accessory kit

Web Link

www.agilent.com/find/mta

2 MHz to 4/6 GHz

- Cable and antenna test, distance-to-fault, return loss, cable loss
- Vector network analysis with Smith chart display
- Vector voltmeter

5 kHz to 4/6 GHz

- Spectrum analyzer, CHP, ACPR, OBW
- Interference analyzer, spectrogram, waterfall, record and playback



N9912A FieldFox

Cable and Antenna Analyzer

Use FieldFox to make return loss, VSWR, insertion loss/transmission, one-port cable loss, and distance-to-fault (DTF) measurements. You can test antennas, cables, filters, and amplifiers with a single instrument.

Industry's First and Only QuickCal

The industry's first and only built-in calibration system allows you to calibrate the cable/antenna tester without carrying a calibration kit into the field. As with any test instrument, when you add an additional device to the test port, such as a jumper cable or attenuator, you need to calibrate using a calibration kit (cal kit). *QuickCal* eliminates the hassle of carrying and using a cal kit, plus provides worry-free accuracy and excellent repeatability every time.

Built-in Spectrum Analyzer

FieldFox has an optional built-in spectrum analyzer that covers frequency ranges from 5 kHz to 6 GHz. It provides a fast spectrum scan to detect interference and RF burst capture to measure intermittent signals. It displays four traces at the same time, and you can choose different detector modes.

Interference Analyzer

FieldFox provides a spectrogram and waterfall display to detect intermittent interference signals or monitor signals of interest for longer periods of time. Signal traces can be recorded into internal memory or external flash memory devices, the saved traces can be played back for offline processing.

Network Analyzer

FieldFox has an optional network analyzer mode that provides standard vector network analyzer measurements such as S11, S11 phase, a Smith chart display, polar display, and S21 magnitude.

Vector Voltmeter

Using FieldFox's vector voltmeter (VVM), the phase shift and electrical length of a device can be measured.

Specifications**Cable and antenna analyzer frequency range**

- Option 104: 2 MHz to 4 GHz
- Option 106: 2 MHz to 6 GHz

Directivity

- Corrected: > 42 dB

Spectrum analyzer frequency range

- Option 104: 100 kHz to 4 GHz, usable to 5 kHz
- Option 106: 100 kHz to 6 GHz, usable to 5 kHz, tunable to 6.1 GHz

Resolution bandwidth (RBW)

- Zero span: 300 Hz to 1 MHz in 1-3-10 sequence; 2 MHz
- Non-zero span: 10 Hz to 300 kHz in 1/1.5/2/3/5/7.5/10 sequence; 1 MHz, 2 MHz

Trace updates

- Span = 20 MHz, RBW = 3 kHz: 1.5 updates/second

Ordering Information

N9912A FieldFox RF network analyzer

N9912A-104 4 GHz cable and antenna analyzer

N9912A-106 6 GHz cable and antenna analyzer

N9912A-110 transmission measurement

N9912A-111 QuickCal

N9912A-230 4 GHz spectrum analyzer (requires Option 104)

N9912A-231 6 GHz spectrum analyzer (requires Option 106)

N9912A-235 preamplifier for spectrum analyzer (requires Option 230 or 231)

N9912A-236 interference analyzer

N9912A-302 external USB power sensor support

N9912A-303 network analysis capability

N9912A-308 vector voltmeter

Web Link

www.agilent.com/find/fieldfox

N9923A

- Full 2-port error corrected S-parameters, magnitude and phase
- Cable and antenna test (distance-to-fault, return loss, and VSWR)
- Cable loss measurement (1-port)
- Insertion loss and transmission measurement (2-port)
- Smith chart and polar display
- Vector voltmeter (1- and 2- channel)
- Power meter with external USB power sensor



N9923A FieldFox

Vector Network Analysis

The base FieldFox RF VNA provides transmission/reflection (T/R) measurements, or S11 and S21, with magnitude and phase.

Adding Option 122 (full 2-port S-parameters) brings new levels of accuracy and convenience for testing RF components. A full 2-port network analyzer lets you measure forward and reverse characteristics of your components without having to disconnect, turn around, and reconnect them to the analyzers.

It also provides full 2-port calibration to give you the best measurement accuracy possible. Depending upon your application, you can choose the optimum performance level of an S-parameter analyzer (Option 122) or transmission reflection analyzer (base model).

You also can simultaneously measure and view all four S-parameters, with a single connection.

Cable and Antenna Analyzer

Fifty to sixty percent of cell site problems are caused by faulty cables, connectors, and antennas. Degraded feed lines cause poor coverage, unnecessary handovers, paging failures and access failures on the uplink. To avoid service quality problems, it is critical to keep the cell sites' cable and antenna systems in good condition.

Use FieldFox to make return loss, VSWR, insertion loss/transmission, one-port cable loss, and distance-to-fault (DTF) measurements. You can test antennas, cables, filters, and amplifiers with a single handheld instrument.

Industry's First and Only QuickCal

FieldFox is the industry's first and only handheld network analyzer with a built-in calibration capability that allows you to calibrate the network analyzer without carrying a calibration kit into the field. *QuickCal* eliminates the need to carry and use a cal kit, and also provides worry-free accuracy and excellent reliability. *QuickCal* allows the operator to easily correct drift errors caused by temperature changes during instrument operation.

The FieldFox RF VNA's full 2-port *QuickCal* supports measurements such as transmission/reflection, S21, S12, S11, S22, 1-port cable loss, VSWR, return loss, DTF, and gain/insertion loss. Full 2-port *QuickCal* is based on Agilent's unknown thru calibration methodology, providing an accurate way to measure a non-insertable device, such as a female-female filter.

Vector Voltmeter

Using FieldFox's vector voltmeter (VVM), the phase shift and electrical length of a device can be measured.

Specifications

Measurements

- S11, S21: magnitude and phase
- S12, S22: magnitude and phase (Option 122)
- System impedance selection: 50 and 75 ohm (with 50/75 ohm adapter)

Frequency range

- Option 104: 2 MHz to 4 GHz
- Option 106: 2 MHz to 6 GHz

Data points

- 101, 201, 401, 601, 801, 1001

Directivity

- Corrected: 42 dB

System dynamic range (S21)

- 2 MHz to 6 GHz: 100 dB (typical)

Output power range

- High power: +6 dBm (nominal)
- Low power: -40 dBm (nominal)

Ordering Information

N9923A FieldFox RF vector network analyzer

N9923A-104 4 GHz RF vector network analyzer, transmission/reflection

N9923A-106 6 GHz RF vector network analyzer, transmission/reflection

N9923A-112 QuickCal

N9923A-122 full 2-port S-parameters

N9923A-305 cable and antenna analyzer

N9923A-302 external USB power sensor support

N9923A-308 vector voltmeter

Web Link

www.agilent.com/find/fieldfox



Fast Accurate Answers Throughout the Digital Debug and Validation Cycle

Agilent's logic analyzers minimize your project risk by providing the most reliable, accurate data capture and the most complete view of digital system behavior. A comprehensive family of products offers a variety of form factors, acquisition speeds, memory depths, channel counts, and application-specific analysis and protocol tools to create a solution that will meet your toughest digital debug needs.

Key Features and Benefits in Addition to Industry Leading State and Timing Acquisition

Features	Benefits
Eye scan	Identify problem signals quickly by viewing eye diagrams across all buses and signals simultaneously
Eye finder	Eliminate the need for manual fine-tuning and ensure the highest confidence in accurate state measurements on high-speed buses with automatic setup and hold adjustments on every channel
Timing zoom	Make high resolution timing measurements while simultaneously performing state analysis through the same connection
View scope	Validate the logical and timing relationships between the analog and digital portions of your design with digital and analog waveforms integrated in a single display
Intuitive triggering	Customize a trigger for your specific application with drag-and-drop icons that can be used as individual trigger events or building blocks for complex scenarios
Pattern generation	Verify operation across a variety of test conditions with normal or faulty digital patterns at full speed or by stepping through individual states

Selection Guide for Logic Analysis Solutions

	16800 Series portable logic analyzers	16900 Series modular logic analysis systems
Form factor	Portable fixed configurations deliver an exclusive combination of logic analysis, pattern generation, application software, and innovative probing – all at a price to fit limited budgets	A modular system enables you to customize the system for your specific application. 2-slot or 6-slot systems offer the most flexibility and the highest performance for multiple bus analysis
Form factor benefits	<ul style="list-style-type: none"> • Purchase exactly the capability you need • Maximize your bench space with a smaller footprint 	<ul style="list-style-type: none"> • Configure the system for your specific acquisition and stimulus needs • Get long-term investment protection – upgrade or re-configure as your needs evolve • Maximize your measurement capability with the highest channel counts, highest state and timing speeds, deepest memory depth and support for single ended and differential signals
Timing speed	4 GHz timing zoom Up to 1 GHz conventional timing	Up to 4 GHz timing zoom Up to 8 GHz conventional timing
State speeds	Up to 500 Mb/s	Up to 2.5 Gb/s
Memory depth	Up to 32 M	Up to 256 M (512 M in half channel)
Channels	34, 68, 102, 136, or 204	From 34 up to 9,782
Applications	Digital debug and validation Embedded FPGA	Memory A/D converters FPGA/ASIC Signal integrity Multiple bus analysis
Additional considerations	Probes and accessories. Wide variety of processor, bus, FPGA and protocol solutions. Optional application and analysis software packages	

Web Link

www.agilent.com/find/logic
www.agilent.com/find/logicdemos

16801A
16802A
16803A
16804A
16806A
16821A
16822A
16823A

- **15-inch (38.1 cm) color display (touch screen available) allows you to see more data and gain insight quickly**
- **Up to 32 M memory depth enables you to identify the root cause of a problem widely separated in time from the symptom**
- **Models with a built-in pattern generator allow you to verify operation across a variety of test conditions**
- **Set up measurements easily and navigate through your data quickly with the analyzer's intuitive interface**
- **Meet your application and budget needs by selecting configurations that range from 34 to 204 channels**

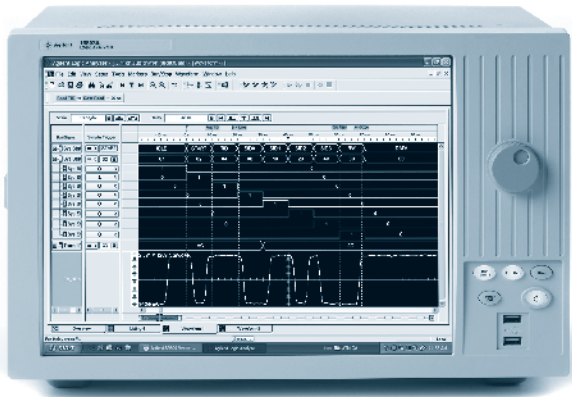

Advanced Measurements for Your Digital Applications at a Price that will Fit Your Budget

16800 Series portable logic analyzers offer the performance, application support, and usability your digital development team needs to quickly debug, validate, and optimize your digital system. Meet your application and budget needs by selecting from eight models that range from 34 to 204 channels.

Accurately measure precise timing relationships over longer periods of time with 4 GHz (250 ps) timing zoom at 64 K deep. Find anomalies separated in time with memory depths upgradeable to 32 M. You get it all at a price that fits your budget.

Models with an integrated pattern generator let you control and monitor real-time system operation. Drive down risk early in product development by replacing missing circuits or boards with digital stimulus. Verify operation across a variety of test conditions with normal or faulty digital patterns at full speed or by stepping through individual states.

Specifications

Model	16801A 16821A	16802A 16822A	16803A 16823A	16804A	16806A
Logic analyzer channels	34	68	102	136	204
Pattern generator channels	48	48	48	N/A	N/A
High speed timing zoom	4 GHz (250 ps) with 64 K depth				
Maximum timing sample rate	1/0 GHz (1.0 ns) half channel / 500 MHz (2.0 ns) full channel				
Maximum state clock rate	250 MHz	450 MHz with Option 500/ 250 MHz with Option 250			
Maximum state data rate	250 Mb/s	500 Mb/s with Option 500/ 250 Mb/s with Option 250			
Maximum memory depth	1 M standard; 4, 16, or 32 M optional				
Supported signal types	Single-ended				

Ordering Information

Options

The following options apply to all 16800 Series logic analyzers:

- 16800A-102** front panel with 15" display
- 16800A-103** front panel with 15" display and touch screen
- 16800A-101** internal hard drive
- 16800A-109** external removable hard drive

For the following options, use the desired model number prior to the "-option number"

- 16800 Series model number-001** 1 M memory depth standard
- 16800 Series model number-004** increase memory depth to 4 M
- 16800 Series model number-016** increase memory depth to 16 M
- 16800 Series model number-032** increase memory depth to 32 M
- 16800 Series model number-250** maximum state speed of 250 MHz
- 16800 Series model number-500** increase maximum data rate to 500 Mb/s (Option 500 applies to 16802A, 16803A, 16804A, 16806A, 16822A, and 16823A)

Upgrades

To increase memory depth or state speed after initial purchase, specify the desired state speed and memory depth options for the following upgrade numbers:

- E5876A** for upgrading an existing 16801A or 16821A
- E5877A** for upgrading an existing 16802A or 16822A
- E5878A** for upgrading an existing 16803A or 16823A
- E5879A** for upgrading an existing 16804A
- E5880A** for upgrading an existing 16806A

Probes

Probes are ordered separately. Choose a probe that fits your application from the list of 16800 Series compatible probes on page 105.

Pattern generator clock and data pods See page 104 for details

Web Link

www.agilent.com/find/logic

- Configure a system for your specific application with a wide range of acquisition and stimulus modules
- Protect your investment by purchasing a system with the capability you need now, then expand as your needs evolve
- View cross-domain measurements, correlated in time across the entire system
- Maximize your measurement capability with hundreds of channels, > 2 GHz state, up to 8 GHz timing, and up to 256 M deep memory
- Identify problem signals quickly by viewing eye diagrams across all buses and signals simultaneously with eye scan



2-slot and 6-slot modular logic analysis systems

Configure Custom Measurement Solutions for Demanding Applications

The Agilent 16900 Series logic analysis systems provide high-performance, system-level debugging of digital designs. Configure a system for your specific debug and validation needs with innovative probing, high-performance acquisition and stimulus modules, and post-processing analysis tools.

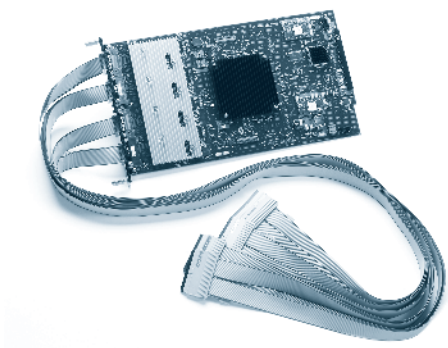

Specifications

Model	16910A/16911A	16950B/16951B	16962A
Logic analyzer channels	102/68	68/68	68
Max channels on single time base	510/340	340/340	340
Number of analyzers (time bases)	2	2	1
Maximum state clock rate	250 MHz (standard) 450 MHz with Option 500	667 MHz	2 GHz
Max state data rate	250 Mb/s (standard) 500 Mb/s with Option 500	667 Mb/s (DDR) 1066 Mb/s (Dual sample)	2 Gb/s (DDR) 2.5 Gb/s (Dual sample)
Minimum state clock rate	Low Hz	Low Hz	40 MHz
High speed timing zoom	4 GHz (250 ps) with 64 k depth	4 GHz (250 ps) with 64 k depth	N/A
Max timing sample rate	1 GHz half ch/ 500 MHz full ch	1.2 GHz half ch/ 600 MHz full ch	8 GHz quarter ch/ 4 GHz half ch/ 2 GHz full ch
Transitional timing	500 MHz full ch	600 MHz full ch	8 GHz quarter ch/ 4 GHz half ch/ 2 GHz full ch
Memory depth	256 K standard, 1 M, 4 M, 16 M, 32 M optional	16950B: 1 M std, 4 M, 16 M, 32 M, 64 M optional 16951B: 256 M std	4 M standard 16 M, 32 M, 64 M, 100 M optional
Supported signal types	Single-ended	Single-ended and differential	Single-ended and differential

16901A
16902B
16910A
16911A
16950B
16951B
16962A

Ordering Information

A complete system consists of a logic analyzer mainframe, measurement modules, probes and optional application and analysis software. Refer to pages 103-107 for additional information on measurement modules, probes and optional application and analysis software.

Mainframes

16901A 2-slot logic analysis mainframe

16901A-109 external removable hard drive

16902B 6-slot logic analysis mainframe with built-in removable hard drive

Logic analyzer modules

16910A and 16911A specify desired state speed and memory depth option when ordering

16950B and 16962A specify desired memory depth option when ordering

16951B comes with 256 M memory depth standard

Probes

Probes are ordered separately. Choose a probe that fits your application from the list of compatible probes on page 105.

Upgrades

To increase memory depth or state speed after initial purchase, specify the desired state speed and memory depth options for the following upgrade model numbers:

E5865A for upgrading an existing 16910A

E5866A for upgrading an existing 16911A

E5875A for upgrading an existing 16950B

E5887A for upgrading an existing 16962A

Web Link

www.agilent.com/find/logic

16720A
View Scope

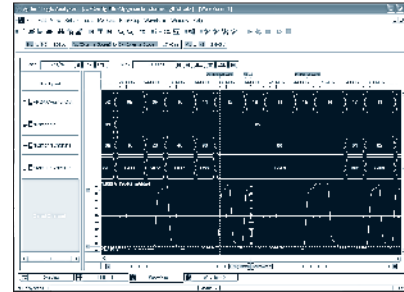
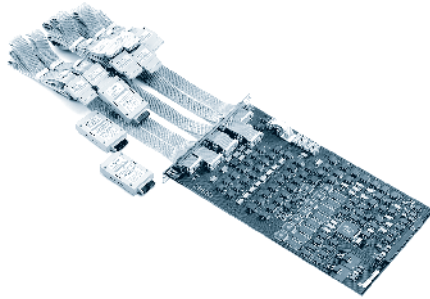

Digital Stimulus for Performing Functional Verification, Debugging and Stress Testing

The Agilent 16720A digital pattern generator module for Agilent's 16900 Series logic analysis systems is ideal for the functional testing of your digital design. The pattern generator is used to simulate infrequently encountered test conditions in hardware design and software program testing. You can also use a pattern generator to stimulate your electronic designs with ideal or faulty digital patterns for performing functional verification, debugging and stress testing.

Specifications

Agilent 16720A pattern generator module

	Half channels	Full channels
Maximum clock speed	300 MHz	180 MHz
Memory depth in vectors	16 M	8 M
Maximum number of channels per timebase	24	48
Maximum vector width	120 bits	240 bits
Stimulus commands	Initialize, block, repeat, and break macros	
Logic levels supported	5 V TTL, 3-state TTL, 3-state CMOS, 3-state 3.3 V, ECL, 5 V PECL, 3.3 V LVPECL, 3-state 2.5 V, 3-state 1.8 V, LVDS	

Ordering Information

You must order at least one clock pod for each pattern generator used as a master. You must order at least one data pod for every 8 output channels.

Pattern generator clock and data pods

Logic level	Pod type	Order to get individual pod or lead set		Order to get pod and lead set together
		Pod	Lead set	
TTL	Clock	10460A	10498A	16720A-011
TTL/CMOS (3-state)	Data	10462A	10498A	16720A-013
TTL	Data	10461A	10498A	16720A-014
2.5 V	Clock	10472A	10498A	16720A-015
2.5 V (3-state)	Data	10473A	10498A	16720A-016
3.3 V	Clock	10477A	10498A	16720A-017
3.3 V/TTL (3-state)	Data	10483A	10498A	16720A-018
ECL	Clock	10463A	10498A	16720A-021
ECL terminated	Data	10464A	10498A	16720A-022
ECL unterminated	Data	10465A	10347A	16720A-023
5 V PECL	Clock	10468A	10498A	16720A-031
5 V PECL	Data	10469A	10498A	16720A-032
3.3 V LVPECL	Clock	10470A	10498A	16720A-033
3.3 V LVPECL	Data	10471A	10498A	16720A-034
1.8 V	Clock	10475A	10498A	16720A-041
1.8 V (3-state)	Data	10476A	10498A	16720A-042
LVDS	Clock	E8140A	E8142A	16720A-051
LVDS	Data	E8141A	E8142A	16720A-052

Unleash the Complementary Power of a Logic Analyzer and an Oscilloscope

Easily make time-correlated measurements between an Agilent logic analyzer and oscilloscope. The time-correlated logic analyzer and oscilloscope waveforms are integrated into a single logic analyzer waveform display for easy viewing and analysis.

View Scope Capabilities Include:

- Automatic de-skew of the waveforms
- Trigger the oscilloscope from the logic analyzer (or vice versa)
- Precisely relate information on the instrument displays with tracking markers
- Maintain tight time-correlation across deep memory acquisitions with synchronized sampling clocks

Logic Analyzer/Oscilloscope Connection:

Use standard LAN connection and two BNC cables to connect trigger in and trigger out

Agilent Oscilloscope Capabilities

- Maximum scope bandwidth: 32 GHz
- Maximum sampling rate: 80 GS/s
- Maximum memory depth: 2 G points
- Channels per oscilloscope: 2 and 4

Compatible Agilent Oscilloscopes

- Infiniium 90000 X-Series, 90000 A-Series
- Infiniium 9000 Series
- Infiniium 8000 Series
- InfiniiVision 7000 Series
- InfiniiVision 6000 Series
- InfiniiVision 5000 Series

Compatible Logic Analyzers

- 16800 Series portable logic analyzers
- 16900 Series modular logic analyzers

Web Link

www.agilent.com/find/logic_modules

- Easily connect with reliable, electrically and mechanically unobtrusive probing solutions
- Achieve low loading (< 0.7 pF), an easy connection, and a small footprint with soft touch connectorless probes
- Save time making bus- and processor-specific measurements with application specific analysis probes

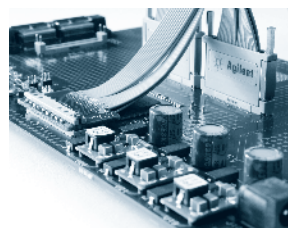

Soft touch connectorless

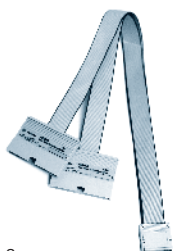

Samtec



Mictor



Flying lead set

Accurate Measurements Start with Reliable Probing

Your logic analyzer measurement is only as reliable as your probing. Agilent offers a wide variety of probing accessories that support general-purpose and application specific measurement needs. The probes provide a robust, reliable connection between your Agilent logic analyzer and the system under test. They are easy to connect and are electrically and mechanically unobtrusive, giving you unsurpassed measurement accuracy.

- E5346A
- E5378A
- E5379A
- E5380A
- E5381A
- E5382A
- E5383A
- E5385A
- E5387A
- E5390A
- E5394A
- E5396A
- E5398A
- E5402A
- E5404A
- E5405A
- E5406A

Specifications

Recommended probes for Agilent logic analyzers

Probe type	Application	Connection to the target system
Flying lead	Flexible connection to individual signals	Compatible with a wide assortment of accessories to connect to individual leads, traces, pads and vias
Connector – Mictor	Quick connection to many signals in a small footprint	Requires 38-pin Mictor connector designed into target system
Connector – Samtec	Quick connection to many signals in a small footprint	Requires 100-pin Samtec connector designed into target system
Soft touch connectorless	Quick connection to many signals in a small footprint without a connector designed into the target	Requires original (E53XX) or Pro Series (E54XX) soft touch footprint designed into the target system

Probes compatible with 16800 Series portable logic analyzers, and 16910A and 16911A logic analyzer modules (SE = single ended)

Probe type	Soft touch connectorless probes			Samtec probe	Mictor probe	General purpose flying leads
Product	E5396A	E5404A	E5394A	E5385A	E5346A	E5383A
Channels	17 16 data, 1 clock	34 32 data, 2 clock	34 32 data, 2 clock	34 32 data, 2 clock	34 32 data, 2 clock	17 16 data, 1 clock
Supported signal types	SE clock, SE data	SE clock, SE data	SE clock, SE data	SE clock, SE data	SE clock, SE data	SE clock, SE data
Maximum data rate	> 2.5 Gb/s	> 2.5 Gb/s	> 2.5 Gb/s	1.5 Gb/s	Equivalent to the logic analyzer data rate the probe is attached to	Equivalent to the logic analyzer data rate the probe is attached to
Minimum signal amplitude	500 mV p-p	500 mV p-p	500 mV p-p	500 mV p-p	500 mV p-p	600 mV p-p
Input capacitance	< 0.7 pF	< 0.7 pF	< 0.7 pF	1.5 pF	3.0 pF	1.5 pF

Probes compatible with 16962A, 16951B, and 16950B logic analyzer modules (Diff = differential, SE = single ended)

Probe type	Soft touch connectorless probes					Probe type	Samtec probes		Mictor probe	General purpose flying leads	
	Product	E5398A	E5406A E5402A (low profile)	E5390A	E5405A		E5387A	Product		E5378A	E5379A
Channels	17 16 data, 1 clock	34 32 data, 2 clock	34 32 data, 2 clock	17 16 data, 1 clock	17 16 data, 1 clock	Channels	34 32 data, 2 clock	17 16 data, 1 clock	34 32 data, 2 clock	17 16 data, 1 clock	17 16 data, 1 clock
Supported signal types	Diff or SE clock, SE data	Diff or SE clock, SE data	Diff or SE clock, SE data	Diff or SE clock, Diff or SE data	Diff or SE clock, Diff or SE data	Supported signal types	Diff or SE clock, SE data	Diff or SE clock, Diff or SE data	SE clock, SE data	Diff or SE clock, SE data	Diff or SE clock, Diff or SE data
Maximum data rate	> 2.5 Gb/s	> 2.5 Gb/s	> 2.5 Gb/s	> 2.5 Gb/s	> 2.5 Gb/s	Maximum data rate	1.5 Gb/s	1.5 Gb/s	600 Mb/s	1.5 Gb/s	1.5 Gb/s
Minimum signal amplitude	250 mV p-p	250 mV p-p	250 mV p-p	$V_{min} - V_{max}$ 200 mV	$V_{min} - V_{max}$ 200 mV	Minimum signal amplitude	250 mV p-p	$V_{min} - V_{max}$ 200 mV	300 mV p-p	250 mV p-p	$V_{min} - V_{max}$ 200 mV
Input capacitance	< 0.7 pF	< 0.7 pF	< 0.7 pF	< 0.7 pF	< 0.7 pF	Input capacitance	1.5 pF	1.5 pF	3.0 pF	1.3 pF	0.9 pF

Web Link

www.agilent.com/find/logic_analyzer_probes

16962A
B4621A
B4622A
B4623A
W263x
Series
W363x
Series

- **2 GT/s state analysis and 2.5 GT/s dual state analysis capture up to 1867 GT DDR memory traffic and beyond**
- **DDR eye finder and DDR eye scan enable reliable data capture**
- **2 GHz trigger sequencer ensures you don't miss critical events**
- **Agilent's industry first, data burst trigger allows you to trigger on 8-bit data bursts on every channel**
- **Up to 125 ps (8 GHz) timing analysis captures up to 400 M of memory system activity at high resolution**
- **Multiple probing options for your specific DDR memory configuration**

Comprehensive Solutions for DDR2, DDR3, LPDDR & LPDDR2

The Agilent DDR memory solutions provide memory controller designers, DDR memory designers and system integrators with a comprehensive tool set to integrate, debug and execute compliance testing on their DDR based memory sub-systems. Agilent's DDR memory solutions include probing, high-speed acquisition, and measurement tools for data analysis and signal integrity insight.

Don't see support for your memory device? As the market leader in DDR memory measurements, Agilent continues to expand its portfolio of memory solutions. Contact Agilent for the latest update and customized solutions.

Multiple, Non-Intrusive Probing Options for Your Specific DDR Memory Configuration

Agilent provides a variety of probing options, for your DDR based memory sub-system. The breadth of probing options has been developed to enable interconnect to the various DDR memory families and physical implementations. The portfolio includes DIMM and SODIMM interposers, mid-bus probes and BGA probes.

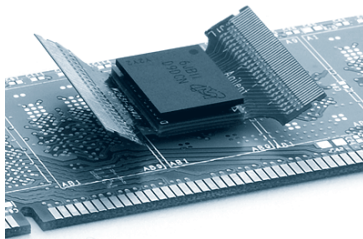

Repeatable, Reliable Data Acquisition for Complex DDR Memory Systems

The core of the Agilent DDR memory solutions is the data acquisition capabilities provided by the 16962A logic analyzer module. The attributes of the 16962A that make it the ideal data acquisition engine for DDR applications are:

- 2 GT/s state analysis and 2.5 GT/s dual state analysis capture up to 1867 GT DDR memory traffic and beyond
- DDR eye finder and DDR eye scan enable reliable data capture

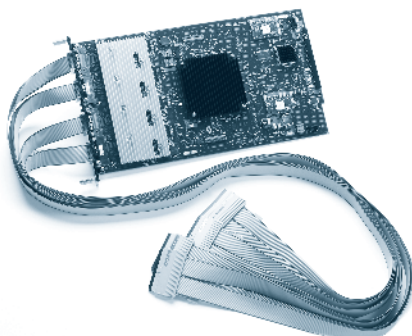

- 2 GHz trigger sequencer ensures you don't miss critical events
- Agilent's industry first, data burst trigger allows you to trigger on 8-bit data bursts on every channel
- Up to 125 ps (8 GHz) timing analysis captures up to 400 M of memory system activity at high resolution

DDR Protocol Measurements and Signal Integrity Insight, All Through a Single Connection

As the data rates for DDR memory continue to increase, signal integrity across these wide busses becomes increasingly complex to debug and validate. The Agilent DDR solutions provide two industry first capabilities which provide signal integrity insight across all channels with a single data acquisition.

Qualified eye scan enable users to qualitatively examine eye diagrams on all data channels for reads or writes to a specific address or bank of memory.

Burst scan enables users to qualitatively evaluate eye characteristics for data burst traffic.

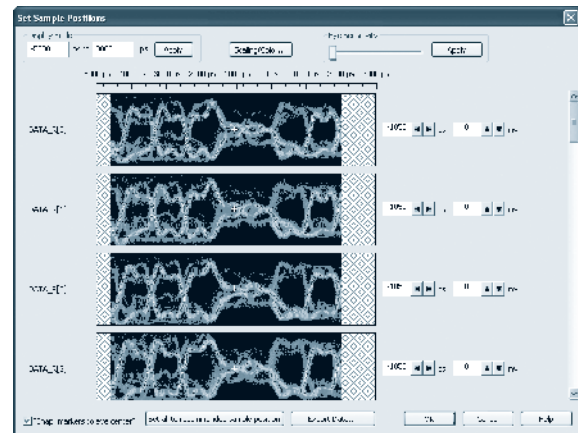

Transform Raw DDR Bus Traffic into Memory System Insight

To accelerate the integration, debug and compliance testing of your memory sub-system, Agilent provides a family of DDR data analysis tools including bus decoders, DDR protocol compliance tool, advanced triggering and performance analysis tools. The Agilent family of DDR data analysis tools enables memory sub-system development teams to rapidly transform bus traffic into the insight required to validate their designs.

Ordering Information

- 16962A** logic analysis module, 68-ch, 2 GHz timing, 2 GT/s state, 4 M depth
- B4621A** bus decoder for DDR2 and DDR3
- B4623A** bus decoder for LPDDR1 and LPDDR2
- B4622A** DDR and LPDDR protocol compliance and analysis tool
- W263x Series** DDR2 BGA probes
- W363x Series** DDR3 BGA probes

Contact factory for LPDDRx BGA probing

Web Link

www.agilent.com/find/16962A
www.agilent.com/find/ddr2bga

- Select from a comprehensive portfolio of industry standard FPGAs, ARM® cores, processors and buses
- Display processor mnemonics or bus cycle decode

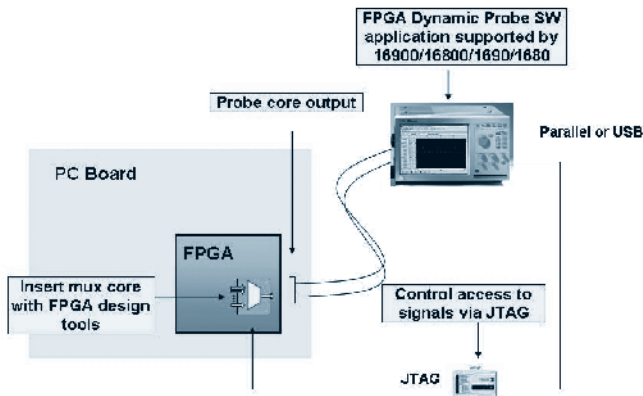

Quickly Debug Your FPGA and Surrounding System with X-ray Vision for Your FPGAs

FPGAs play an increasingly important role in your digital designs. The high level of integration available in today's FPGAs allows you to use them in ways that weren't envisioned just a few years ago.

- Gain visibility into the internal activity of your Xilinx and Altera FPGAs. Access up to 128 internal signals for each pin dedicated to debug
- Switch internal probe points in seconds to measure a different set of internal signals without changing your FPGA design
- Leverage the work you did in your design environment. The FPGA dynamic probe maps internal signal names from your FPGA design software to the logic analyzer. Automated bus name and signal setup eliminates mistakes and saves time
- Time-correlate internal FPGA and external system activity in order to solve your toughest debug challenges

Save Time Analyzing Your Unique Design with a Turnkey Logic Analyzer Setup

Agilent and our partners provide an extensive range of quality tools that offer non-intrusive, full-speed, real-time analysis to accelerate your debugging process.

Get Additional Insights Into Your Design with Multiple Views and Analysis Tools

As the complexity of digital systems increases, you need to analyze and view data in ways that were previously unavailable in a logic analyzer. Take advantage of the multiple analysis tools that enable you to rapidly consolidate large amounts of data into displays that provide rapid insight into your system's behavior.

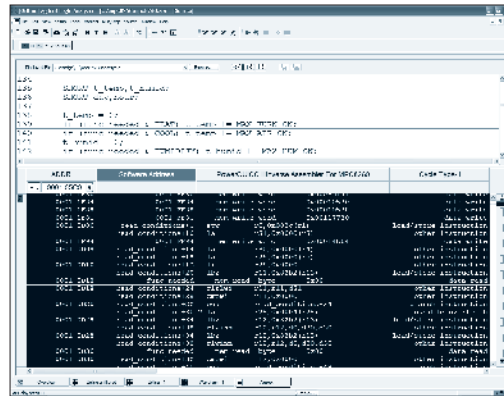

The split source window displays the source code on top and the inverse-assembled trace below. The two traces are time-correlated and track as you scroll

Debug ARM Cortex ETM and PTM Activity at the Source Level

ARM cores are pervasive in embedded designs. ARM Cortex embedded trace macrocell (ETM) and program trace macrocell (PTM) support is essential to overall system visibility, debug and validation.

- Correlate the logic analyzer capture of ARM Cortex ETM/PTM activity to the high-level source code that produced it
- View raw data or the decoded trace for a specific core in a multiple core design
- Filter out Wait states to capture more activity
- Supports ARM Cortex A8 ETM and ARM Cortex A9 PTM

Ordering Information

Unless noted otherwise

order Option 010 for perpetual node locked license
order Option 020 for perpetual floating (server) license

FPGA solutions

- B4655A** FPGA dynamic probe for Xilinx
 - B4655A-011** perpetual node locked license
 - B4655A-012** perpetual floating (server) license
- E9524A** MicroBlaze
- B4656A** FPGA dynamic Probe for Altera

ARM Cortex decoders

- E9528A** ARM Cortex ETM decoder
- E9529A** ARM Cortex PTM decoder

Data viewing and analysis packages

- B4601C** Serial-to-parallel analysis package
- B4602A** signal extractor tool
- B4606A** advanced customization environment – development and runtime package
- B4607A** advanced customization environment – runtime package
- B4608A** remote programming interface (RPI)
- B4610A** data import tool
- B4641A** protocol development Kit

Digital vector signal analysis (DVSA)

- 89601A-200** basic vector signal analysis software
- 89601A-300** hardware connectivity (includes link to logic analyzers)

Contact Agilent if you do not see support for your specific vendor or device. A representative can:

- Determine if support is under development
- Recommend third parties that design custom solutions
- Direct you to information or consultants that can help you design a test solution

Web Link

www.agilent.com/find/pnbs
www.agilent.com/find/logic-sw-apps

- B4601C
- B4602A
- B4606A
- B4607A
- B4608A
- B4610A
- B4630A
- B4641A
- B4655A
- B4656A
- E9528A
- E9529A

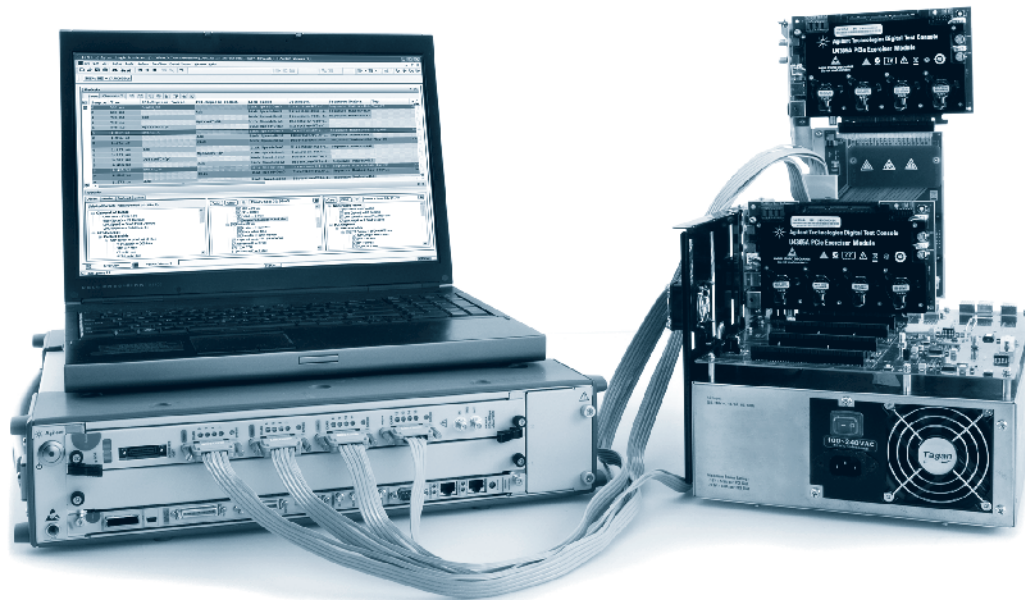

Protocol Testing for High Speed Serial Busses in Computer, Embedded Systems, Mobile Devices and Wireless Infrastructure

As your design includes multi gigabit serial interconnect standards, the Agilent family of modular protocol analyzers/exercisers is the most effective solution to debug, validate and optimize semiconductors, software and systems that use serial protocol standards for computer, storage, mobile and embedded systems.

Agilent's protocol test solutions for each technology typically consists of both protocol analyzer application as well as a stimulus solution, such as a exerciser or traffic generator. Based on modular, scalable and multi-user system, Agilent's protocol test solutions (part of the digital test console) combines multi-protocol analysis, traffic generation, performance and conformance verification to debug, validate and optimize your designs using high speed protocol standards.

Agilent's protocol solutions includes multiple technologies, and various applications :

- The *protocol analyzer* application helps you transparently record in real-time the traffic patterns between two devices and easily visualize the trace information from bit level to the packet level with the right protocol decoding capabilities. Additional application and performance measurements and advanced triggering capabilities help quickly identify the root cause of your design problems
- The *exercisers or traffic generator* application can stimulate your design with sophisticated traffic scenarios, and help accelerate test phases such as functional or system validation. These applications also provide sophisticated device emulation capabilities to recreate complex or large scale test environments
- *Compliance test solutions* will perform tests in order to verify and ensure compliance with specifications defined by the standard bodies

Agilent's protocol solutions cover a range of technologies, including PCI Express for storage and computing technologies, as well as support for technologies such as MIPI for the mobile computing space.

Web Link

- www.agilent.com/find/protocol
- www.agilent.com/find/pcie
- www.agilent.com/find/pcie3
- www.agilent.com/find/rdx
- www.agilent.com/find/hdmi_analyzer
- www.agilent.com/find/csi
- www.agilent.com/find/dsi

- **Reliable traffic capture from Gen1 through Gen3 speeds**
- **X1 through x16 support on the analyzer with a variety of probing methods; mid-bus probes, interposer probes, flying leads probes and more**
- **Thorough link testing using the x1 to x16 LTSSM exerciser to test the different state transitions including the recovery sub-state**
- **Use the exerciser/protocol analyzer capabilities in combination to analyzer root cause of problems with ease**
- **External trigger in/out to synchronize with other devices**

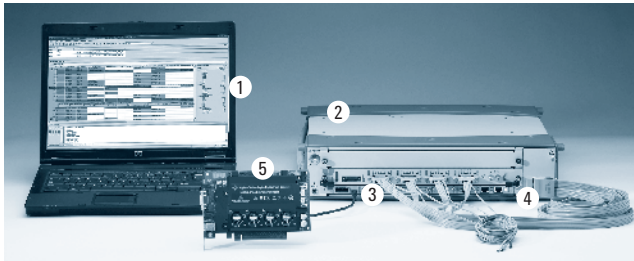

U4300A Series PCI Express 3.0 platform

1. PC controller to manage and interact with the system
2. U4002A: digital test console 2-slot chassis
3. U4301A protocol analyzer module controlled via PCIe x4 cable link from the PC controller
4. U4322A soft touch mid-bus probe 3.0
5. U4305A PCIe exerciser and LTSSM tester, controlled via USB 2.0

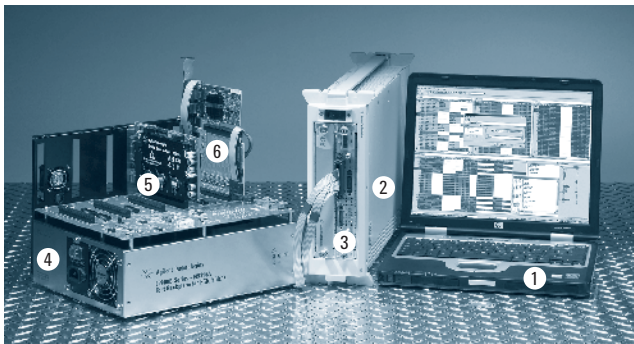

E2960B PCI Express 2.0 platform

1. PC controller to manage and interact with the system. Multiple connection options for the controller:
 - 100 Mbps Ethernet LAN directly from PC controller to chassis
 - USB to LAN dongle available for USB connectivity to PC
2. Chassis (2 slot or 4 slot available)
3. N5306A protocol analyzer module controlled via LAN or USB 2.0 link from the PC controller
4. N5316A test backplane, allows testing of end points without vendor system
5. N5309A exerciser module controlled via LAN or USB 2.0 link from the PC controller
6. N5315A slot interposer probe

Agilent's PCI Express Test Solution – Faster Time to Insight

The U4300A Series for PCI Express 3.0, 2.0 and 1.0

Agilent's digital test console PCI Express protocol test solution supports all speeds of PCIe, 2.5 GT/s (Gen1), 5.0 GT/s (Gen2) through PCIe 8 GT/s (Gen3). The digital test console is the industry's most complete test solution for PCIe 3.0, with a PCIe analyzer, PCIe exerciser and a variety of probes (including mid-bus and slot interposer probes) utilizing the ESP (equalizing snoop probe) technology.

Flexible hardware architecture

Agilent's PCIe analyzer combines the accurate probing technology with a flexible hardware architecture. The analyzer hardware supports all three generations, PCIe 1.0 through PCIe 3.0, and supports x1 link width through x16. Agilent's protocol analyzers use a modular chassis based architecture. This gives you additional flexibility, a single x16 configuration can be split up into 2 separate smaller link width test system, so that you can get the maximum utilization on your equipment purchases.

Analyzer with industry unique ESP technology for accurate data capture

For any analyzer at PCIe 3.0 speeds, the key is how to recover the signal accurately in different types of platforms and systems. Agilent's PCIe 3.0 analyzer uses Agilent's unique ESP (equalization snoop probe) technology, with the ability to tune the equalization algorithm used according to the type of channel the analyzer is monitoring. This ensures that the data captured in the analyzer is exactly what is on the wire. Without this capability, at 8 GT/s, there is a high likelihood of misrepresentation of the data on the bus, which can lead to wasted hours, if not days in the validation cycle.

Thorough link testing

The PCIe 3.0 exerciser with pre-defined LTSSM test cases can help validate the complex and hard to test state transitions of DUT's LTSSM. With the ability to emulate either a root complex or an end point in the same card, the PCIe 3.0 exerciser can help you validate your device whether it is a server or an add-in card. The emulated personality is easily switched through a simple software switch.

Aside from the pre-defined LTSSM test cases, the PCIe 3.0 exerciser can be controlled also through an built-in API interface, which is backward compatible with Agilent's PCIe 2.0 exerciser. This allows you to leverage test cases already developed for maximum investment protection.

The E2960B Series for PCI Express 2.0 and 1.0

The E2960B Series for PCIe 2.0 (5 Gb/s) provides customers with the fastest time to insight by providing an integrated suite of analyzer and exerciser tools. With data capture users can trust on a cost effective solution, customers can bring their product to market quickly.

E2960B protocol analyzer for PCI Express gives you fast access to reliable and understandable data

The E2960B protocol analyzer for PCI Express captures the traffic transactions on a PCI Express link and allows you to analyze it and troubleshoot problems to find the root cause. The protocol analyzer provides non-intrusive monitoring of traffic between two PCI Express devices (either a system talking to an add-in card or the exerciser talking to an add-in card or system). With its capabilities in analyzing generated PCI Express traffic, the analyzer is perfectly suited for turn-on and debug of PCI Express systems and designs.

The analyzer captures and analyzes packets from the physical up to the transaction layer as well as training sequences and ordered sets. The analyzer can be configured for all link width (x1 up to x16) and speed grades (2.5 and 5 GT/s). Advanced triggering capabilities that reduce the time needed to detect even difficult to find errors are available on all solutions.

The analyzer features "per lane LEDs" that give an instantaneous feedback on the link, lane and speed status (manual and automatic speed setting), both on the I/O module as well as the GUI. The "per lane display" shows data even prior to channel bonding completion including 8b, 10b or K/D symbols. 2 "Trigger-down-the-lane" patterns allow triggering on ordered sets on selected lanes. An easy-to-use GUI offers graphical trigger setup, search and filter capabilities to help you intuitively interpret PCI Express transactions. The context sensitive and easy flow technologies allow to display data easily understandable but also very condensed.

The E2960B analyzer offers various different probing options to support PCI Express 1.0 and 2.0 probing. The probing options include interposer probing, mid-bus probing, express card and flying leads.

- U4301A
- U4321A
- U4322A
- U4305A
- N5306A
- N5309A
- N5315A
- N4241A
- N4241F/Z

U4301A
U4321A
U4322A
U4305A
N5306A
N5309A
N5315A
N4241A
N4241F/Z

E2960B protocol exerciser and jammer for PCI Express lets you test and validate your system's performance under varied conditions

With its fully adjustable parameters, the E2960B protocol exerciser lets you emulate any PCI Express design. Furthermore it is capable to generate and respond to any PCI Express packet or sequences of packets. It is an intelligent I/O communication tool that can react as a PCI Express end node or root complex. The E2960B exerciser's functionality extends far beyond the capabilities of a simple packet generator. It is tailored to validate corner cases and emulate stress conditions for components on system boards and add-in cards. The protocol exerciser is the ideal tool to test and validate x1 up to x16 PCI Express designs.

The E2960B jammer can be used to reproduce difficult problems reliably and accurately to determine the root cause problem in real life setups. The jammer allows you to inject errors into a real system, with any OS and any driver and any application. There is ability to test for all categories of errors, including: correctable, uncorrectable non fatal and uncorrectable fatal. With the built in sequencer this allows the ability to inject errors conditionally, to give you the most flexibility in reproducing very specific errors.

Specifications

U4300A Series PCI Express analyzer specifications

Reliable traffic capture and analysis

Hardware

- Supports 2.5 GT/s (Gen1), 5.0 GT/s (Gen2) and 8.0 GT/s (Gen3) speeds
- Link width support x1 through x16 lanes
- Large capture buffer, 8 GB for x16 link, or 4 GB per x1, x4 or x8 link
- Probing through Agilent's unique ESP technology

Industry standard spreadsheet style GUI for effective presentation of protocol interactions

- Lane view via E2960B software (offline)
- Packet viewer with flexible coloring, color by packet type or direction
- Easy flow columns to better understand the stimulus and response nature of the protocols
- Transaction viewer grouping all related packets, and metrics for each transaction via E2960B software (offline)

Simple use and powerful state based triggering

- 4 states supported in trigger sequence
- Triggering on errors such as illegal sync characters, loss of framing, illegal block, etc
- Triggering on patterns (ordered set patterns, or packet types)
- Internal counters and timers

Family of superior probing solutions to meet your application needs

The protocol analyzer has a full array of probing solutions, including mid-bus, and slot interposer, from x1 to x16.

- Mid-bus probes are designed with low capacitive loading to minimize signal distortion
- The slot interposer probe combines outstanding analog repeating technology with mechanical robustness, to allow probing where signal integrity is marginal

U4300A Series PCI Express exerciser specifications

Fully validate the DUT (device under test)

- Supports 2.5 GT/s (Gen1), 5.0 GT/s (Gen2) and 8.0 GT/s (Gen3) speeds
- Link width support x1 through x16 lanes
- Standard PCIe half size card form factor, to fit into most platforms
- Emulates both root complex and endpoint to allow testing of any type of DUT for PCI Express 3.0
- Uses the exerciser and test backplane to test the end point without a system
- Automates testing with the built-in API interface

Thorough link testing transition of the DUT's LTSSM

- Pre-defined LTSSM tests can help validate complex and hard to test state
- Detailed reporting to clearly define source of problem for faster debug

E2960B Series PCI Express analyzer specifications

Reliable traffic capture and analysis

System traffic is easy to understand with the x1 to x16 analyzer

- 2.5 and 5 Gb/s PCI Express traffic is reliably captured
- Advanced triggering capabilities reduce the time needed to detect difficult-to-find errors

- Reliable data capture even exiting L0s, with the industry's fastest lock time of 3 to 5 fast training sequences (typical)
- It is fast and easy to understand the data through context-sensitive column analysis with easy flow views
- SR-IOV and MR-IOV decodes to support debug and analysis even for the latest specifications from PCI-SIG®

Full package of post processing features including:

- Flow control credit counting and graphing
- Transaction viewer and transaction metrics
- Real time statistics graphing and post processed performance statistics
- Traffic overview

Family of superior probing solutions to meet your application needs

The protocol analyzer has a full array of probing solutions, including mid-bus, slot interposer, and flying lead probes, from x1 to x16

- Mid-bus and flying lead probes are designed with low capacitive loading to minimize signal distortion
- The slot interposer probe combines outstanding analog repeating technology with mechanical robustness, to allow probing where signal integrity is marginal
- Low profile mid-bus probe for access in blade server environments

E2960B Series PCI Express exerciser specifications

Fully validate the DUT (device under test)

- Emulates both root complex and endpoint to allow testing of any type of DUT for PCI Express 2.0
- Uses the exerciser and test backplane to test the end point without a system
- Automates testing with the built-in API interface

The jammer:

- Validate the DUT and software under extreme conditions by creating corner cases and injecting inline errors
- Inject errors into a real system with any OS and any driver and any application
- Easy to setup, the jammer is transparent to the PCI Express hierarchy. Just insert it into a working system, and start testing

Thorough link testing transition of the DUT's LTSSM

- Pre-defined LTSSM tests can help validate complex and hard to test state
- Easily validate new additions to the 2.0 specifications, including dynamic lane width changes, and link negotiations

Compliance testing

- Over 170 compliance test scripts (as defined by the PCI-SIG) quickly test for compliance to the PCI Express 2.0 specifications at the transaction, data link layers, as well as in the configuration space
- The exerciser has an easy-to-use GUI; a single click to run all tests, or subsection of test cases
- Precise reports to clearly identify pass, fail, and warning results

Ordering Information

LTSSM exerciser sample configuration

Test cards

U4305A-E16 exerciser board x16 for PCIe 8 GT/s

U4305A-EX3 exerciser software license

Software

U4305A-LT3 LTSSM software license

Analyzer sample configuration

Chassis

U4002A digital test console two-slot chassis

U4002A-EXP PCI Express cable to Express card adapter for laptop connections

U4002A-2MC PCIe cable (2.0 m)

Test blades

U4301A analyzer blade hardware

U4301A-A08 analyzer linkwidth x8

Software

U4301A-AN3 analyzer software license for PCIe 8 GT/s

Probes

U4321A-A08 slot interposer 3.0 for PCIe 8 GT/s x8

Web Link

www.agilent.com/find/pcie3

- Independently validate your DigRF based BB-IC and RF-IC
- Rapidly deploy DigRF based designs using Agilent's integrated and cross-correlated logic analysis and RF tools
- Get insight from bit level to IQ modulated RF signals
- Get the greatest confidence on your mobile handset design from turn-on through integration



DigRF v3 analysis & stimulus

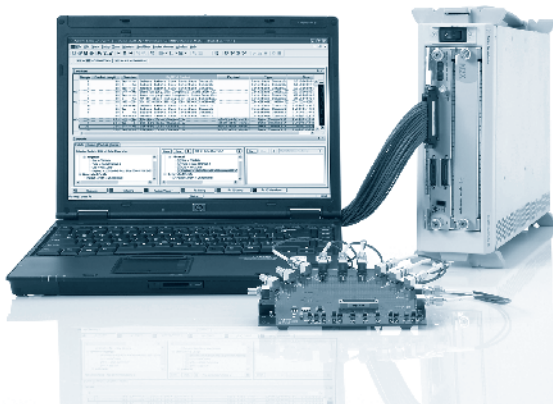

RDX – DigRF v4 analysis & exerciser

DigRF v3 Protocol Test Solution

The N4850A digital acquisition probe and N4860A digital stimulus probe operate in conjunction with 16800 and 16900 Series logic analyzers. The probes provide digital acquisition and serial stimulus capabilities required for DigRF v3 based IC evaluation and integration.

The integration of DigRF v3 logic analysis tools with the Agilent RF portfolio provides cross-domain solutions that will help you rapidly deploy your DigRF v3-based designs.

RDX – DigRF v4 Protocol Test Solution

The ultimate solution for DigRF testing and characterization, the RDX platform provides a single test environment that helps you validate DigRF v4 protocols under real world conditions. With powerful emulation software and protocol-specific hardware test cards, you can quickly explore a broad range of test cases. The included protocol generation and analysis software interoperates with the industry-leading Agilent signal studio software and 89600 VSA analysis software to enable RF physical domain stimulus and analysis across an RF-IC chip.

The N5343A exerciser module provides serial stimulus capabilities required for DigRF v3 or v4 based IC evaluation and characterization. A single module combines stimulus and capture capabilities to generate configurable control and data traffic and observe the response from the device under test. It allows engineers to work in the domain (digital or RF) of their choice to quickly characterize the DUT's digital and wireless behavior. It operates in conjunction with Agilent vector signal generation and analysis software.

The N5344A analysis module transparently monitors DigRF v4 bus activity, helping digital and RF engineers integrate and troubleshoot devices incorporating the DigRF digital serial bus across a wide variety of over the air standards. The analyzer module allows engineers to work in the domain (digital or RF) of their choice to quickly characterize the DUT's digital and wireless behavior. It operates in conjunction with Agilent vector signal analysis software.

Specifications

N4850A/N4860A DigRF v3 digital acquisition and stimulus probe key specifications

State analysis for DigRF v3 – compliant devices

- Maximum acquisition speed: 312 Mbps
- Voltage level support: 1.8 V LVDD, 1.2 V LVDS, SLVDS
- SysClk speed support: 19.2 MHz, 26.0 MHz, 38.4 MHz
- Over air standard support: 2.5G and 3GPP (e.g. GSM, EDGE, CDMA, CDMA-2k, W-CDMA)

Monitor device and system operation

- Simultaneously acquires Tx/Rx bidirectional traffic
- Tracks changes across all speed modes – sleep, low power and high speed
- Displays data and control packets at the protocol level
- Triggers on protocol-specific packets, specific bits within a packet, and protocol violations

Additional capabilities

- LEDs show DigRF v3 bus status and error conditions
- Identifies invalid sync words
- Supports up to 2048 bits for user-defined payload
- Extracts and transfers digital IQ for analysis with 89601A VSA software

RDX (Radio Cross Domain) DigRF v4 analyzer and exerciser key specifications

Exerciser N5343A key specifications

- Support DigRF v3 and DigRF v4 bus specifications
- Support speeds up to 3 Gb/s, with single or multi-lane configuration
- Integrated stimulus and capture capabilities on a single module

Exerciser features and operation

- Provides digital stimulus for DigRF v3 or v4 based RF-IC and BB-IC
- Smart stimulus with protocol state machine emulation
- Customize header, payload and frame sequence generation
- Converts raw IQ and control information to DigRF v3 and v4 compliant packets

Analyzer N5344A key specifications

- Support DigRF v4 bus specifications
- Support speed up to 3 Gb/s, with single or multi-lane configuration
- Full protocol decoding capabilities
- Extracts and transfers digital IQ for analysis with 89601A VSA software

Analyzer features and operation

- Simultaneously acquires Tx/Rx bidirectional traffic
- Tracks changes across all speed modes – sleep, slow power, and high speed
- Displays data and control packets at the protocol level
- Triggers on protocol-specific packets, specific bits within a packet, and protocol violations

N4850A
N4860A
N5343A
N5344A

N4850A
N4860A
N5343A
N5344A

Ordering Information

DigRF v3 configuration guide

To configure a complete DigRF v3 digital acquisition and stimulus system, you will need to order or have the following items:

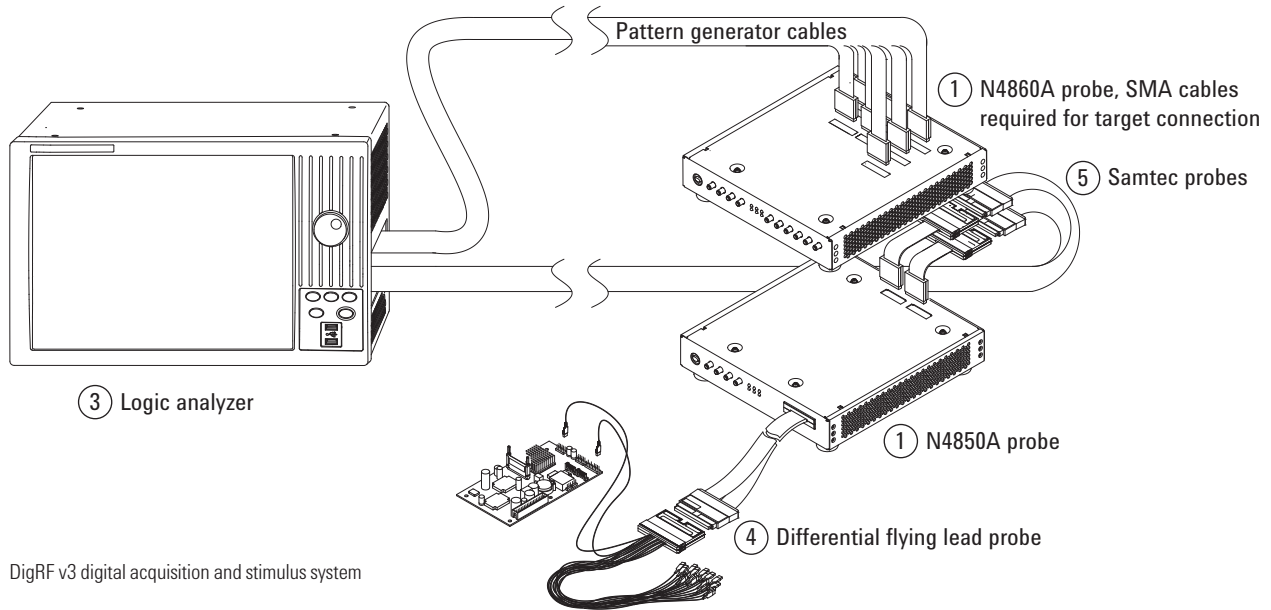

DigRF v3 digital acquisition and stimulus system

1. DigRF v3 probes ¹ (One each per Tx/Rx pair)	2. Method to create IQ data	3. Logic analyzer with 48-channel pattern generator ²	Probes between the N4850A and the...	
			4. Device under test (One of the following for each N4850A)	5. Logic analyzer (Two Samtec probes per N4850A – one for Tx and one for Rx. Select probe that is compatible with your logic analyzer)
N4860A 312 Mbps digital stimulus probe • N4860A-040: Set of four 40 inch SMA cables N4850A 312 Mbps digital acquisition probe • -010 for node-locked license • -020 for floating (server) license	<ul style="list-style-type: none"> • Signal Studio • ADS • Convert captured logic analyzer trace to stimulus • Custom programmatic generation 	16800 Series portables • 16822A – 68 ch • 16823A – 102 ch 16900 Series modular mainframe with at least one each of the following: • 16900 Series module(s) • 16720A pattern generator module	<ul style="list-style-type: none"> • E5381A differential flying lead probe • E5405A differential pro series soft touch probe • E5387A differential soft touch probe • E5379A differential Samtec probe 	<ul style="list-style-type: none"> • E5385A for logic analyzers with a 40-pin cable connection (16822A, 16823A, 16910/11A) • E5378A for logic analyzers with a 90-pin cable connection (1695X modules)

¹ N4860A digital stimulus probe requires an N4850A digital acquisition probe to operate

² Compatible with 16800 or 16900 Series logic analyzers with 68 channels or more. Diversity mode requires use of a 16900 modular system with one 68-channel (or more) logic analyzer module for each Tx/Rx pair

DigRF v4 configuration guide

Chassis

N5302A 2-slot, 2U high chassis

N5304A 4-slot, 2U high chassis

Test cards

N5343A DigRF exerciser module

N5343A-V3E DigRF v3 stimulus license

N5343A-V3A DigRF v3 capture license

N5343A-V4E DigRF v4 stimulus license

N5343A-V4A DigRF v4 capture license

N5344A DigRF analyzer module

N5344A-V4A DigRF v4 capture license

Probes

N5345A soft touch mid bus probe

N5346A flying leads

Web Link

www.agilent.com/find/RDX

- Enables user-controlled execution of individual or multiple HDMI protocol/audio/video compliance tests
- Captures up to 4 GB of HDMI data for protocol analysis
- Processes captured HDMI data with frame details (e.g. number of packets in the frame, specific packet types, video data periods, etc.)
- Generates HDMI protocol and audio patterns, including deep color patterns
- Provides 3D generation and analysis
- Includes extended colorimetry and content type support
- Supports deep color 30-bit, 36-bit and 48-bit



N5998A HDMI protocol /audio/video analyzer and generator

The N5998A is the reference high-speed

- protocol analyzer
- video timing analyzer
- video picture analyzer
- audio timing analyzer
- audio/video protocol generator

for HDMI compliance tests required by the compliance test specification (CTS 1.4a). The global HDMI authorized test centers (ATCs) rely on the N5998A.

The N5998A HDMI 1.4a protocol/audio/video analyzer and generator is controlled by HDMI analysis software running on an external PC. The HDMI analysis software is part of the N5998A.

Protocol Generator

The N5998A HDMI protocol generator provides patterns required for the sink tests 8–16, 8–21, 8–23, 8–29, 8–31 and, in conjunction with the Agilent TMDS signal generator E4887A, for test 8–25.

Protocol Analyzer

The N5998A's protocol analyzer supports the HDMI compliance tests 7–16 through 7–37, with the exception of tests 7–20, 7–21, 7–22 and 7–39. The protocol analyzer captures up to 4 GB of data.

The N5998A protocol analyzer provides user-controlled execution of individual or multiple protocol/audio/video compliance tests, with clear indication of pass/fail results.

Enhanced Debug Capabilities

With the N5998U-DBG Option, you can import the captured data into the Agilent logic analyzer software for deeper analysis.

Specifications

General characteristics

- Power requirements
 - 100 – 240 V~
 - 300 VA max
 - 50/60 Hz
- TMDS clock output: 3.3 V LVTTTL
- Memory analyzer: 4 GB
- HDMI (input and output): Type A receptacle
- PC controller: USB 2.0
- TMDS clock output: BNC

Ordering Information

N5998A HDMI 1.3 protocol/audio/video analyzer and generator

N5998U-R14 software license upgrade for HDMI 1.4

N5998U-DBG software license for debug exporter

Web Link

www.agilent.com/find/hdmi_analyzer

N4851B
N4861B

Analysis

- 1 to 4 lanes support
- Support for both low power and higher speed, and dynamic tracking of the change in modes
- Track bus mode changes and bi-directional communication
- Image extractor provides bitmap viewing from trace
- Trigger on protocol-specific packets, specific bits within a packet and protocol violations
- Protocol support : DSI (display serial interface), CSI-2 (camera serial interface)

Stimulus

- Deterministic D-PHY, DSI and CSI-2 pattern generation
- Configurable traffic can be generated from the user interface or from CSV files
- Timing control of MIPI D-PHY link layer events
- Bit level to picture level stimulus generation



MIPI D-PHY stimulus and analysis probes

The N4851B MIPI D-PHY acquisition probe and N4861B MIPI D-PHY stimulus probe enable users to perform real-time digital serial analysis and generate real-time digital serial stimulus of the MIPI D-PHY interface.

Both probes support the CSI-2 (camera serial interface) and DSI (display serial interface), enabling users to comprehensively characterize the behavior of controllers as well as display or camera devices.

The Agilent Technologies N4851B acquisition probe and the N4861B stimulus probe operate in conjunction with Agilent 16800 and 16900 Series logic analyzers to provide the digital serial stimulus and acquisition capabilities required to independently debug and test MIPI D-PHY components, or integrate MIPI D-PHY based mobile designs.

Specifications

N4851B MIPI D-PHY 4 lanes digital acquisition probe key specifications

State analysis for MIPI D-PHY compliant devices

- Maximum acquisition speed: 950 Mbps
- 1 to 4 lanes support
- Voltage level support: low power and high speed voltage
- Protocol support: DSI (display serial interface), CSI-2 (camera serial interface)

Monitor device and system operation

- Real-time acquisition of MIPI D-PHY traffic with hierarchical trace displaying capabilities
- Tracks bus mode changes and bi-directional communication
- Image extractor provides bitmap viewing from trace
- Triggers on protocol-specific packets, specific bits within a packet, and protocol violations

Additional capabilities

- LEDs show MIPI D-PHY bus status and error conditions
- Multiple probing solutions, including flying leads and soft touch
- Customize MIPI D-PHY protocol decoding with B4641A protocol development kit

N4861B MIPI D-PHY 3 lanes digital stimulus probe key specifications

MIPI D-PHY compliant digital stimulus

- Maximum stimulus speed: 1 Gbps
- Up to 3 lanes stimulus
- Low power and high speed modes support
- Voltage level support: adjustable low power and high speed voltages

Stimulus probes features

- Deterministic D-PHY, DSI, and CSI-2 pattern generation
- Configurable traffic can be generated from the interface of from CSV files
- Timing control of MIPI D-PHY link layer events
- Captured logic analyzer trace converted to digital stimulus

Methods for creating stimulus

- Custom programming package
- Bit level to picture level stimulus generation
- Captured logic analyzer trace converted to digital stimulus

Ordering Information

Analysis and stimulus solution

To configure a complete MIPI D-PHY digital acquisition and stimulus system, you will need to order or have the following items:

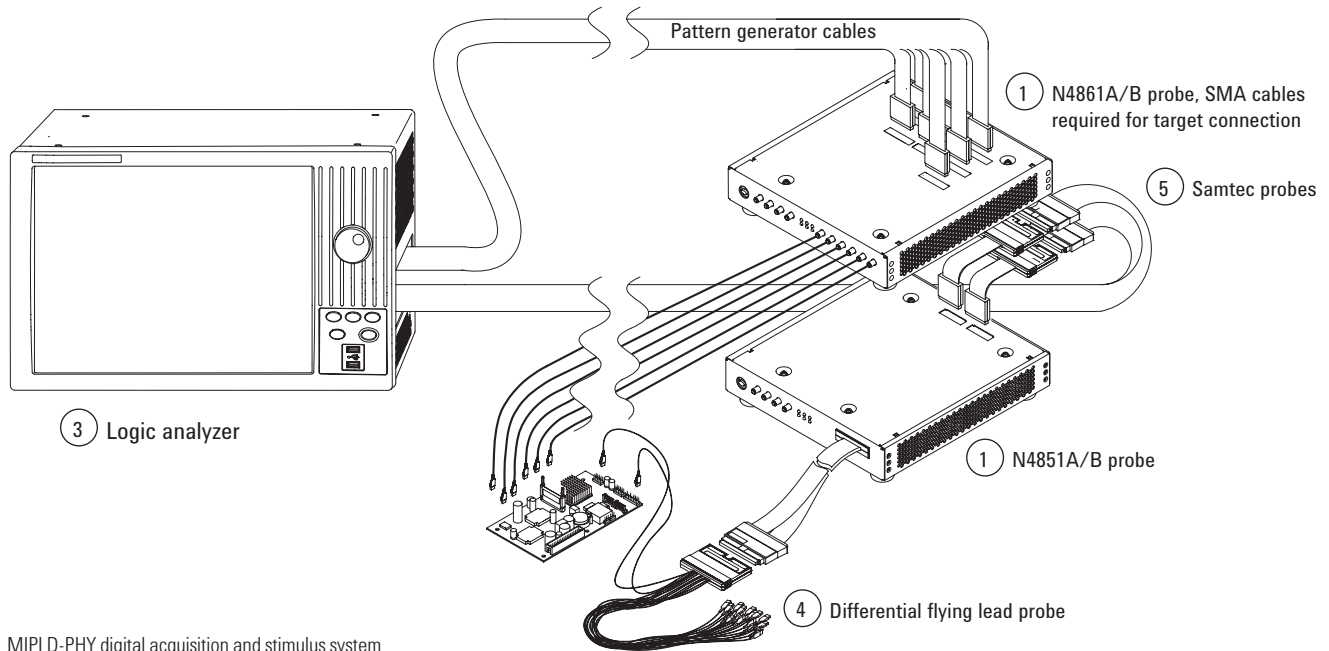

MIPI D-PHY digital acquisition and stimulus system

1. MIPI D-PHY probe	2. Method to create data	3. Logic analyzer with 48-channel pattern generator ²	Probes between the N4851A/B and the...	
			4. Device under test (One of the following for each N4851A/B)	5. Logic analyzer (Two Samtec probes per N4851A/B – one for Tx and one for Rx. Select probe that is compatible with your logic analyzer)
N4861A or N4861B ¹ digital stimulus probe • N4861A-040: Two sets of four 40-inch SMA cables	<ul style="list-style-type: none"> Convert captured logic analyzer trace to stimulus Custom programmatic generation 	16800 Series portables • 16822A – 68 ch • 16823A – 102 ch 16900 Series modular mainframe with at least one each of the following: • 16900 Series module(s) • 16720A pattern generator module	<ul style="list-style-type: none"> E5381A differential flying lead probe E5405A differential pro series soft touch probe E5387A differential soft touch probe 	<ul style="list-style-type: none"> E5385A for logic analyzers with a 40-pin cable connection (16822A, 16823A, 16910/11A) E5378A for logic analyzers with a 90-pin cable connection (1695X modules)
N4851A digital acquisition probe • -010 for node-locked license • -020 for floating (server) license				
N4851B digital acquisition probe				

¹ N4861A/B digital stimulus probe requires an N4851A/B digital acquisition probe to operate and a clock generator, such as the Agilent 33250A

² Compatible with 16800 or 16900 Series logic analyzers with 68 channels or more

Web Link

www.agilent.com/find/csi
www.agilent.com/find/dsi

N9039A
N6141A
W6141A

- RF preselection from 9 kHz to 1 GHz
- CISPR bandwidths (200 Hz, 9 kHz, 120 kHz and 1 MHz)
- CISPR detectors (quasi-peak, peak and average)
- Limit lines and limit margins
- Correction factors for antennas, cables, amplifiers and other devices
- Preselector filter alignment using external signal source
- Built-in limiter for conducted emissions protection
- Preamplifier for greater sensitivity
- 8192 data points for wider scans

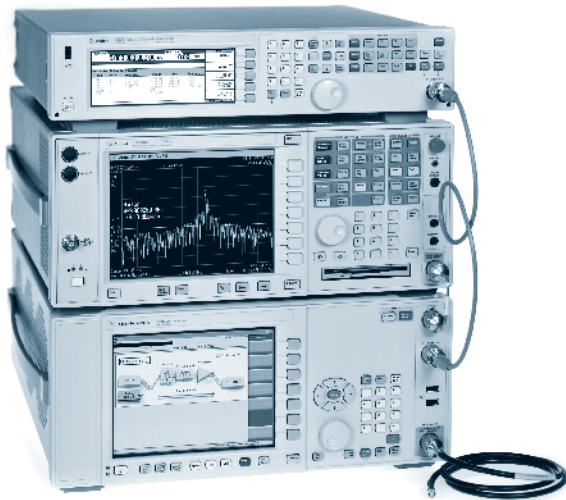

- Easily identify out-of-limit device emissions
- See device emissions typically hidden in the noise
- Differentiate between ambient signals and device emissions
- Maximize signals and compare to regulatory agency requirements
- Continuously monitor signals with bar meters to detect maximum amplitude
- Log and Linear displays
- CISPR 16-1-1 detectors and bandwidths

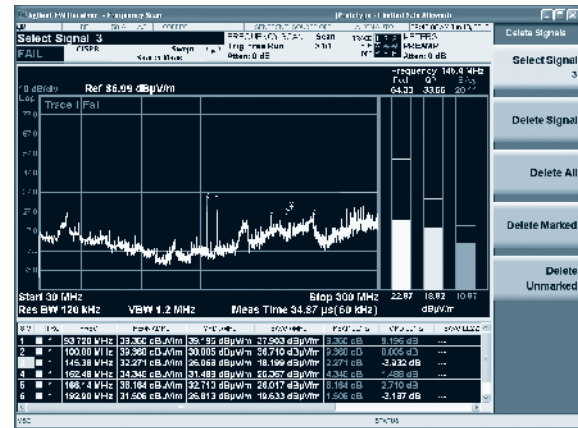

N6141A with meters and signal list

3

EMI Measurement Receiver

Combine the world class performance of the E44xA PSA spectrum analyzer and the N9039A RF preselector and the result is an accurate, fast EMI measurement receiver. This new receiver gives you the confidence that the measurements you make are accurate and repeatable.

Agilent's EMI measurement system offer excellent amplitude and frequency accuracy across the entire band. Delivering 8192 data points per sweep, this system allows you to analyze very broad spans with the resolution recommended by CISPR. In addition, you can quickly switch from bypass to preselected mode for fully compliant measurements.

With the systems excellent amplitude accuracy, you can reduce your margins and increase you pass rate.

Specifications

- Radiated emissions bands sensitivity to 1 GHz: -152 dBm
- Absolute amplitude accuracy ± 1.0 dB, 9 kHz to 1 GHz
- Input VSWR 1.2:1
- Preselected TOI +15 dBm
- Span accuracy @ 100 MHz: 20 kHz typical

Ordering Information

E444xA-239 PSA spectrum analyzer with EMI personality
N9039A RF preselector
N5181A signal generator (required for alignment)

Web Link

www.agilent.com/find/emi

EMC Measurement Application

Perform precompliance conducted and radiated emissions tests to both MIL-STD and commercial requirements. Use the scan table to set up frequency ranges, gains, bandwidths, and dwell time. Mark and delete unwanted signals using the signal list features. This application works with all X-Series signal analyzers.

N6141A/W141A EMC measurement application features

- CISPR 16-1-1 detectors and bandwidths
- Log and Linear display
- Signal list
- Scan table
- Simultaneous detectors
- Measure at marker
- Delta to limit
- Strip chart

Ordering Information

N6141A-2FP fixed perpetual license for N9010A EXA, N9020A MXA, N9030A PXA

N6141A-2TP transportable perpetual license for N9010A EXA, N9020A MXA, N9030A PXA

W6141A-2FP fixed perpetual license for N9000A CXA

Web Link

www.agilent.com/find/n6141a
www.agilent.com/find/w6141a

- Gain unique multi-domain insight into device performance by using 4-port VNA or 4-channel TDR
- Completely characterize the single-ended, differential and mixed mode behavior of your high speed digital interconnect
- Export measurement-based models to industry leading simulators for faster design cycle
- Marker coupling to different traces for comparing multiple views simultaneously
- Trace statistics and trace smoothing for detailed yield information
- XML-based characterization report for saving time writing data sheets

N1930B
N1955B
N1957B
N1958B

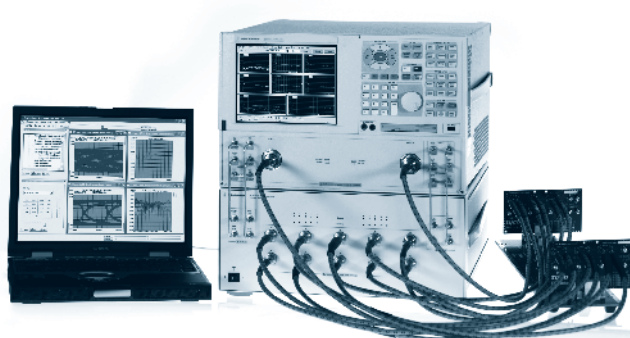
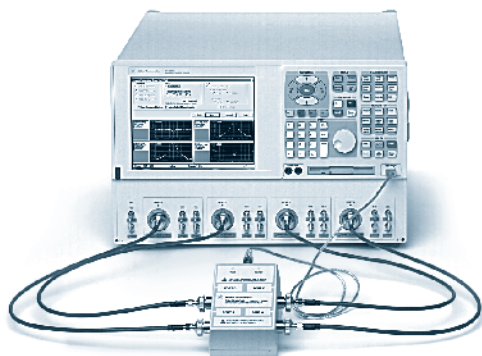

Confidence Based on Accurate Model Extraction and Complete Characterization

The Agilent N1930B series physical-layer test system (PLTS) is the premier signal-integrity solution for designing and validating high-speed digital interconnects. PLTS combines frequency-domain, time-domain and eye-diagram analysis to provide a comprehensive view of device performance. Measurement-based model extraction provides the most accurate models of components, such as printed circuit boards, connectors, backplanes, IC packages, cables and flexible interconnects. Now you can validate interconnect performance of high-speed standards such as advanced telecommunications architecture (ATCA), PCI Express II, serial advanced technology attachment (SATA), infiniband, high density multimedia interface (HDMI), Rapid IO and others.

The PLTS utilizes a four-port vector network analyzer (VNA) or four-channel time domain reflectometer (TDR) with an external PC running a unique signal integrity software analysis tool. This enables the most accurate and comprehensive solution for complete characterization of your high-speed interconnects. With a single setup to your device under test (DUT), you can measure all transmission and reflection terms in both frequency and time domain in all possible modes of operation, including single-ended, differential, common and mixed modes. In addition, the use of co-axial electronic calibration modules reduce the amount of time required for test system calibration by a factor of 30.

PLTS Version 5.5

PLTS version 5.5 has added some very significant capabilities to help R&D signal integrity engineers transition their product into manufacturing and high volume testing. The most time saving feature added is the Test Suites. When new high-speed digital standards are developed such as, Serial ATA, HDMI, and USB 3.0, a compliance document is used to create a final acceptance test plan for each different protocol. With PLTS v5.5, the information in this compliance document can be directly input to create a compliance test suite. This PLTS test suite will allow all pertinent parameters defined by the standard to be tested automatically. This includes all passive device parameters such as differential impedance, differential insertion loss, eye diagram and mode conversion to just name a few. In addition to creating custom test suites, there will also be standard test suites that can be purchased to save even more precious engineering time.

3

Selection Guide for Agilent N1930B Series Physical-Layer Test Systems

Product	N1930A	N1955B	N1957B	N1958B
Description	Physical-layer test system software that controls the system and provides advanced data analysis tools	E8363C PNA and N4420B test set 4-Port/4-Receiver	E8364C PNA and N4421B test set 4-Port/4-Receiver	N5230C PNA-L with built-in test set (pictured above)
Frequency range		10 MHz to 40 GHz	10 MHz to 50 GHz	300 KHz to 20 GHz
Rise time		18 pS	14 pS	35 pS

Web Link

www.agilent.com/find/PLTS

E3238S
N6820E
N6841A
N7105A

- **Fast wideband search and high resolution**
- **Available frequency ranges: 100 kHz to 32 MHz, 20 MHz to 2.7 GHz, 20 MHz to 6 GHz, or up to 26.5 GHz**
- **Optimized signal detection tools provide data only on signals of interest**
- **New energy database simplifies cataloging spectrum survey results**
- **Record time and frequency snapshots**
- **Reconfigure signal detection without programming**
- **Low-cost digital downconverter channels for narrowband signal processing**

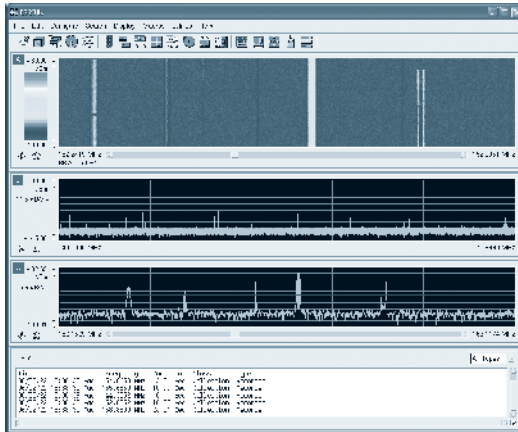

Optimized Software for Signal Survey

Monitoring the RF spectrum requires extremely high speed search for detecting intermittent or short duration signals. Once a signal of interest is detected, high resolution is needed to get characteristics of signals close to larger signals or near the noise floor. Unlike spectrum analyzers which tradeoff resolution bandwidth for scan speed, these signal monitoring solutions have 100 times the scan speed at similar low resolution bandwidths.

The N6820E signal survey software is optimized for use with the high speed RF spectral search hardware choices. Efficiency and productivity in sorting through the spectrum data to identify signals of interest is done with an impressive set of tools. First it limits analysis on signals that exceed an energy threshold. Alarms are used to reduce the data to signals of interest and initiate recording. The universal signal detection lets you re-configure without programming to collect data on the latest radios.

Ordering Information

- N6820E** E3238S signal survey software
- N6820E-103** standard software for Windows
 - N6820E-114** core software for N6841A RF sensor only
 - N6820E-AU1** audio output
 - N6820E-MR1** basic modulation recognition application
 - N6820E-NBR** narrowband recorder
 - N6820E-SSY** RF sensor measurement synchronization
 - N6820E-USD** universal signal detection



Multiple RF Bands and Simultaneous Narrowband Collection in a Modular Package

The N7105A signal monitoring system has ideal size, weight and power for transportable or semi-fixed deployments. It's our newest offering of hardware for signal monitoring covering 20 MHz to 6 GHz. The E3238S is a VXI-based solution with our most comprehensive feature set and frequency coverage up to 26.5 GHz with a spectrum analyzer.



Multiple N6841A RF sensors can be deployed remotely and connected over any standard TCP/IP network to provide close-in signal monitoring and detection – within a building, throughout a city or across a country. Agilent's entire signal monitoring hardware family operates with the N6820E software making a powerful solution for numerous applications.

Ordering Information

- N7105A** signal monitoring system
- N7105A-C02** configured for 2 channels, 6 GHz
 - N7105A-062** adds one dual V/UHF receiver module, 6 GHz
 - N7105A-140** adds one CPU module
 - N7105A-145** adds one FPGA module
- N6841A** RF sensor
- N6841A-GPS** adds GPS capability, includes 3 m cable and active antenna
 - N6841A-SP1** power supply for indoor use
- E3238S** E3238S signal detection and monitoring solutions
- E3238S-030** 20 MHz to 2.7 GHz RF tuner, VXI model E2730B, includes cable kit
 - E3238S-031** 20 MHz to 6.0 GHz RF tuner, VXI model E2731B, includes cable kit
 - E3238S-040** cable kit for PSA as tuner
 - E3238S-050** 5.12 TB, 1U recorder hardware and interface cables
 - E3238S-051** 16 TB, 2U recorder hardware and interface cables
- E9821A** signal processor module for E3238 system
- E9821A-101** add dual G4 processor card with extended RAM
 - E9821A-200** multi-channel digital downconverter card
- N6830A** dual channel HF receiver and 70 MHz IF ADC for E3238 systems, VXI 1-slot C-size

Web Link

www.agilent.com/find/rfsensor
www.agilent.com/find/n6820e

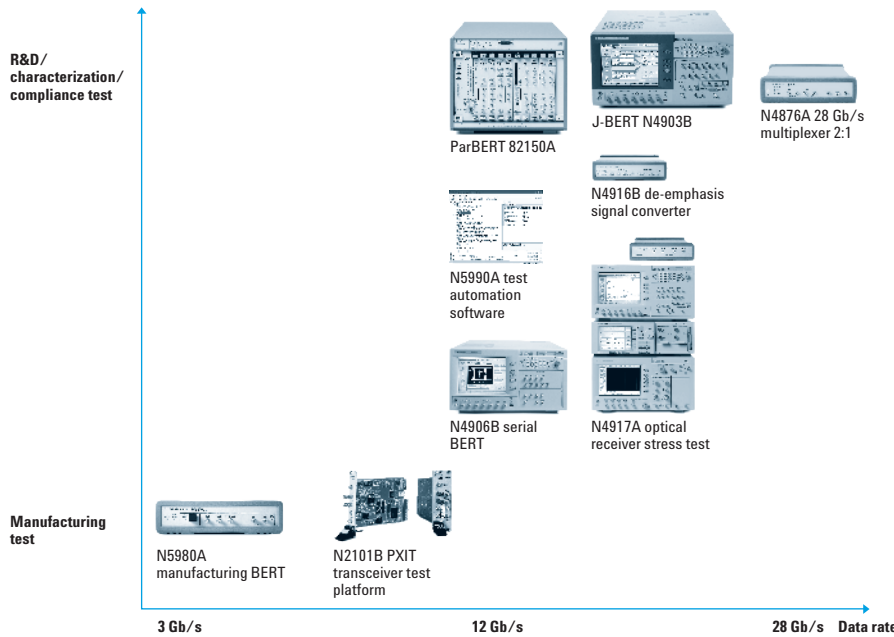

Agilent bit error ratio testers (BERTs) provide efficient and accurate physical layer testing of multi-gigabit interfaces, such as QPI, Hypertransport, PCI Express, SATA, USB, memory interfaces, HDMI, DisplayPort, MIPI, Fibre Channel, 10 Gb Ethernet, 100 Gb Ethernet, XFP/XFI, SP/SFP+/SFI, CEI, and PON.

BERTs are used to measure the BER, the fundamental metric of transmission quality of a transmission link. BER is defined as the ratio of the number of erroneous bits divided by the number of transmitted or received bits. Therefore BERTs are used to measure the receiver jitter tolerance, where the BERT pattern generator provides the stressed pattern signal for the receiver while the analyzer measures the BER. Another important measurement is accurate measurement of total jitter, because BERT analyzers sample 100% of transmitted bits.

Agilent BERTs can be used in volume manufacturing test, for standard compliance test of receivers, and for R&D characterization of next generation gigabit interfaces.

N4903B
N4906B
N5980A
81250
N2101B
N4916B
N4917A
N4876A
N5990A

BERT Overview

Model	Type	Data rate	Application	Key features	Page
N4903B	Serial BERT	Variable, 150 Mb/s* to 7/12.5/14.2 Gb/s	R&D	High-performance serial BERT with built-in, calibrated jitter sources (PJ1, PJ2, SJ, RJ, BUJ, SSC, S.I., ISI), automated jitter tolerance tests, half-rate clock with variable duty cycle, 2nd output channel, built-in CDR with tunable loop bandwidth see www.agilent.com/find/n4903	120
N4906B	Serial BERT	Variable, 150 Mb/s* to 3.6/12.5 Gb/s	R&D	General purpose serial BERT with excellent price/performance ratio for telecom device testing, pattern and PRBS, true differential inputs, optional CDR, and analyzer measurement suite see www.agilent.com/find/n4906	122
N5980A	Serial BERT	Fix, 125 Mb/s to 3.125 Gb/s	Manufacturing	Electrical and optical transceiver test, remote control, SMA connectors or SFP plug-in, PRBS and comma characters, built-in CDR, differential inputs, small size see www.agilent.com/find/n5980	123
81250A	Modular BERT	Variable, 20.834 Mb/s to 13.5 Gb/s	R&D	Multi-channel, modular and scalable BERT platform, user-definable pattern and PRBS sequences, programmable output and timing per channel, external delay control input, analyzer measurements suite see www.agilent.com/find/81250	124
N2101B	Modular BERT	Fix, 155 Mb/s to 10.3125 Gb/s	Manufacturing	PXIT modular transceiver test platform is tailored for manufacturing test of optical gigabit transceivers, including parallel optics. Platform offers DCA, synthesizer, pattern generator and BERT modules see www.agilent.com/find/n2101	126
N4916B	De-emphasis	Variable, 660 Mb/s to 10.5 Gb/s	R&D	Emulates transmitter de-emphasis with up to 4 taps, adjustable de-emphasis level up to 12 dB per cursor, transparent to jitter, DC-coupled see www.agilent.com/find/n4916	121
N4917A	Stress-conditioning hardware, accessories, control software	10 GbE, 10G FC and variable up to 12.5 Gb/s	R&D	Calibrated injection of OMA, ER, and VECP, compliant to 10 GBASE -ER, -LR, -SR, 10G FC, automated BER vs. OMA measurement see www.agilent.com/find/n4917	124
N4876A	Multiplexer 2 : 1	Variable, 1.25 to 28.4 Gb/s	R&D	Extends pattern generator data rate to 28.4 Gb/s by multiplexing two generator channels from J-BERT or ParBERT see www.agilent.com/find/n4876	121
N5990A	Software	n/a	R&D	Automated calibration, compliance and characterization tests for multiple serial bus standards, such as SATA, PCIe, USB, HDMI, MIPI, DP see www.agilent.com/find/automation	

* with external clock

Web Link

www.agilent.com/find/berts

N4903B

- Operates from 150 Mb/s to 7 Gb/s, 12.5 or 14.2 Gb/s
- Built-in calibrated and compliant jitter sources for RJ, PJ1, PJ2, SJ, BUJ
- Interference channel with sinusoidal interference and switchable ISI traces
- Automated jitter tolerance sweep
- Second output channel with independent PRBS and pattern memory (32 Mbit)
- Built-in tunable CDR
- Half-rate clock with variable duty cycle, sub-rate clock outputs

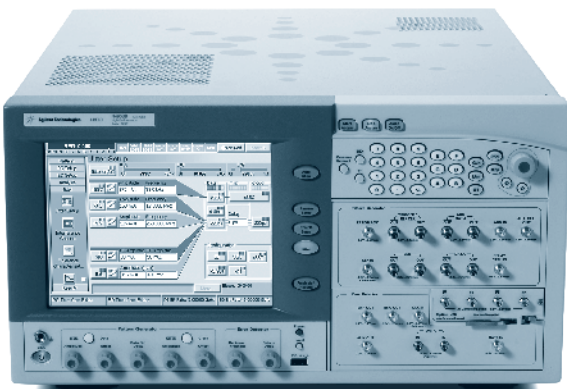

J-BERT N4903B high-performance serial BERT

Complete Receiver Jitter Tolerance

J-BERT provides built-in and calibrated jitter sources for the most accurate jitter tolerance testing of receivers used in many popular multi-gigabit serial bus interfaces.

It is used by R&D and test engineers in the semiconductor, computer, and communication industry to characterize new designs and verify standard compliance.

J-BERT supports testing of embedded and forwarded clock architectures for data rates up to 14.2 Gb/s.

Long-term Investment

J-BERT is configurable for today's test and budget needs but allows retrofit of all options when test needs change.

Key Applications:

- Receiver jitter tolerance
- PCI Express
- USB3, SATA, SAS
- Forwarded clock interfaces: QPI, Hypertransport
- DisplayPort
- Fibre Channel
- XFP, SFP, SFP+
- 10 GbE, XAUI
- 100 GbE (10 x 10 Gb/s)
- Backplanes: CEI, 10 GBASE-KR, 100 GBASE-KR4

Specifications

Pattern generator:

- Operation range: 620 Mb/s¹ to 7 Gb/s (Option C07 or G07), to 12.5 Gb/s (Option C13 or G13), to 14.2 Gb/s (Option G13 + D14 or C13 + D14)
- Data outputs: 1 or 2 (Option 002), differential or single-ended
- Output amplitude: 0.1 to 1.8 V_{pp}
- Jitter: < 9 ps pp
- Transition time: < 25 ps (10 to 90% and ECL levels)
- Cross point adjust: 20 to 80%
- Pattern: PRBS 2ⁿ-1, n = 7, 10, 11, 15, 23, 31
- Memory: 32 Mbit and pattern sequencing (up to 120 blocks)
- Delay control input: 220 ps @ 1 GHz for external jitter injection

Jitter tolerance test

- Built-in, calibrated jitter sources (Option J10): RJ up to 15.7 ps rms @ 1 GHz, PJ1+2 up to 620 ps @ 300 MHz, SJ multiple UIs up to 5 MHz, BUJ up to 220 ps, according CEI
- SSC (Option J11): triangular and arbitrary modulation, up to 5000 ppm @ 0.1 to 100 kHz
- Interference channel (Option J20): ISI by switchable board traces, sinusoidal interference (vertical eye closure) common and differential mode up to 400 mV @ 3.2 GHz

Error detector

- External clock: 150 Mb/s to 7 Gb/s (Option C07) or 12.5 Gb/s (Option C13)
- Data input: 1, differential or single-ended
- Delay adjust: ±0.75 ns
- Clock recovery: always included, variable loop bandwidth 500 kHz to 12 MHz (JTF)
- Sensitivity: < 50 mV
- Measurement suite:
 - BER, accumulated, interval; symbol/frame error ratio (Option A02); bit recovery mode (Option A01); pattern capture
 - BERT scan, "bathtub" curve including RJ, DJ, TJ
 - Output level, Q-factor, eye diagram with BER contour and eye masks
 - Fast eye mask, spectral jitter, error location capture, fast TJ

Ordering Information

N4903B high-performance serial BERT. Includes six 50 Ohm resistors, ten adapters 3.5 to 2.4 mm, USB cable, Agilent I/O library

N4903B-C07/C13 BERT with max. data rate 7 Gb/s/12.5 Gb/s

N4903B-G07/G13 pattern generator with max. data rate 7 Gb/s/12.5 Gb/s

N4903B-D14 data rate extension for pattern generator to 14.2 Gb/s

N4903B-002 PRBS and pattern on aux data output (2nd output channel)

N4903B-003 half-rate clock with variable duty cycle

N4903B-J10 jitter sources (PJ1, PJ2, SJ, RJ, sRJ, BUJ)

N4903B-J11 SSC, residual SSC

N4903B-J12 jitter tolerance compliance suite

N4903B-J20 interference channel

N4903B-A01 bit recovery mode

N4903B-A02 SER/FER analysis

N4903B-UAB upgrade from N4903A

All options are upgradeable

Recommended accessories:

N4910A 2.4 mm matched cable pair

N4915A-009 short clock cable 2.4 mm to SMA

N4915A-008 short cable kit for ISI ports

15442A four SMA cables

¹ 150 Mb/s when using external clock source

Web Link

www.agilent.com/find/n4903

- Generates 4-tap adjustable de-emphasis
- Data rates up to 10.4 Gb/s, over-programming up to 14.2 Gb/s
- Tolerates unbalanced patterns
- Transparent for timing jitter
- Small size
- Operation via J-BERT N4903B user interface or as stand-alone
- Optional clock multiplier for analyzing forwarded clock devices



N4916B 4-tap de-emphasis signal converter with optional clock multiplier

N4916B De-Emphasis Signal Converter with optional Clock Multiplier

Accurately Emulate De-Emphasis

The de-emphasis technique is used in many high-speed serial bus interfaces to compensate for signal distortions caused by the transmission of multi-gigabit electrical signals over PC board traces.

The N4916B de-emphasis signal converter enables R&D and test engineers to accurately emulate transmitter de-emphasis with adjustable 4-tap de-emphasis levels, while being transparent to jitter even on non-balanced pattern streams. It can also be used to compensate for distortions caused by cables, fixtures or test boards in the test set up.

Applications Using De-Emphasis (or Pre-Emphasis):

PCI Express, USB3, 10 GBASE-KR, 40 GBASE-KR4, QPI, Hypertransport, memory buses, or other SERDES operating above 8 Gb/s.

Analyze Error, Jitter or Eye Performance of Devices Using Half-Rate Clocks

Half-rate clocks are used in some serial bus interfaces such as QPI and Hypertransport, or memory buses. By using the N4916B's clock multiplier (Option 001), a full-rate clock for the analyzer of J-BERT N4903B is provided, to accurately characterize the error, eye, jitter performance without using a CDR.

Specifications

De-emphasis

- Data rate: 660 Mb/s to 10.5 Gb/s, overprogramming up to 14.2 Gb/s
- Pre-cursor: 0 to +12.0 dB/0.1 dB resolution
- Post-cursor 1: 0 to -12.0 dB/0.1 dB resolution
- Post-cursor 2: 0 to -8.0 dB/0.1 dB resolution
- De-emphasis output: 50 Ω differential, DC coupled
- Output amplitude: 100 to 700 mV single ended; 200 mV to 1400 mV differential; voltage window ±2 V

Clock multiplier

- Input frequency range: 1 to 7.5 GHz, duty cycle 45 – 55%
- Multiplier factors: 1, 2

Ordering Information

N4916B 4-tap de-emphasis signal converter

N4916B-001 clock multiplier

N4915A-010 matched cable pair for connecting N4916B with J-BERT N4903B

Web Link

www.agilent.com/find/n4916

- Extends pattern generator data rate to up to 28.4 Gb/s
- Excellent output performance
- Transparent for timing jitter
- Small size
- Operation via J-BERT N4903B user interface or as stand-alone



N4876A 28 Gb/s multiplexer 2:1

N4876A 28.4 Gb/s Multiplexer 2 : 1

Accurate Characterization up to 28 Gb/s

The N4876A 28 Gb/s multiplexer allows to extend the pattern generator data rate of the J-BERT N4903B and ParBERT 81250A up to 28.4 Gb/s. Design and test engineers in the semiconductor, communications, storage and computer industry can now accurately characterize the next generation of serial interfaces. N4876A offers excellent output performance to optimize design margins, it is transparent to jitter, so when using it with the J-BERT N4903B, calibrated RJ and PJ can be generated. The small size allows locating the device under test closely to the output.

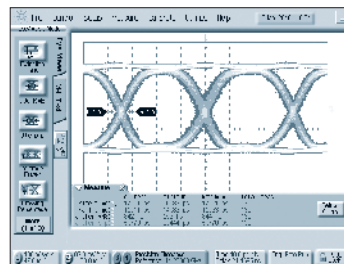

28.4 Gb/s PRBS output signal of multiplexer N4876A

Target Applications:

- IEEE 802.3 ba 100 GBASE-LR4, -ER4 interfaces operating at data rates of 25.78125 Gb/s
- OIF CEI backplanes operating between 19.9 and 28 Gb/s
- T11 16x or 32x Fibre Channel
- Clean generator for transmitter test
- Stressed generator for receiver tolerance testing
- Clock/2 jitter injection

Specifications

- Output data rate: 1.25 to 27.0 Gb/s (28.4 Gb/s when using J-BERT N4903A Option D14)
- Output amplitude: 0.05 to 1.800 V in a -2 to +3 V window
- Intrinsic jitter: 1 ps rms typ. for clock pattern
- Transition time: 10 ps typ. (20 – 80%)
- Crossing point: 20 to 80%
- Clock/2 jitter: 45 to 55% shorter/longer even bits than odd bits
- Output: differential or single-ended, 50 Ohm

Ordering Information

N4876A-001 28 Gb/s multiplexer 2 : 1

N4915A-011 matched cable triple for connecting N4876A with J-BERT N4903B

Web Link

www.agilent.com/find/n4876

N4906B

- Excellent price/performance ratio
- Variable frequency up to 3.6 or 12.5 Gb/s
- < 25 ps transition time
- < 50 mV pp input sensitivity
- Fast eye mask measurement for pass/fail testing (Option 101)
- True differential data generation and analysis capability (Option 101)
- Enhanced measurement suite (Option 101)
- Integrated clock data recovery (Option 102)
- Small form factor saves bench or rack space
- LAN, USB, GPIB for remote control
- Compatibility with existing remote commands, e.g. Agilent 71612, 86130A Series and N4900 Series
- Applications: manufacturing test, Telecom transceivers such as SONET/SDH Fibre Channel, 10 GbE, XFP/XFI, PON-OLT's and high-speed serial computer buses

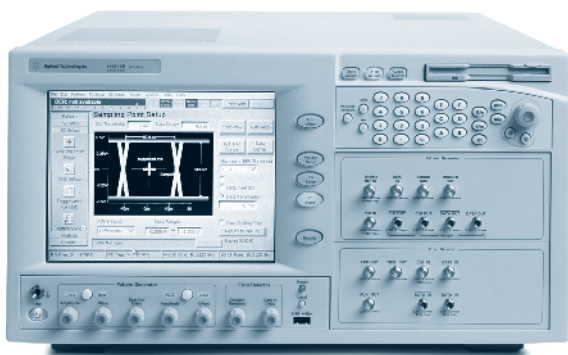

3

The serial BERT N4906B is a general-purpose bit error ratio tester designed for testing high-speed digital communication components and systems.

It is ideal for cost-effective manufacturing and telecom device testing.

It offers a 3.6 or 12.5 Gb/s pattern generator and error detector with excellent price/performance ratio.

Transition times < 25 ps allow precise measurements.

The analyzer can be configured with CDR to test clockless interfaces and with true differential inputs to test LVDS and other differential interfaces.

The compact size of the N4906B saves rack space; LAN, USB and GPIB interfaces allow smooth integration into automated test environments.

For bench users the N4906B serial BERT offers an intuitive user interface with state-of-the-art Windows-XP based touch-screen.

Deeper insight into the device's performance can be obtained with the enhanced measurement suite. It offers many valuable signal analysis tools, such as BERT Scan (so-called bathtub curves) with total jitter and its separation into RJ and DJ, eye contours, spectral jitter decomposition and more.

Specifications

Pattern generator

- Operation range:
 - 9.5 to 12.5 Gb/s (Option 012)
 - 150 Mb/s to 12.5 Gb/s (Option 102)
 - 150 Mb/s to 3.6 Gb/s (Option 003)
- Data output: 1, differential or single-ended
- Output amplitude: 0.10 to 1.8 V in 5 mV steps
- Jitter: 9 ps pp typical
- Transition time: < 25 ps (10 to 90% and ECL levels)
- Cross point adjust: 20 – 80%
- Pattern:
 - PRBS 2ⁿ-1, n = 7, 10, 11, 15, 23, 31
 - User-definable memory: 32 Mbit

Error detector

- Operation range:
 - 9.5 to 12.5 Gb/s
 - 150 Mb/s to 12.5 Gb/s (Option 102)
- Data input: 1, single-ended or differential (Option 101 or 003)
- Delay adjust: 1.5 ns
- Clock data recovery (Option 102):
 - 1.058 to 1.6 Gb/s: loop bandwidth 1 MHz typ.
 - 2.115 to 3.2 Gb/s: loop bandwidth 2 MHz typ.
 - 4.23 to 6.4 Gb/s: loop bandwidth 4 MHz typ.
 - 9.9 to 10.9 Gb/s: loop bandwidth 8 MHz typ.
- Sensitivity: < 50 mV
- Measurements:
 - BER
 - Fast eye mask measurement with pass/fail (Option 101)
 - BERT scan with RJ/DJ separation (Option 101)
 - Fast total jitter (Option 101)
 - Spectral jitter decomposition (Option 101)
 - Eye contour (Option 101)
 - Output level (Option 101)
 - Error location capture (Option 101)

Accessories

N4910A 2.4 mm matched cable pair

N4915A-001 One 47 ps transition time converter

Ordering Information

N4906B-012 serial BERT 12.5 Gb/s; pattern generator and error detector; 4 x 50 Ω terminations; 6 x 2.4 mm to 3.5 mm APC converter; no cables included

N4906B-101 differential analysis, fast eye mask and enhanced measurement suite (only applicable with N4906B-012)

N4906B-102 extension to full frequency range 150 Mb/s to 12.5 Gb/s + clock data recovery (only applicable with N4906B-012)

N4906B-003 serial BERT 3.6 Gb/s pattern generator and error detector; 4 x 50 Ω terminations; 6 x 2.4 to 3.5 mm APC converter; no cables included

Web Link

www.agilent.com/find/n4906

- Standard measurements at rates between 125 Mb/s and 3.125 Gb/s
- Generation of pseudo random bit sequence (PRBS) polynomials and a K28.5 pattern at low voltage differential signal (LVDS) or emitter coupled logic (ECL) levels
- Flexible connections to the device under test via 3.5 mm differential electrical coax connectors and/or standard optical SFP module plug-ins
- Optical and electrical error injection once or at selectable bit error ratio (BER)
- Analysis of gated BER with display of the absolute number of errors and selectability of gate time
- Dramatically simplified transceiver measurements that provide just the essential tests via the one page graphical user interface (running on an external Windows XP PC via a USB 2.0 interface)
- Full programmability of all graphical user interface features from another software program, making automation in manufacturing an easy task



N5980A manufacturing serial BERT

The Agilent N5980A 3.125 Gb/s serial BERT is ideal for manual or automated manufacturing test of electrical and optical devices running at speeds between 125 Mb/s and 3.125 Gb/s. It addresses all common standard speeds via selectable bit rates.

Easy-to-Use and Cost Efficient

The software user interface has one standard or one advanced screen to ensure intuitive use for operators. It makes the instrument easy to use and easy to learn.

Twice the Measurement Throughput

By using both the electrical and optical (SFP) interfaces concurrently, you can double your measurement throughput (electrical in/optical out and vice versa).

Automation Made Easy

The remote programmability of the user interface, using SCPI – syntax, makes it simple to integrate the N5980A into other programs.

PRBS, K28.5 Pattern or Clock Generation and Integrated Clock Data Recovery

The N5980A can generate standard PRBS polynomials, K28.5 ('Comma') characters and different sub-rate clocks (/2 to /20). It can also inject errors with an adjustable error ratio. The receiver has a clock-data recovery (CDR) built-in and differential inputs (SMA) for signals from 50 mVpp to 2 Vpp amplitude.

Standard (SFP) Optical Module Plug-In

The instrument has a standard SFP – female connector. This enables all different kind of user-selectable optical modules e.g for multi-mode/single-mode fiber at 850, 1310 and 1550 nm for the test set-up.

Small Size

Its very small size allows the N5980A to fit on any bench and in any automated setup.

Specifications

Data rates

- Fast Ethernet: 125 Mb/s
- OC-3: 155.52 Mb/s
- OC-12: 622.08 Mb/s
- OC-48: 2.48832 Gb/s
- OC-48 with FEC: 2.66606 Gb/s
- 1 x FC: 1.0625 Gb/s
- 2 x FC: 2.125 Gb/s
- 1 x Gigabit Ethernet: 1.25 Gb/s
- XAUI: 3.125 Gb/s
- Accuracy: ± 50 ppm

Operating system: the software supplied runs on Windows 2000 or XP with .NET v2.0, by a USB 2.0 interface

Pattern generator

- Pattern:
 - PRBS: 2^7-1 , $2^{15}-1$, $2^{23}-1$, $2^{31}-1$
 - Data pattern: K28.5
 - Clock pattern: data rate divide by n, n = 2, 4, 8, 10, 16, 20
 - The pattern can be individually adjusted for pattern generator electrical out and optical out
- Error injection:
 - Fixed electrical and optical error inject:
 - Fixed error ratios of 1 error in 10^n bits, n = 3, 4, 5, 6, 7, 8, 9
 - Single error injection
 - Separate error ratios can be adjusted for pattern generator electrical out and optical out
- Pattern generator electrical out: a differential electrical output is provided on the front-panel

Output amplitude

- ECL:
 - 850 mVpp typ., single-ended
 - 1700 mVpp typ., differential
- LVDS:
 - 400 mVpp typ., single-ended
 - 800 mVpp typ., differential
- Jitter:
 - 0.05 UI typ. @ OC-12
 - 0.08 UI typ. @ GbE
 - 0.15 UI typ. @ OC-48
- Pattern generator optical out:
 - A standard SFP housing is provided
 - Minimum number of insertion/deinsertion cycles: 200

Error detector

- A differential electrical input is provided on the front-panel
- Data rate is the same as pattern generator
- Pattern: PRBS: 2^7-1 , $2^{15}-1$, $2^{23}-1$, $2^{31}-1$
- Data input: differential AC coupled
- Max. input amplitude:
 - 1 Vpp, single-ended
 - 2 Vpp, differential
- Clock data recovery: internal CDR
- Impedance: 100 Ohms nominal
- Sensitivity: < 50 mV
- Synchronization: automatically on level, polarity, phase, bit and pattern
- Operating system: the software supplied runs on Windows 2000 or XP with .NET v2.0, by a USB 2.0 interface

Dimensions

- 228 mm (W) x 59 mm (H) x 246 mm (D) (Bench top dimensions)

Ordering Information

N5980A 3.125 Gb/s serial BERT

Web Link

www.agilent.com/find/n5980

81250
E4805B
E4808A
E4809A
E4832A
E4835A
E4838A
E4861B
E4862A
E4863A
N4872A
N4873A
N4874A
N4875A

- Different modules covering a range of data rates from 333 kb/s to 13.5 Gb/s
- Up to 66 synchronous pattern generator and analyzer channels
- Powerful pattern sequencer providing looping and branching on events enabling control of complex tests and devices
- PRBS/PRWS and memory based patterns up to 64 Mb
- Delay control input for jitter generation
- Error detector modules featuring individual CDR
- Measurement suite

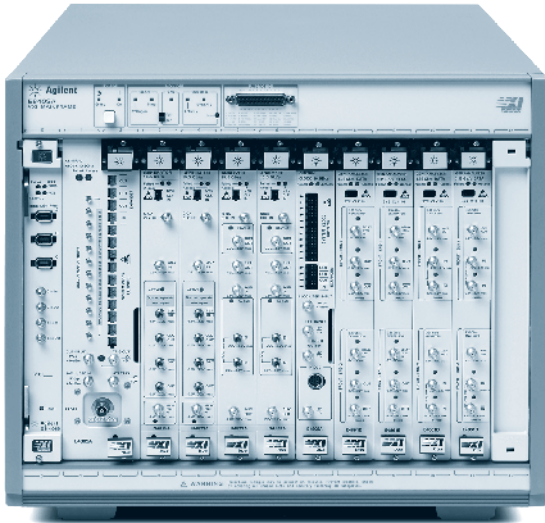

81250 ParBERT

The ParBERT 81250 parallel bit error ratio tester provides extremely fast parallel BER testing for high-speed digital communication ports, components, chips or modules. ParBERT is a modular, flexible and scalable platform with comprehensive software and measurement suite suited for many applications in the semiconductor, computer, storage, communications and consumer industry.

Applications

- R&D characterization and compliance testing of single and multi-lane receiver and transmitter ports
- Manufacturing test of multiple devices in parallel
- MUX, DeMUX testing
- A/D, D/A converter testing
- Multi-lane computer buses: PCI Express, HDMI, MIPI, Fibre Channel, CPU-frontside buses such as Hypertransport, QPI, memory buses such as AMB, SMI
- Communication interfaces: PON ONU/OLT, IEEE 802.3 xx (10 GbE, 40 GbE, 100 GbE), XAUI, SONET/SDH, SFI-4, SFI-5, CEI backplanes

Powerful Pattern Sequencing

Run complex tests with a variety of test patterns in one shot without stopping the instrument for pattern download is enabled through the powerful ParBERT 81250 pattern sequencer with its up to five nested loop levels and branching on external and internal events or upon programming command.

Configurable with Multiple Bit Rates and Channels

Modules for four speed-classes are available for the ParBERT 81250 System that cover data generation and analysis from 333 kb/s up to 13.5 Gb/s. Users can configure the number of analyzer and generator channels independently. Each channel can be programmed with individual level, pattern and timing parameters. Once purchased in a certain configuration ParBERT 81250 can easily be extended to fit future needs protecting investment over a long timeframe.

Real-Time Analysis of Multiple Lanes

The ParBERT analyzers can automatically synchronize the incoming data stream. ParBERT offers a comprehensive measurement suite:

- BER measurement (one-/zero errors, accumulated errors...)
- Fast eye mask measurement (mask test with pass/fail)
- DUT output timing measurement (RJ, DJ, TJ, phase margin)
- Spectral decomposition of jitter (spectral jitter analysis)
- DUT output level measurement (high/low level, amplitude, Q-factor)
- Eye opening (3-dimensional eye analysis voltage-time-BER)

Receiver Jitter Tolerance

The ParBERT generator modules with 13.5/7/3.35 Gb/s data rates offer jitter injection capabilities via the external delay control input. This allows in depth receiver jitter tolerance analysis.

Specifications

Clock module

	E4805B	E4808A	E4809A
Frequency range	1 kHz to 2.7 GHz	170 kHz to 10.8 GHz	20.8 MHz to 13.5 GHz
Resolution	1 Hz	1 Hz	1 Hz
Accuracy	±50 ppm with internal PLL reference	±50 ppm with internal PLL reference	±50 ppm with internal PLL reference
Clock jitter	< 10 ps rms (5 ps typ.)	< 10 ps rms (5 ps typ.)	~2 ps rms
Compatible data modules	E4832A/E4861A*	E4832A/E4861A*/E4861B/E4868B*/E4869B*/E4810A*/E4811A*	E4832A/E4861B/E4810A*/E4811A*/N4872A/N4873A/N4874A/N4875A

* Discontinued modules

Data modules

	E4832A	E4861B
Maximum data rate	675 Mb/s	3.35 Gb/s
Front end slots per module	4	2
Memory depth per channel	Up to 2 Mb	Up to 16 Mb
Segments PRBS, PRWS	User defined patterns and PRBS 2 ⁿ -1, n=7, 9, 10, 11, 15, 23, 31	User defined patterns and PRBS 2 ⁿ -1, n=7, 9, 10, 11, 15, 23, 31

Auto-synchronization

On PRBS and memory based data by:
 – Bit synchronization with or without automatic phase alignment
 – Automatic delay alignment around the start sampling delay

Usable front ends	E4838A, E4835A	E4862A, E4863B
-------------------	----------------	----------------

Data generator front ends (FE) and modules (M)

	E4838A (FE)	E4862B (FE)	N4874A (M)	N4872A (M)
Maximum data rate	675 Mb/s	3.35 Gb/s	7 Gb/s	13.5 Gb/s
Outputs	1, differential or single-ended	1, differential or single-ended	1, differential or single-ended	1, differential or single-ended
Data format	RZ, R1, NRZ, DNRZ	NRZ, DNRZ, RZ, R1	NRZ, DNRZ	NRZ, DNRZ
Transition times	0.5 – 4.5 ns (0.35 ns typ.) @ ECL (10 – 90%)	< 75 ps (60 ps typ.) (20 – 80%)	< 25 ps (10 – 90%)	< 25 ps (10 – 90%)
Amplitude/resolution	< 0.1 to 3.5 Vpp/10 mV	—	0.1 to 1.8 Vpp/5 mV	0.1 to 1.8 Vpp/5 mV
Memory depth per channel	see data module above		Up to 64 Mb	Up to 64 Mb
Segments PRBS, PRWS	see data module above		User defined patterns and PRBS 2 ⁿ -1, n=7, 10, 11, 15, 23, 31 (HW based)	

Data analyzer front ends (FE) and modules (M)

	E4835A (FE)	E4863B (FE)	N4875A (M)	N4873A (M)
Maximum data rate	675 Mb/s	3.35 Gb/s	7 Gb/s CDR around 1/2/4 Gb/s	13.5 Gb/s CDR around 1/2/4/10 Gb/s
Inputs	2, differential or single-ended	1, differential or single ended	1, differential or single ended	1, differential or single ended
Impedance	50 Ω single-ended 100 Ω differential	50 Ω single-ended 100 Ω differential	50 Ω single-ended 100 Ω differential	50 Ω single-ended 100 Ω differential
Input threshold	–2.0 to +4.5 V	–2.0 to +3.0 V	–2.0 to +3.0 V	–2.0 to +3.0 V
Sensitivity	—	—	50 mV	50 mV

Auto-synchronization

On PRBS and memory based data by:
 – Bit synchronization with or without automatic phase alignment
 – Automatic delay alignment around the start sampling delay

Web Link

www.agilent.com/find/parbert

N2099A
N2100B
N2101B
N2102B

N2099A PXI synthesizer

- Two frequency ranges available between 4.25 and 11.5 GHz
- Dual RF outputs
- 10 MHz reference output
- Excellent phase noise performance

N2102B PXI pulse pattern generator

- PRBS generations $2^n - 1$, ($n = 7, 9, 11, 15, 23, 31$)
- K28.5, K28.7, CR PAT and user defined patterns
- Single error and error rate injection
- Differential data output

N2101B PXI bit error ratio tester

- PRBS generations $2^n - 1$, ($n = 7, 9, 11, 15, 23, 31$)
- K28.5, K28.7, CR PAT and user defined patterns
- Fixed internal clock rates from 622 Mb/s to 8.5 Gb/s
- Any rates from 155 Mb/s to 10.3125 Gb/s using external clock
- Bathtub jitter measurement capability

N2100B PXI digital communications analyzer (DCA)

- Eye diagram, jitter and mask testing
- High throughput measurement engine
- 750 to 1650 nm, multimode and single-mode fiber input
- 10GE and PON filters available
- 4 Bessel Thomson filters



N2099A

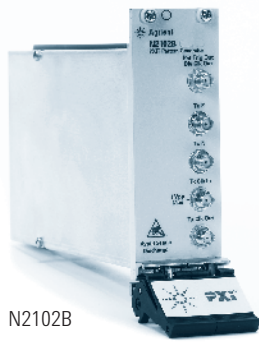

N2102B



N2101B

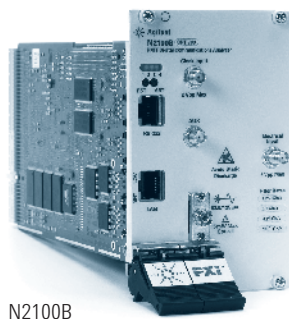

N2100B

Agilent offers four cost effective PXI modules that are particularly useful to optical transceiver manufacturers. The modular PXI platform allows flexible instrument configurations in a single mainframe. Either a PXI embedded controller or a PXI interface card to connect to an external PC is required.

The N2099A PXI Synthesizer combined with the N2102B PXI pulse pattern generator is a complete source to stimulate the transceiver. For optical and electrical eye diagram analysis the N2100B PXI digital communications analyzer can be included in the system.

The N2101B PXI BERT includes the same pattern generation functionality as the N2102B PPG. In combination with the N2100B DCA and the N2099A PXI synthesizer, it can measure all required transceiver test parameters.

All four modules come with accompanying software that makes programming simple and provides control from Windows PCs through a graphical user interface.

N2099A PXI Synthesizer

The N2099A Synthesizer is a 2-slot module that covers a 2 GHz tuning range and is available at two center frequencies 5.25 and 10.5 GHz.

N2102B PXI Pulse Pattern Generator

The N2102B PXIT pattern generator is a 2-slot PXI module capable of generating a number of industry standard patterns, with very low jitter, at rates from 622 Mb/s to 10.3125 Gb/s. The N2102B requires an external clock source, such as the N2099A PXI synthesizer.

N2101B PXI Bit Error Ratio Tester

The N2101B PXI 10.3125 Gb/s BERT consists of a clock source, data pattern generator and error detector within a 3-slot PXI module. The N2102B requires an external clock source, such as the N2099A, at bit rates above 8.5 Gb/s.

N2100B PXI Digital Communications Analyzer (DCA)

The N2100B PXIT DCA implements a patented coherent vector under-sampling technique which combines the capabilities of a real time scope with the bandwidth of a sampling scope. It is ideal to characterize transmitters from 155 Mb/s to 10.3125 Gb/s.

Specifications

N2099A PXI synthesizer

- Output frequency (center): 5.25 and 10.5 GHz
- Tuning range: ± 1.0 GHz
- External reference Osc. output Freq (TCXO): 10 MHz

N2102B PXI pulse pattern generator

- Bit rate operation: 622 Mb/s to 10.3125 Gb/s
- Rise/fall time (20% – 80%): 25 ps (max), 22 ps (characteristic)
- Output intrinsic jitter: 2.5 ps RMS (max), 1.5 ps RMS (characteristic)

N2101B PXI bit error ratio tester

- Output intrinsic jitter: 2.5 ps RMS (max), 1.5 ps RMS (characteristic)
- Rise/fall time (20% – 80%): 25 ps (max), 22 ps (characteristic)
- Output range: 250 mV – 1 V single ended
- Error detection input range: 50 mV – 2 V differential

N2100B PXI digital communications analyzer (DCA)

- Sample rate: 160 MS/s
- Points per acquisition: 1024
- Max. number of acquisitions: 1024
- Pattern acquisition length: 2047 bits
- Clock recovery: < 2.7 Gb/s
- Clock input: 10 MHz to 11.318 GHz (characteristic), 0.5 to 1 V pp
- Electrical input
 - Bandwidth: 12 GHz (characteristic)
 - RMS noise: 2.5 mV RMS (max) 1.3 mV RMS (characteristic)
 - Connection type: AC coupled, single ended
 - AC input voltage range: 1 V pp (max)
 - Electrical return loss: -12 dB
- Optical input
 - Bandwidth: 7.5 GHz (max, characteristic)
 - For the optical input, must choose four filter rates out of a range from 155 Mb/s to 10.3125 Gb/s
 - Optical wavelength: 750 – 1650 nm
 - Fiber input: 62/125 μ m
 - Max. non-destructive input (1310 nm): -3 dBm avg, $+7$ dBm peak
 - Average power monitor range (850 nm): -30 dBm to -2 dBm

Web Link

www.agilent.com/find/pxi



Agilent offers a broad selection of digital multimeters to meet your measurement needs

Bench/System DMMs

Bench/System DMMs meet your testing needs for R&D, design verification and manufacturing. These DMMs provide a combination of bench top and system features that deliver a versatile solution. In addition to easy to use front panel display and functions for bench use, they provide flexible system features such as LAN, GPIB, USB, and RS-232 interfaces and standard programming languages such as SCPI. In addition, many of these DMMs offer fast reading rates and internal storage, making them ideal for system use.

System DMM

Especially designed for manufacturing test, the L4411A is a 1 U high DMM with extensive measurement capabilities available through GPIB and LAN interfaces.

Basic Bench DMM

With basic capabilities and solid performance, the U3400 Series DMMs offer a low cost alternative for educational, electronics and communications applications.

Modular DMM

Especially designed to be used with your PC in a laboratory environment, the U2741A USB modular DMM provides bench instrument capabilities in an affordable, space saving form factor. It can be used stand-alone or mounted in a chassis with other Agilent modular instruments.

Handheld DMM and Clamp Meters

Agilent offers hand held DMMs, multifunction calibrator/meter, and clamp meters for installation and maintenance measurement needs. These handheld tools meet critical safety standards and provide many common DMM features in a small package.

Bench/System Digital Multimeters, Voltmeter

Model	Description	Resolution	Measurement speed	Basic measurements	Connectivity	Page
34405A	Low cost DMM	5½ digits	19 rdgs/sec	DCV, DCI, true RMS ACV & ACI, 2 wire Ω, frequency & period, continuity, diode test, temperature	USB 2.0	129
U3606A	DMM/power supply	5½ digits	37 rdgs/sec	DCV, DCI, true RMS ACV & ACI, 2 & 4 wire Ω, frequency & period, continuity, diode test; dual power supply output 30 V/1 A & 8 V/3 A	GPIB and USB	134
34401A	General purpose DMM	6½ digits	1,000 rdgs/sec	DCV, DCI, true RMS ACV & ACI, 2 & 4 wire Ω, frequency & period, continuity, diode test	GPIB and RS-232	130
34410A	General purpose DMM	6½ digits	10,000 rdgs/sec	DCV, DCI, true RMS ACV & ACI, 2 & 4 wire Ω, frequency & period, continuity, diode test, temperature	LAN, GPIB, USB 2.0	130
34411A	High performance DMM	6½ digits	50,000 rdgs/sec	DCV, DCI, true RMS ACV & ACI, 2 & 4 wire Ω, frequency & period, continuity, diode test, temperature	LAN, GPIB, USB 2.0	130
34420A	Nanovolt/ohm meter	7½ digits	250 rdgs/sec	DCV, DCI, 2 & 4 wire Ω, 2 channel scanning, temperature (w/SPRT, RTD)	GPIB and RS-232	132
3458A	Reference DMM	8½ digits	100,000 rdgs/sec	DCV, DCI, true RMS ACV & ACI, 2 & 4 wire Ω, frequency & period, temperature	GPIB	133

System and Modular Digital Multimeters

Model	Description	Resolution	Measurement speed	Basic measurements	Connectivity	Page
L4411A	High performance system DMM	6½ digits	50,000 rdgs/sec	DCV, DCI, true RMS ACV & ACI, 2 & 4 wire Ω, frequency & period, continuity, diode test, temperature	LAN, GPIB, USB 2.0	130
U2741A	USB modular DMM	5½ digits	100 rdgs/sec	DCV, DCI, true RMS ACV & ACI, 2 & 4 wire Ω, frequency, continuity, diode test, temperature	USB 2.0	136

Bench Digital Multimeters

Model	Description	Resolution	Measurement speed	Basic measurements	Connectivity	Page
U3401A	Low cost basic DMM	4½ digits	n/a	DCV, DCI, true RMS ACV & ACI, 2 & 4 wire Ω, frequency & period, continuity, diode test	none	129
U3402A	Low cost basic DMM	5½ digits	n/a	DCV, DCI, true RMS ACV & ACI, 2 & 4 wire Ω, frequency & period, continuity, diode test	none	129

Handheld Digital Multimeters and Clamp Meters

Model	Description	Resolution	Measurement speed	Basic measurements	Connectivity	Page
U1210 Series	Handheld clamp meter for high current measurements	3½ digits (4000 counts)	7 rdgs/sec	DCV, DCI, true RMS ACV & ACI, ACI + DCI, 2 wire Ω, frequency, continuity with beep, temperature, capacitance, diode test	none	136
U1240 Series	Installation and maintenance DMM	4 digits (10000 counts)	7 rdgs/sec	DCV, DCI, true RMS ACV & ACI, 2 wire Ω, frequency, continuity with beep, diode test, temperature, capacitance, switch counter	none	135
U1250 Series	High performance handheld DMM	4½ digits (50000 counts)	7 rdgs/sec	DCV, DCI, true RMS ACV & ACI, 2 wire Ω, frequency, continuity with beep, diode test, temperature, capacitance	IR-USB	135
U1270 Series	Ergonomic industrial handheld DMM	4½ digits (30000 counts)	7 rdgs/sec	DCV, DCI, ACV, ACI, 2 wire Ω, frequency, continuity with beep, diode test, temperature, capacitance, peak detect, low pass filter	IR-USB	135
U1401B	Multi-function handheld calibrator/meter	4½ digits (50000 counts)	3 rdgs/sec	DCV, DCI, true RMS ACV & ACI, 2 wire Ω, frequency, continuity, diode test, temperature, capacitance, pulse width, duty cycle	IR-USB	136

Specifications

	34405A	34401A	34410A	34411A, L4411A	34420A	3458A	U3606A	U2741A
Description	Low-cost general purpose	General purpose	General purpose, high performance	High speed, enhanced performance	Specialized for nano-volt and micro-ohm measurements	Best speed, greatest accuracy	DMM/DC power supply; two independent instruments in one	Compact, USB-based module
Number of digits	5½	6½	6½	6½	7½	8½	5½	5½
Readings/second	19	1,000	10,000 (5½ digits)	50,000 (4½ digits)	250	100,000 (4½ digits)	37	100
Measurement ranges	100 mV to 1000 V	up to 1000 volts	up to 1000 volts	up to 1000 volts	1 mV to 100 V	0.1 V to 1000 V DC	DMM: 100 mV to 1000 V DC power supply: Range S1: up to 30 V, 1 A Range S2: up to 8 V, 3 A	100 mV to 300 V
	100 mVrms to 750 Vrms	(750 Vrms AC)	(750 Vrms AC)	(750 Vrms AC)	—	10 mV to 1000 V AC	100 mVrms to 750 Vrms	100 mVrms to 250 Vrms
		Signals 3 Hz to 300 kHz	Signals 3 Hz to 300 kHz	Signals 3 Hz to 300 kHz	—	1 Hz to 10 MHz		
	100 Ω to 100 MΩ		100 Ω to 1 GΩ	100 Ω to 1 GΩ	1 Ω to 1 MΩ	10 Ω to 1 GΩ	100 Ω to 100 MΩ	100 Ω to 100 MΩ
	10 mA to 10 A		100 μA to 3 A	1 μA to 3 A	—	100 nA to 1 A	10 mA to 3 A	10 mA to 2 A
Accuracy	Up to 0.025%	0.0015% DC accuracy	DC accuracy, 0.003%	DC accuracy, 0.003%	DC accuracy, 0.003%	0.6 ppm DC Volts	Up to 0.025%	Up to 0.02%
		0.06% AC accuracy	AC accuracy, 0.06%	AC accuracy, 0.06%		100 ppm AC Volts		
Memory (internal, non-volatile)	N/A	512 readings	50,000 readings	1 million readings	1024 readings	10,240 16-bit readings Opt 001 65,536 readings	N/A	
Program language	SCPI, IEEE-488.1, IEEE-488.2	SCPI	SCPI	SCPI	SCPI, Keithley 181	Instrument commands	SCPI	
Connectivity	USB 2.0	GPIO and RS-232	LAN, USB and GPIO	LAN, USB and GPIO	GPIO and RS-232	GPIO	USB 2.0, GPIO	USB 2.0

Web Link

www.agilent.com/find/dmm

- Rich features and broad ranges in elegantly simple and affordable DMMs
- 120,000 counts resolution (50,000 counts for U3401A)
- Built-in math functions



34405A digital multimeter

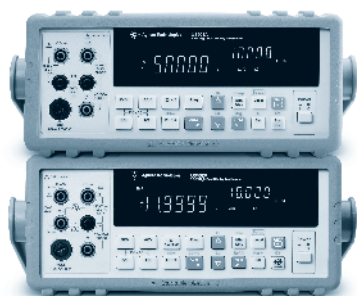

U3400 Series digital multimeters

34405A – Measure More in Less Time

16 Basic Measurements with Broad Ranges

- DC/AC voltage and current
- 2-wire ohms
- Frequency
- Capacitance
- Temperature
- Continuity and diode tests

High Accuracy

- 120,000 counts resolution
- 0.025% basic DCV accuracy

Built-In Math Functions

Do away with manual computation while you focus on measurements. Functions include dBm/dB, null, min/max, average and hold.

Plug-and-Play with USB

USB 2.0 makes the 34405A hot-swappable and auto-detectable, so you can save set-up time. The 34405A provides a fast measurement speed of 19 readings/s.

U3400 Series 4½ and 5½-digit DMMs

11 Basic Measurements

- DC, AC and AC + DC voltage and current measurements
- 2-wire, 4-wire ohms
- Frequency
- Continuity and diode tests

Excellent Accuracy

- Up to 0.012% DCV
- Up to 120,000 counts resolution
- Selectable resolutions for variable measurement speeds

Built-In Math Functions

Functions include dBm, relative, min/max, compare and hold

Security

Kensington lock slot helps secure your U3400 Series and prevents theft and misplacement.

Specifications

	U3401A	U3402A	34405A
Display	Dual	Dual	Dual
Resolution	50,000 counts	Selectable 120,000 40,000 or 4000 counts	120,000 counts
DC voltage	Accuracy: 0.02% Range: 500 mV – 1000 V	Accuracy: 0.012% Range: 120 mV – 1000 V	Accuracy: 0.025% Range: 100 mV – 1000 V
True RMS AC voltage	Accuracy: 0.35% Range: 500 mV – 750 V	Accuracy: 0.2% Range: 120 mV – 750 V	Accuracy: 0.2% Range: 100 mV – 750 V
True RMS AC+DC voltage	Accuracy: 0.5% Range: 500 mV – 750 V	Accuracy: 0.2% Range: 120 mV – 750 V	—
DC current	Accuracy: 0.05% Range: 500 µA – 10 A	Accuracy: 0.05% Range: 12 mA – 12 A	Accuracy: 0.05% Range: 10 mA – 10 A
True RMS AC current	Accuracy: 0.5% Range: 500 µA – 10 A	Accuracy: 0.5% Range: 12 mA – 12 A	Accuracy: 0.5% Range: 10 mA – 10 A
True RMS AC+DC current	Accuracy: 0.5% Range: 500 µA – 10 A	Accuracy: 0.5% Range: 12 mA – 12 A	—
Resistance	2-wire accuracy: 0.1% Range: 500 Ω – 50 MΩ	Selectable 2- or 4- wire accuracy: 0.05% (for 4-wire) Range: 120 Ω – 120 MΩ	Accuracy: 0.05% Range: 100 Ω – 100 MΩ
Frequency	Accuracy: 0.01% Range: 500 Hz – 500 kHz	Accuracy: 0.005% Range: 1200 Hz – 1 MHz	Accuracy: 0.02% Range: 1 Hz – 300 kHz
Diode, continuity	Yes	Yes	Yes
Math functions	dBm, relative, min/max, compare, hold, percentage	dBm, relative, min/max, compare, hold	dBm/dB, null, min/max, average, hold

Ordering Information

U3401A 4.5-digit dual display digital multimeter

U3402A 5.5-digit dual display digital multimeter

34405A 5.5-digit dual display digital multimeter

Web Link

www.agilent.com/find/low-cost-dmm

www.agilent.com/find/34405A

34410A
34411A
L4411A
34401A

- 6½ digit resolution
- 10,000 readings/second @ 5½ digits to the PC
- LAN, USB and GPIB standard
- Capacitance and temperature measurements
- Data logger for improved usability
- 50,000 reading non-volatile memory
- LXI Class C compliant

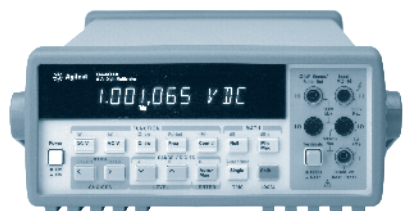

Well known 34401A

- 6½-digit resolution
- Measure up to 1000 DC volts (750 Vrms AC)
- Measure signals 3 Hz to 300 kHz
- 0.0015% DC accuracy
- 0.06% AC accuracy
- GPIB and RS-232 interfaces
- SCPI programming
- 1,000 readings per second
- Store up to 512 readings



High performance 34410A

Same as 34401A plus

- Improved accuracy
- Extended measurement ranges
- Capacitance measurements
- Temperature measurements
- Data logging up to 50K readings
- GPIB, LAN and USB interfaces
- Compensated ohms function
- 10,000 readings/sec at 6 ½ digits
- 1,000 readings/sec at 6 ¼ digits



Enhanced performance 34411A & L4411A

Same as 34410A plus

- 50,000 readings/sec at 4 ½ digits
- 1 million reading volatile memory
- Analog level triggering
- Programmable pre/post triggering

L4411A:

34411A in a 1 U high package
Optimal for manufacturing systems

34410A Digital Multimeter

The Agilent 34410A is a high performance digital multimeter designed for high speed and precise triggering, offering maximum versatility for present and future needs. The 34410A offers improved accuracy, expanded measurement capability with dramatically improved measurement speed and throughput. The 34410A is a 6½ digit, dual display, benchtop and system digital multimeter featuring 10,000 readings per second at 5½ digits, datalogging, resistance and frequency, and LAN, USB and GPIB connectivity. If you need up to 50,000 readings/second, consider the 34411A 6½ digit enhanced performance digital multimeter.

Spectacular Speed

Whether it's raw reading speed or fast system throughput, the 34410A sets a new benchmark in price performance. Using a new A/D technology, the 34410A can stream readings to your computer at an impressive 10,000 readings a second at 5½-digits! Triggering is fast and precise, with both trigger latency and trigger jitter less than 1 µs, while bus query response is less than 500 µs. ACV measurements are faster as well thanks to a digital measurement technique that additionally improves accuracy at high and low frequencies. For even greater reading speeds, select the 34411A, which achieves 50,000 readings a second at 4½-digits.

Enhanced Measurement Performance

The 34410A and 34411A offer temperature and capacitance capabilities, in addition to those measurements you have come to expect, such as DCV, ACV, DCI, ACI, 2-wire and 4-wire resistance, frequency, period, continuity, and diode test. You also get offset compensated ohms, allowing you to accurately measure resistance in the presence of voltages. The expanded measurement ranges allow DC and AC current ranges to go down to 100 µA, resulting in 100 pA resolution. Real-time math and statistics are included, and a peak-detect capability allows you to capture peaks as short as 20 µs.

34401A Digital Multimeter

The Agilent Technologies 34401A multimeter gives you the performance you need for fast, accurate bench and system testing. The 34401A provides a combination of resolution, accuracy and speed that rivals DMMs costing many times more. 6½ digits of resolution, 0.0015% basic 24-hr dcV accuracy and 1,000 readings/s assure you of results that are accurate, fast, and repeatable.

Functions commonly associated with bench operation, like continuity, diode test, min/max/avg readouts and direct dB and dBm measurements are built in. A Null feature allows you to remove lead resistance and other fixed offsets in your measurements.

The 34401A gives you the ability to store up to 512 readings in internal memory. Trouble-shooting is easier with a reading hold feature lets you concentrate on placing your test leads without having to constantly glance at the display. For systems use, the 34401A gives you fast bus throughput and can send up to 1,000 readings/s directly across GPIB in user-friendly ASCII format.

Abbreviated Technical Specifications

Accuracy specifications ± (% of reading + % of range)¹

Function	Range ²	Frequency, test current, or burden voltage	24 hour Tcal ±1 °C	90 day Tcal ±5 °C	1 year Tcal ±5 °C	Temperature coefficient/°C 0 °C to (Tcal -5 °C) (Tcal +5 °C) to 55 °C
DC voltage	100.0000 mV		0.0030 + 0.0030	0.0040 + 0.0035	0.0050 + 0.0035	0.0005 + 0.0005
	1.000000 V		0.0020 + 0.0006	0.0030 + 0.0007	0.0035 + 0.0007	0.0005 + 0.0001
	10.000000 V		0.0015 + 0.0004	0.0020 + 0.0005	0.0030 + 0.0005	0.0005 + 0.0001
	100.00000 V		0.0020 + 0.0006	0.0035 + 0.0006	0.0040 + 0.0006	0.0005 + 0.0001
	1000.0000 V		0.0020 + 0.0000	0.0035 + 0.0006	0.0040 + 0.0006	0.0005 + 0.0001
True RMS AC voltage³	100.0000 mV to 750.0000 V	3 – 5 Hz	0.50 + 0.02	0.50 + 0.03	0.50 + 0.03	0.010 + 0.003
		5 – 10 Hz	0.10 + 0.02	0.10 + 0.03	0.10 + 0.03	0.008 + 0.003
		10 Hz – 20 kHz	0.02 + 0.02	0.05 + 0.03	0.06 + 0.03	0.005 + 0.003
		20 – 50 kHz	0.05 + 0.04	0.09 + 0.05	0.10 + 0.05	0.010 + 0.005
		50 – 100 kHz	0.20 + 0.08	0.30 + 0.08	0.40 + 0.08	0.020 + 0.008
		100 – 300 kHz	1.00 + 0.50	1.20 + 0.50	1.20 + 0.50	0.120 + 0.020
Resistance⁴	100.0000 Ω	1 mA	0.0030 + 0.0030	0.008 + 0.004	0.010 + 0.004	0.0006 + 0.0005
	1.000000 kΩ	1 mA	0.0020 + 0.0005	0.007 + 0.001	0.010 + 0.001	0.0006 + 0.0001
	10.000000 kΩ	100 μA	0.0020 + 0.0005	0.007 + 0.001	0.010 + 0.001	0.0006 + 0.0001
	100.00000 kΩ	10 μA	0.0020 + 0.0005	0.007 + 0.001	0.010 + 0.001	0.0006 + 0.0001
	1.000000 MΩ	5 μA	0.0020 + 0.0010	0.010 + 0.001	0.012 + 0.001	0.0010 + 0.0002
	10.000000 MΩ	500 nA	0.0100 + 0.0010	0.030 + 0.001	0.040 + 0.001	0.0030 + 0.0004
	100.00000 MΩ	500 nA 10 MΩ	0.200 + 0.001	0.600 + 0.001	0.800 + 0.001	0.1000 + 0.0001
	1.000000 GΩ	500 nA 10 MΩ	2.000 + 0.001	6.000 + 0.001	8.000 + 0.001	1.0000 + 0.0001
DC current	100.00000 μA	< 0.03 V	0.010 + 0.020	0.040 + 0.025	0.050 + 0.025	0.0020 + 0.0030
	1.0000000 mA	< 0.3 V	0.007 + 0.006	0.030 + 0.006	0.050 + 0.006	0.0020 + 0.0005
	10.0000000 mA	< 0.03 V	0.007 + 0.020	0.030 + 0.020	0.050 + 0.020	0.0020 + 0.0020
	100.000000 mA	< 0.3 V	0.010 + 0.004	0.030 + 0.005	0.050 + 0.005	0.0020 + 0.0005
	1.0000000 A	< 0.8 V	0.050 + 0.006	0.080 + 0.010	0.100 + 0.010	0.0050 + 0.0010
	3.0000000 A	< 2.0 V	0.100 + 0.020	0.120 + 0.020	0.150 + 0.020	0.0050 + 0.0020
	True RMS AC current⁵	100.0000 μA to 3.000000 A	3 Hz – 5 kHz	0.10 + 0.04	0.10 + 0.04	0.10 + 0.04
5 – 10 kHz			0.20 + 0.04	0.20 + 0.04	0.20 + 0.04	0.030 + 0.006
Frequency or period	100 mV to 750 V	3 – 5 Hz	0.070 + 0.000	0.070 + 0.000	0.070 + 0.000	0.005 + 0.000
		5 – 10 Hz	0.040 + 0.000	0.040 + 0.000	0.040 + 0.000	0.005 + 0.000
		10 – 40 Hz	0.020 + 0.000	0.020 + 0.000	0.020 + 0.000	0.001 + 0.000
		40 Hz – 300 kHz	0.005 + 0.000	0.006 + 0.000	0.007 + 0.000	0.001 + 0.000
Capacitance⁶	1.0000 nF	500 nA	0.50 + 0.50	0.50 + 0.50	0.50 + 0.50	0.05 + 0.05
	10.000 nF	1 μA	0.40 + 0.10	0.40 + 0.10	0.40 + 0.10	0.05 + 0.01
	100.00 nF	10 μA	0.40 + 0.10	0.40 + 0.10	0.40 + 0.10	0.01 + 0.01
	1.0000 μF	10 μA	0.40 + 0.10	0.40 + 0.10	0.40 + 0.10	0.01 + 0.01
	10.000 μF	100 μA	0.40 + 0.10	0.40 + 0.10	0.40 + 0.10	0.01 + 0.01
Temperature⁷ RTD thermistor	-200 to 600 °C	—	0.06 °C	0.06 °C	0.06 °C	0.003 °C
	-80 to 150 °C	—	0.08 °C	0.08 °C	0.08 °C	0.002 °C
Continuity	1000.0 Ω	1 mA	0.002 + 0.010	0.008 + 0.020	0.010 + 0.020	0.0010 + 0.0020
Diode test⁸	1.0000 V	1 mA	0.002 + 0.010	0.008 + 0.020	0.010 + 0.020	0.0010 + 0.0020

¹ Specifications are for 90 minute warm-up and 100 PLC

² 20% overrange on all ranges, except DCV 1000 V, ACV 750 V, DCI, and ACI 3 A ranges

³ Specifications are for sinewave input > 0.3% of range and > 1 mVrms. Add 30 uV error for frequencies below 1 kHz. 750 VAC range limited to 8 x 107 Volts-Hz. For each additional volt over 300 Vrms add 0.7 mVrms of error

⁴ Specifications are for 4-wire resistance measurements, or 2-wire using math null. Without math null, add 0.2 Ω additional error in 2-wire resistance measurements

⁵ Specifications are for sinewave input > 1% of range and > 10 μArms. Frequencies > 5 kHz are typical for 1 A and 3 A ranges

⁶ Specifications are for 1-hour warm-up using math null. Additional errors may occur for non-film capacitors

⁷ For total measurement accuracy, add temperature probe error

⁸ Accuracy specifications are for the voltage measured at the input terminals only. 1 mA test current is typical. Variation in the current source will create some variation in the voltage drop across a diode junction

Ordering Information

34410A 6½ digit DMM

Comes with programming examples and drivers on a CD

Agilent Accessories

11059A Kelvin probe set

11060A surface mount device (SMD) test probes

11062A Kelvin clip set

34171A/B input terminal connector (sold in pairs)

34172A/B input calibration short (sold in pairs)

34330A 30 A current shunt

E2308A 5 k thermistor probe

Web Link

www.agilent.com/find/34410A

34420A

- 7½ digit resolution
- High sensitivity DCV and resistance measurements at 100 pV and 100 nΩ
- Built-in low noise 2 channel scanners
- 1.3 nVrms, 8 nVpp noise performance
- Temperature measurements with 0.003 deg C accuracy using SPRT probes



34420A

34420A Nanovolt/Micro-ohm Meter

The Agilent 34420A nanoVolt/micro-Ohm meter is a high-sensitivity multimeter optimized for performing low-level measurements. It combines low-noise voltage measurements with resistance and temperature functions, setting a new standard in low-level flexibility and performance.

Accurate, Repeatable Low-Level Measurements

Low-noise input amplifiers and a highly tuned input protection scheme bring reading noise down to 8 nVpp. Combine this with 7½ digits of resolution, selectable analog and digital filtering, 2 ppm basic 24-hour dcV accuracy, and a shielded, copper pin connector and you've got accurate, repeatable measurements you can count on.

Unprecedented Functionality

Two input channels allow voltage measurements to be made independently, or they can be mathematically combined to make difference and ratio measurements. Ohms measurements combine the low-noise input circuits with a highly-stable current source to provide outstanding low-resistance measurements. Offset compensation is employed to eliminate the effects of stray thermal EMFs that would otherwise result in measurement error. Low power ohms and low-voltage resistance measurement capability allow repeatable measurements to be made where a low voltage (20 mV) is required to avoid oxidation punch-through. A wide range of temperature measurement capabilities are also built in, providing support for SPRT, thermocouple, RTD, and thermistor temperature sensors.

Abbreviated Technical Specifications

Accuracy specifications ±(% of reading + % of range)¹

Function	Range ²	Test current	24 hour 23 ± 1 °C	90 day 23 ± 5 °C	1 year 23 ± 5 °C
DC voltage	1 mV ³		0.0025 + .0020	0.0040 + .0020	0.0050 + .0020
	10 mV ³		0.0025 + .0002	0.0040 + .0002	0.0050 + .0003
	100 mV		0.0015 + .0003	0.0030 + .0004	0.0040 + .0004
	1 V		0.0010 + .0003	0.0025 + .0004	0.0035 + .0004
	10 V		0.0002 + .0001	0.0020 + .0004	0.0030 + .0004
	100 V ⁴		0.0010 + .0004	0.0025 + .0005	0.0035 + .0005
Resistance⁵	1 Ω	10 mA	0.0015 + .0002	0.0050 + .0002	0.0070 + .0002
	10 Ω	10 mA	0.0015 + .0002	0.0040 + .0002	0.0060 + .0002
	100 Ω	10 mA	0.0015 + .0002	0.0040 + .0002	0.0060 + .0002
	1 KΩ	1 mA	0.0015 + .0002	0.0040 + .0002	0.0060 + .0002
	10 KΩ	100 μA	0.0015 + .0002	0.0040 + .0002	0.0060 + .0002
	100 KΩ	10 μA	0.0015 + .0003	0.0040 + .0004	0.0060 + .0004
	1 MΩ	5 μA	0.0020 + .0003	0.0050 + .0004	0.0070 + .0004
Low power resistance⁵	1 Ω	10 mA	0.0015 + .0002	0.0050 + .0002	0.0070 + .0002
	10 Ω	10 mA	0.0015 + .0002	0.0040 + .0002	0.0060 + .0002
	100 Ω	1 mA	0.0015 + .0002	0.0040 + .0002	0.0060 + .0002
	1 KΩ	100 μA	0.0015 + .0002	0.0040 + .0002	0.0060 + .0002
	10 KΩ	10 μA	0.0015 + .0004	0.0040 + .0004	0.0060 + .0004
	100 KΩ	5 μA	0.0015 + .0012	0.0040 + .0015	0.0060 + .0015
	1 MΩ	5 μA	0.0020 + .0003	0.0050 + .0004	0.0070 + .0004
Voltage limited resistance^{5,6}	10 Ω	1 mA	0.0020 + .0002	0.0050 + .0002	0.0070 + .0002
	100 Ω	100 μA	0.0025 + .0002	0.0050 + .0002	0.0070 + .0002

¹ Specifications are for Channel 1 or Channel 2, after 2-hour warm-up, resolution at 7.5 digits (100 NPLC), with FILTERS off. RESISTANCE specifications are for 4-wire Ohms or 2-wire ohms using Null. Without Null, add 0.2 Ohms additional error in 2-wire Ohms function. For Analog Filter ON, add 0.002% of reading

² 20% overrange on all ranges except 5% on voltage limited resistance

³ After using Math Null. If Null is not used add 100 nanoVolts

⁴ Channel 1 only

⁵ Channel 1 only. Resistance measurements, for NPLC < 1, add 160 μΩ rms noise

⁶ Voltage limit can be set to 20 mV (default), 100 mV, or 500 mV. Measured resistance plus Channel 1 HI and LO lead resistance is limited to 10.5 Ω on the 10 Ω range and 105 Ω on the 100 Ω range

Ordering Information

34420A nanoVolt/micro-Ohm meter includes low-thermal input cable (34102A), low-thermal shorting plug (34103A), Kelvin clip set (11062A), operating manual, service manual, quick reference guide, test report with calibration sticker, contact cleaner, and power cord

Accessories

- 34102A** low-thermal input cable (four conductor) with copper spade lugs
- 34103A** low-thermal shorting plug
- 34104A** low-thermal input connector
- 34161A** accessory pouch

Web Link

www.agilent.com/find/34420A

- DC Volts, 5 ranges: 0.1 to 1000 V
- AC Volts, 6 ranges: 10 mV to 1000 V
- Frequency: 1 Hz to 10 MHz
- Period: 100 ns to 1 second
- 8-ppm 1 year dcV accuracy, optional 4-ppm
- 0.05 ppm dcV transfer accuracy
- 100,000 readings per second at 4½ digits



3458A

3458A 8½ Digit Multimeter

The Agilent 3458A multimeter shatters long-standing performance barriers of speed and accuracy on the production test floor, in research and development, and in the calibration lab. The 3458A is the fastest, most flexible, and most accurate multimeter offered by Agilent Technologies. In your system or on the bench, the 3458A saves you time and money with unprecedented test-system throughput and accuracy, seven-function measurement flexibility, and low cost of ownership. Select a rate of 100,000 reading per second for maximal test throughput. Or achieve highest levels of precision with up to 8½ digits of measurement resolution and 0.1 part per million transfer accuracy. Add to this the 3458A's simplicity of operation, and you have the ideal multimeter for your most demanding applications.

Product Precision

Consider the 3458A's 0.6 ppm 24 hour DC Volts accuracy, 100 ppm AC Volts accuracy and its standard functions of DCV, DCI, True RMS ACV and ACI, Ohms, frequency and period. Greater measurement accuracy from your dmm means higher confidence and higher test yields. More functions mean greater versatility and lower-cost test systems. The 3458A is simply the fastest, most flexible, and most accurate multimeter ever offered by Agilent Technologies.

Abbreviated Technical Specifications

DC voltage

Range	Full scale	Maximum resolution	Input impedance	1-year* accuracy ppm of rdg + ppm of range
100 mV	120.00000	10 nV	> 10 GΩ	9 (5) + 3
1 V	1.2000000	10 nV	> 10 GΩ	8 (4) + 0.3
10 V	12.0000000	100 nV	> 10 GΩ	8 (4) + 0.05
100 V	120.000000	1 μV	10 MΩ ± 1%	10 (6) + 0.3
1000 V	1050.00000	10 μV	10 MΩ ± 1%	10 (6) + 0.1

One-year specification for NPLC 100 within 24 hours and ±1 °C of last ACAL, Tcal ±5 °C, MATH NULL, fixed range. Add 2 ppm of reading additional error for Agilent factory traceability of 10 V DC to US NIST. Traceability error is the absolute error relative to National Standard 48r associated with the source of last external calibration. Full scale to 10% of full scale. Measurements on the 1000 V range are within 5% of the initial measurement value and following measurement settling. Tref is the starting ambient temperature. Measurements are made on a fixed range using accepted metrology practices.

* High stability (Option 002), ppm of reading are shown in parentheses

Noise rejection (dB)*

	AC NMR **	AC ECRM	DC ECRM
NPLC < 1	0	90	140
NPLC 1 to 100	60	150	140
NPLC = 1000	75	170	140

* Applies for 1 kΩ unbalanced in the LO lead and ± 0.1% of the line frequency currently set for LFREQ

** For line frequency ± 1%, ACNMR is 40 dB for NPLC ≥ 1, or 55 dB for NPLC ≥ 100. For line frequency ± 5%, ACNMR is 30 dB for NPLC ≥ 100

True rms AC voltage (synchronous subsampled mode)

Range	Full scale	Maximum resolution	Input impedance	Temperature coefficient* (% of reading % + of range)/°C
10 mV	12.00000	10 nV	1 MΩ**	0.002 + 0.02
100 mV	120.0000	10 nV	1 MΩ**	0.001 + 0.0001
1 V	1.200000	100 nV	1 MΩ**	0.001 + 0.0001
10 V	12.00000	1 μV	1 MΩ***	0.001 + 0.0001
100 V	120.0000	10 μV	1 MΩ***	0.001 + 0.0001
1000 V	700.0000	100 μV	1 MΩ***	0.001 + 0.0001

* Additional error beyond ± 1 °C, but within +5 °C of last ACAL

** ± 15% with < 140 pF

*** ± 2% with < 140 pF

Maximum input (DC Volt and true rms AC Volt)

	Rated input	Nondestructive
HI to LO	± 1000 V pk	± 1200 V pk
LO to guard	± 200 V pk	± 350 V pk
Guard to earth	± 500 V pk	± 1000 V pk
HI or LO to earth	± 1000 V pk	± 1200 V pk

Resistance

Range	Full scale	Maximum resolution	Current source	1-year accuracy* 4-wire Ω ppm of rdg + ppm of range
10 Ω	12.00000	10 μΩ	10 mA	15 + 5
100 Ω	120.0000	10 μΩ	1 mA	12 + 5
1 kΩ	1.200000	100 μΩ	1 mA	10 + 0.5
10 kΩ	12.00000	1 mΩ	100 μA	10 + 0.5
100 kΩ	120.0000	10 mΩ	50 μA	10 + 0.5
1 MΩ	1.200000	100 mΩ	5 μA	15 + 2
10 MΩ	12.00000	1 Ω	500 nA	50 + 10
100 MΩ	120.0000	10 Ω	500 nA	500 + 10
1 GΩ	1.200000	100 Ω	500 nA	0.5% + 10

* Specifications for 100 NPLC, offset compensation on, within 24 hours and ±1 °C of last ACAL, Tcal ±5 °C. Add 3 ppm of reading additional error for Agilent factory traceability of 10 kΩ to US NIST

Memory

	Standard		Option 001	
	Readings	Bytes	Readings	Bytes
Reading storage (16 bit)	10,240	20 K	+65,536	+128 k
Non-volatile, for subprograms and/or state storage	–	14 k	–	–

Math functions

The 3458A performs the following math function on measurements: null, scale, offset, rms filter, single pose filter, thermistor linearization db, dbm % error, pass/fail limit testing, and statistics.

Ordering Information

Agilent 3458A multimeter

3458A-001 extended reading memory (expands total to 148 k bytes)

3458A-002 high stability (4 ppm/year) reference

Accessories

11053A low thermal test lead pair, spade lug to spade lug, 0.9 m

11174A low thermal test lead pair, spade lug to banana, 0.9 m

11058A low thermal test lead pair, banana to banana, 0.9 m

11059A Kelvin probe set (4-wires, 1 m)

11062A Kelvin clip set (2 each)

Web Link

www.agilent.com/find/3458A

U3606A

Full-featured DMM

- 9 measurement functions, including capacitance
- 8 built-in math functions
- 4-wire milliohm measurement with 0.001 mΩ resolution

Full-featured DC Power Supply

- 30 W, dual-range 30 V/1 A and 8 V/3 A
- Ability to source constant-voltage and –current directly
- OVP and OCP load protection
- Auto ramp and scan for multi-level DC bias testing



U3606A digital multimeter/DC power supply

DMM and power supply? Simultaneous and independent? Get all this and more in the Agilent U3606A multimeter/DC power supply. This convenient new hybrid combines a 5½-digit DMM and 30-W dual-range supply in a single unit. The two full-featured instruments work independently, providing a space-efficient solution. Small and cost-effective? Supply and measure? Pick any two with the Agilent U3606A.

The 5½-digit DMM

The 5½-digit DMM includes nine essential multimeter capabilities as well as 4-wire milliohm measurement and eight built-in math functions. The DMM also provides fast measurement speed of up to 37 readings/s and a low error rate of up to 0.025% DCV accuracy.

The 30-W DC Power Supply

The power supply provides a dual-range output of 30 V/1 A and 8 V/3 A, with an excellent load regulation of up to 0.01% + 3 mV. The power supply adds overvoltage and overcurrent load protection (OVP and OCP), a built-in square-wave generator, and auto scan and ramp for multi-level DC bias testing. Remote sensing capability further ensures accurate supply of power at load end.

Specifications

DMM functions

- Resolution: 120,000 counts
- DC voltage:
 - Accuracy: 0.025%
 - Range: 100 mV – 1000 V
- True RMS AC voltage:
 - Accuracy: 0.2%
 - Range: 100 mV – 750 V
- DC current:
 - Accuracy: 0.05%
 - Range: 10 mA – 3 A
- True RMS AC current:
 - Accuracy: 0.5%
 - Range: 100 mA – 3 A
- Resistance:
 - 2-wire
 - Accuracy: 0.05%
 - Range: 100 Ω – 100 MΩ
 - 4-wire
 - Accuracy: 0.25%
 - Range: 100 mΩ – 10 Ω
- Frequency:
 - Accuracy: 0.02%
 - Range: 1 Hz – 300 kHz
- Capacitance:
 - Accuracy: 1%
 - Range: 1 nF – 10,000 μF
- Diode, continuity: Yes
- Math functions: null, dB, dBm, min/max/avg, limit, hold
- Reading speed: up to 37 readings/s

Power supply functions

- Output ratings: 30 V/1 A, 8 V/3 A
- Regulation:
 - Load
 - Voltage: 0.01% + 3 mV
 - Current: 0.03% + 0.3 mA
 - Line
 - Voltage: 3 mV
 - Current: 1.5 mA
- Ripple and noise:
 - Voltage: < 2 mVrms; < 30 mVpp
 - Current: < 1 mArms
- Transient response: 300 ms
- Front panel resolution:
 - Voltage: 1 mV
 - Current: 0.1 mA
- Programming:
 - Accuracy
 - Voltage: 0.05% + 5 mV
 - Current: 0.15% + 3 mA
 - Resolution
 - Voltage: 1 mV
 - Current: 0.1 mA
- Readback:
 - Accuracy
 - Voltage: 0.05% + 5 mV
 - Current: 0.15% + 3 mA
 - Resolution
 - Voltage: 1 mV
 - Current: 0.1 mA

General

- Security: Kensington lock slot
- Connectivity: USB 2.0 (TMC-488.2), GPIB

Ordering Information

U3606A multimeter/DC power supply

Web Link

www.agilent.com/find/hybrid-multimeter

U1240 Series

- Low micro-amp and high mega-ohm ranges
- Switch/relay counter for glitch detection
- Dual and differential temperature measurements

U1250 Series

- High contrast ratio of 2000:1 and wide viewing angle of 160°
- Built-in square-wave generator and frequency counter

U1270 Series

- Dust and water resistant, IP 54 certified
- Low pass filter, low impedance mode features

Agilent Handheld DMMs provide CAT III 1000 V and CAT IV 600 V safety protections



U1240 Series handheld digital multimeters



U1250 Series handheld digital multimeters



U1270 Series handheld digital multimeters

U1240 Series Digital Multimeters

Installation and maintenance of machinery, electrical systems and more often require numerous quick checks and fixes, sometimes under hazardous conditions. Whether you need to quickly inspect power supplies for harmonics, detect glitches in switch systems or monitor differential temperature, the U1240 Series is up to the task.

U1250 Series Digital Multimeters

The U1250 Series offers powerful features and performance that simplifies analysis, accelerates glitch detection and makes it easier to probe hard-to-reach points. This Series showcases the world's first OLED handheld DMM, the U1253B. On the go or on the bench, you'll get crystal-clear viewing indoors, even in dark, off-angle situations.

U1270 Series Digital Multimeters

Water and dust resistant. Grip-friendly and feature packed. That's what you get with an Agilent U1270 Series handheld DMM. These IP 54 certified multimeters provide smart features that improve productivity; such as low impedance mode to eliminate stray voltages, and Smart Ohm to minimize false readings from residual voltage due to leakage current. The U1270 Series is also equipped with Backlight Alert which flashes the backlight to provide visual indication and improve safety.

Ordering Information

- U1241B handheld digital multimeter
- U1242B handheld digital multimeter
- U1251B handheld digital multimeter
- U1252B handheld digital multimeter
- U1253B handheld digital multimeter
- U1271A handheld digital multimeter
- U1272A handheld digital multimeter

Specifications

	U1241B	U1242B	U1251B	U1252B	U1253B	U1271A	U1272A
Display resolution (counts)	10,000	10,000	50,000	50,000	50,000	30,000	30,000
Auto/manual ranging	Yes	Yes	Yes	Yes	Yes	Yes	Yes
AC bandwidth	2 kHz	2 kHz	30 kHz	100 kHz	100 kHz	20 kHz	100 kHz
True RMS	AC	AC	AC	AC+DC	AC+DC	AC	AC
Voltage AC/DC: range	1 to 1000 V	1 to 1000 V	50 mV to 1000 V	50 mV to 1000 V	50 mV to 1000 V	300 mV to 1000 V	30 mV to 1000 V
Current AC/DC: range	1 mA to 10 A	1 mA to 10 A	500 uA to 10 A	500 uA to 10 A	500 uA to 10 A	300 uA to 10 A	300 uA to 10 A
Resistance: range	1 kΩ to 100 MΩ	1 kΩ to 100 MΩ	500 Ω to 500 MΩ	500 Ω to 500 MΩ	500 Ω to 500 MΩ	300 Ω to 100 MΩ	30 Ω to 300 MΩ
Frequency: range	ACV: 20 Hz to 200 kHz; ACI: 20 Hz to 20 kHz	ACV: 20 Hz to 200 kHz; ACI: 20 Hz to 20 kHz	ACV: 20 Hz to 200 kHz; ACI: 20 Hz to 20 kHz	ACV: 20 Hz to 20 MHz; ACI: 20 Hz to 20 kHz	ACV: 20 Hz to 20 MHz; ACI: 20 Hz to 20 kHz	99.999 Hz to 999.99 kHz	99.999 Hz to 999.99 kHz
Capacitance: range	1 uF to 10 mF	1 uF to 10 mF	10 nF to 100 mF	10 nF to 100 mF	10 nF to 100 mF	10 nF to 10 mF	10 nF to 10 mF
Temperature: type, range	K: -40 to 1000 °C	K: -40 to 1000 °C J: -40 to 1000 °C	K: -200 to 1372 °C	K: -200 to 1372 °C J: -210 to 1200 °C	K: -200 to 1372 °C J: -210 to 1200 °C	K: -200 to 1372 °C	K: -200 to 1372 °C J: -200 to 1372 °C
Continuity with beeper	Yes	Yes	Yes	Yes	Yes	Yes	Yes
Diode test	Yes	Yes	Yes	Yes	Yes	Yes	Yes
Min/max recording	Yes	Yes	Yes	Yes	Yes	Yes	Yes
Display hold	Yes	Yes	Yes	Yes	Yes	Yes	Yes
Peak hold	—	—	Yes	Yes	Yes	Yes	Yes
Manual datalogging	—	Yes	Yes	Yes	Yes	Yes	Yes
PC connectivity	—	—	IR-USB	IR-USB	IR-USB	IR-USB	IR-USB
% scale of 4-20 mA	Yes	Yes	Yes	Yes	Yes	Yes	Yes
Battery	4x AAA	4x AAA	9 V	7.2 V (rechargeable)	7.2 V (rechargeable)	4x AAA	4x AAA

Web Link

www.agilent.com/find/handhelddmm

U1401B
U2741A
U1211A
U1212A
U1213A



U1401B handheld multi-function calibrator/meter



U1210 Series handheld clamp meters

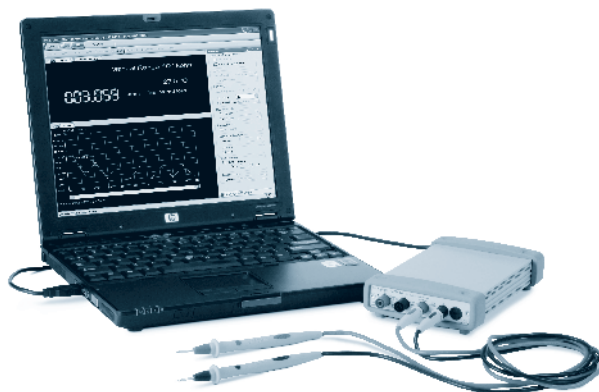

U2741A USB modular digital multimeter

U1401B Handheld Multi-Function Calibrator/Meter

- 50,000-count resolution on dual display
- Simultaneous source and measure capabilities
- Bipolar voltage and current, square-wave, auto scan and ramp outputs
- Full-span DMM measurement and recording functions

The two-in-one functionality of the U1401B handheld multi-function calibrator/meter lets you travel light when doing calibration for validation, troubleshooting, or service and maintenance.

U1210 Series Handheld Clamp Meters

- High measurement capability of up to 1000 A for AC, DC or AC+DC
- CAT III 1000 V/CAT IV 600 V safety rating
- Includes full-featured DMM with resistance, capacitance frequency and temperature functions

For cables up to two inches in diameter, the Agilent U1210 Series handheld clamp meters enable high-current measurements without breaking the circuit. They also include DMM capabilities to simplify troubleshooting during installation and maintenance.

Specifications

U1401B handheld multi-function calibrator/meter

Source

- Voltage and current: bipolar 15 V, 25 mA
- Square-wave: 0.5 Hz to 4.8 kHz, selectable Hz and %

Measure

- DC, AC, AC+DC: 250 V, 500 mA
- Resistance: 500 Ω to 50 M Ω
- Temperature: K-type TC -40 to 1372 $^{\circ}$ C (-40 to 2502 $^{\circ}$ F)
- Diode/Continuity
- 4-20 mA, 0 to 20 mA % scale
- Data hold
- Peak recording

Others

- Display: dual, segmented LCD
- Power: Ni-MH rechargeable batteries
- Safety: CAT II 150 V

U1210 Series handheld clamp meters

DC/AC voltage

- Accuracy: up to 0.2%
- Range: 0.1 – 1000 V

DC/AC current

- Accuracy: up to 1.0%
- Range: 0.01 – 1000 A

Ordering Information

U1401B handheld multi-function calibrator/meter

U1211A handheld digital clamp meter

U1212A handheld digital clamp meter

U1213A handheld digital clamp meter

Web Link

www.agilent.com/find/handheld-calibrator-meter
www.agilent.com/find/clampmeter

U2741A USB Modular Digital Multimeter

- Up to 100 readings per second
- Up to 300 VDC with 5 $\frac{1}{2}$ -digit resolution
- Frequency and temperature measurement capability
- Wide measurement ranges: 100 mVDC to 300 VDC, 10 mA to 2 A
- Compatibility with Hi-Speed USB 2.0, USBTMC-USB488 standard
- Bundled software – Agilent Measurement Manager (AMM)

The Agilent U2741A DMM is a portable, accurate and reliable USB-based modular instrument. It offers a wide range of measurement functions and features despite its compact size and value price. The U2741A provides quick and easy connectivity to your PC via USB 2.0 interface and data logging capability with the bundled AMM software without any programming involved. It is also compatible with a wide range of Agilent development environments (ADEs).

Specifications

- DC voltage:
 - Accuracy: 0.015%
 - Range: 100 mV – 300 V
- AC voltage:
 - Accuracy: 0.2%
 - Range: 100 mV – 250 V
- DC current:
 - Accuracy: 0.06%
 - Range: 10 mA – 2 A
- AC current:
 - Accuracy: 0.5%
 - Range: 10 mA – 2 A
- Resistance:
 - 2-wire
 - Accuracy: 0.03%
 - Range: 100 Ω – 100 M Ω
 - 4-wire
 - Accuracy: 0.03%
 - Range: 100 m Ω – 10 Ω
- Frequency:
 - Accuracy: 0.02%
 - Range: 20 Hz – 300 kHz
- Diode, continuity
- Reading speed: up to 100 readings/s

Ordering Information

U2741A USB modular digital multimeter

Web Link

www.agilent.com/find/U2741A

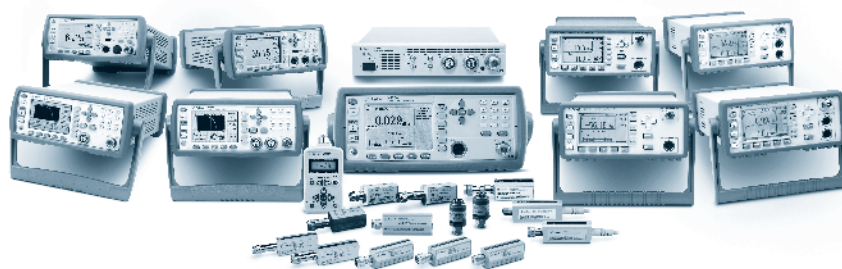

Agilent power meters and power sensors

For years, Agilent's broad range of reliable, high-performance power meters and sensors has been deployed all over the globe for various power measurement applications. Whatever you needs – compact ATE systems, effective capture and analysis of WiMAX and Bluetooth signals, or lightweight, plug-and-play easy base-station testing – Agilent has the right solution for you. Agilent's power meters have long been recognized as the industry standard for RF and microwave power measurements. Our power meters and sensors come in various form factors to cater for average power measurements as well as both average and peak measurements.

Power Meters and Sensors Compatibility Chart and Selection Guide

		Power meters				Product description / Sensor tech.	Frequency range	Power range	
		Average power measurement		Average and peak power measurement					
		N432A	N1913A/ N1914A	E4416A/ E4417A	N1911A/ N1912A/ N8262A				
Power sensors	P-Series wideband sensors	N1921A	—	—	—	Yes	Diode power sensor	50 MHz to 18 GHz	-35 dBm (316 nW) to +20 dBm (100 mW)
		N1922A	—	—	—	Yes	Diode power sensor	50 MHz to 40 GHz	-35 dBm (316 nW) to +20 dBm (100 mW)
	E-Series peak-and-average sensors	E932xA	—	—	Yes	Yes	Diode power sensor	50 MHz to 18 GHz	-65 dBm (320 pW) to +20 dBm (100 mW)
		E-Series true average power sensors	E930xA	—	Yes	Yes	Yes	Diode power sensor	9 kHz to 24 GHz ¹
	E930xB/H		—	Yes	Yes	Yes	Diode power sensor	10 MHz to 18 GHz	-50 dBm (10 nW) to +44 dBm (25 W)
	E-Series CW-only power sensors	E441xA	—	Yes	Yes	Yes	Diode power sensor	10 MHz to 33 GHz ¹	-70 dBm (100 pW) to +20 dBm (100 mW)
	N848x / 848x thermocouple and diode sensors	N848xA	—	Yes	Yes	Yes	Thermocouple power sensor	100 kHz to 67 GHz	-35 dBm (316 nW) to +20 dBm (100 mW)
		N848xB/H	—	Yes	Yes	Yes	High power thermocouple sensor	100 kHz to 18 GHz	-15 dBm (32 μW) to +44 dBm (25 W)
		848xD	—	Yes	Yes	Yes	Diode power sensor	10 MHz to 50 GHz	-70 dBm (100 pW) to -20 dBm (10 μW)
		8483A	—	Yes	Yes	Yes	Thermocouple power sensor	100 kHz to 2 GHz	-30 dBm (1 μW) to +20 dBm (100 mW)
	Waveguide sensors	R8486D	—	Yes	Yes	Yes	Diode waveguide power sensor	26.5 to 40 GHz	-70 dBm (100 pW) to -20 dBm (10 μW)
		Q8486D	—	Yes	Yes	Yes	Diode waveguide power sensor	33 to 50 GHz	-70 dBm (100 pW) to -20 dBm (10 μW)
		N8486AR	—	Yes	Yes	Yes	Thermocouple waveguide power sensor	26.5 to 40 GHz	-35 dBm (316 nW) to +20 dBm (100 mW)
		N8486AQ	—	Yes	Yes	Yes	Thermocouple waveguide power sensor	33 to 50 GHz	-35 dBm (316 nW) to +20 dBm (100 mW)
		V8486A	—	Yes	Yes	Yes	Diode V-band waveguide power sensor	50 to 75 GHz	-30 dBm (1 μW) to +20 dBm (100 mW)
		W8486A	—	Yes	Yes	Yes	Diode waveguide power sensor	75 to 110 GHz	-30 dBm (1 μW) to +20 dBm (100 mW)
	Thermistor mount sensors	478A	Yes	—	—	—	Coaxial thermistor mount	100 kHz to 10 GHz ¹	-30 dBm (1 μW) to +10 dBm (10 mW)
		8478B	Yes	—	—	—	Coaxial thermistor mount	10 MHz to 18 GHz	-30 dBm (1 μW) to +10 dBm (10 mW)
	USB sensors	U200xA	—	Yes	—	—	Diode power sensor	9 kHz to 24 GHz	-60 dBm (1 nW) to +20 dBm (100 mW)
		U200xB	—	Yes	—	—	Diode power sensor	10 MHz to 18 GHz	-30 dBm (1 μW) to +44 dBm (25 W)
U200xH		—	Yes	—	—	Diode power sensor	10 MHz to 24 GHz	-50 dBm (10 nW) to +30 dBm (1 W)	

¹ Range is valid with option

Web Link

www.agilent.com/find/powermeters

N8262A
N1911A
N1912A
E4416A
E4417A

- Peak and average power measurements
- Up to 100 MSa/s continuous sampling
- Power range of up to +44 dBm (sensor-dependent)
- Frequency range of up to 110 GHz (sensor-dependent)



N8262A P-Series, N1911A/N1912A P-Series and E4416A/E4417A EPM-P Series power meters

N8262A P-Series Modular Power Meter for Compact ATE Systems

The N8262A is a dual-channel, LXI Class C compliant power meter that's designed to support LAN-based ATE systems. With its slim, half-rack build, the N8262A enables a smaller test system and ensures easier deployment. The power meter comes with power meter GUI software that simplifies control and viewing of measurement results.

Features:

- Peak, average, peak-to-average ratio power measurements
- 1U half-rack size
- 100 MSa/s continuous sampling, single-shot 30 MHz VBW
- Wireless presets include WLAN, radar and MCPA
- CCDF statistical analysis

N1911A/N1912A P-Series Power Meters for Effective Capture of Wireless Signals

The P-Series power meters are LXI Class C compliant, designed for high performance measurement of wireless signals such as WiMAX and radar. Predefined settings in the P-Series power meters enable effective capture of unpredictable wireless signals, with their high burst rates and fast, time-varying power levels. Internal zeroing and calibration are available with P-Series sensors.

Features:

- Peak, average, peak-to-average ratio power measurements
- 100 MSa/s continuous sampling, single-shot 30 MHz VBW
- Time-gated and free-run measurement modes
- Wireless presets include WiMAX, HSDPA and DME

E4416A/E4417A EPM-P Series Power Meters for Testing of Complex Modulation Formats

The EPM-P Series power meters operate with the E9320 Series peak-and-average power sensors for testing various complex modulation formats in wireless communication systems, such as TDMA and CDMA. These power meters are able to perform the following pulse characteristics automatically: power (pulse top, pulse base, distal, mesial, proximal, overshoot and burst average), frequency and time (pulse repetition frequency, pulse repetition interval, pulse width, off-time, rise time and fall time) and statistical analysis.

Features:

- Peak, average, peak-to-average ratio power measurements
- 20 MSa/s continuous sampling, 5 MHz video bandwidth
- High throughput – up to 1000 corrected readings/s via GPIB
- Wireless presets include GSM, Bluetooth and W-CDMA

Compatible Power Sensors:

E441xA E-Series diode power sensors
E9300 E-Series diode power sensors
E9320 E-Series diode power sensors
N1921A/N1922A P-Series wideband diode sensors (for N1911A/N1912A/N8262A)
N8480 Series thermocouple power sensors
848xD Series diode power sensors
8480 Series waveguide sensors

Ordering Information

N8262A P-Series modular power meter
N1911A P-Series power meter
N1912A P-Series power meter
E4416A EPM-P Series power meters
E4417A EPM-P Series power meters
E441xA E-Series diode power sensors
E9300 E-Series diode power sensors
E9320 E-Series diode power sensors
N1921A/N1922A P-Series wideband diode sensors (for N1911A/N1912A/N8262A)
N8480 Series thermocouple power sensors
848xD Series diode power sensors
8480 Series waveguide sensors

Web Link

www.agilent.com/find/powermeters

- For average power measurements
- Color LCD display
- SCPI standard interface commands



Average power meters

N432A Thermistor Power Meter for Metrology and Calibration Laboratories

The N432A is a single-channel, average RF power meter that is ideal for high-accuracy measurement applications, particularly in metrology and calibration laboratory environments.

Features:

- High accuracy ($\leq 0.2\% \pm 0.5 \mu\text{W}$)
- Built-in 6.5-digit ADC eliminates the need for an external DMM
- Selectable bridge resistance (100/200/300/400 Ω)
- DC substitution measurement, traceable to the U.S. national institute of standards and technology (NIST)

N1913A/N1914A EPM Series Power Meters for Flexible Testing: On the Rack and On the Go

The EPM Series provides fast, repeatable and reliable results for both bench/rack and field applications.

Features:

- Up to four-channel power measurements
- Fast measurement speed of 400 readings/second
- Absolute accuracy: ± 0.02 dB logarithmic, $\pm 0.5\%$ linear
- Convenient field usage with operating case and battery option

Compatible Power Sensors

For N432A:

- 478A coaxial thermistor mount power sensor
- 8478B coaxial thermistor mount power sensor

For N1913A/N1914A:

- U2000 Series USB power sensors
- N8480 Series thermocouple power sensors
- E441xA E-Series diode power sensors
- E9300 E-Series diode power sensors
- 848xD Series diode power sensors
- 8480 Series waveguide sensors

Ordering Information

- N1913A** EPM Series power meters
- N1914A** EPM Series power meters
- N432A** thermistor power meter
- 478A** coaxial thermistor mount power sensor
- 8478B** coaxial thermistor mount power sensor
- U2000** Series USB power sensors
- N8480** Series thermocouple power sensors
- E441xA** E-Series diode power sensors
- E9300** E-Series diode power sensors
- 848xD** Series diode power sensors
- 8480** Series waveguide sensors

Web Link

www.agilent.com/find/powermeters

- Enhanced viewing on large PC display
- Intuitive GUI for easy navigation to functions
- Multiple flexible display formats
- List view of more than 20 channels, plus measurement math results
- Min/max measurements
- Convenient sharing of software license with USB dongle option (N1918A Option 200)
- Limit and alert settings¹

N1913A
N1914A
N432A
N1918A

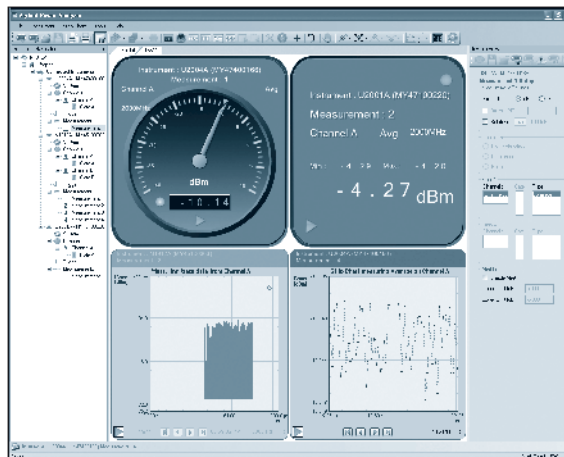

N1918A Power analysis manager

N1918A Power Analysis Manager

The N1918A power analysis manager software is a powerful application software that complements the U2000 Series USB power sensors and enhances capabilities of the N1911A/N1912A and N8262A P-Series power meters. There are two versions of the software: the basic power panel and advanced power analyzer.

Easy Monitoring and Analysis

Analyze power signals better with the software's wide range of functions, from the basic min/max and measurement math to the advanced CCDF² and pulse characterization².

Easy License Sharing Amongst Your Team

The USB dongle license (N1918 Option 200) enables the transfer of software license from one PC platform to another. This makes it easier for the sharing of license amongst multiple users in the team as they can conveniently run the power analyzer software on their respective PCs or laptops.

Ordering Information

- N1918A-100** N1918A power analyzer (with PC license)
- N1918A-200** N1918A power analyzer (with USB license key)

¹ Power analyzer version

² Applies to usage with P-Series power meters, power analyzer version

Web Link

www.agilent.com/find/N1918A

U2000 Series
V3500A

- Compact solutions for RF power measurements in installation and maintenance, production testing or R&D and design verification
- Wide dynamic and frequency range
- Simple set-up and usage
- High accuracy



U2000 Series USB power sensors



V3500A handheld RF power meter

U2000 Series USB Power Sensors for Mobile Testing That's Plug-and-Play Easy

Standalone USB-based U2000 Series power sensors enable power measurements without power meters. Each sensor draws minimal power from a USB port and is equipped with a built-in internal triggering module. Together with high accuracy and power as well as wide frequency and dynamic ranges, these sensors simplify portability and provide convenience, especially for base station testing.

Features:

- Average power measurements of CW and modulated signals including GSM, EDGE, WLAN and WiMAX
- 9 kHz to 24 GHz frequency range and -60 to +44 dBm dynamic range
- Built-in internal triggering and trace graph display
- Internal zeroing capability
- Feature-packed N1918A software provides various capabilities for easy testing and analysis

V3500A Handheld RF Power Meter for Portable RF Measurements

The V3500A is a portable, palm-sized power meter with an integrated power sensor and built-in display. Packed with essential average power measurement capabilities, the handheld power meter is a handy tool for installation and maintenance or R&D lab environments.

Features:

- Broad 10 MHz to 6 GHz frequency range enables mobile phones and infrastructures, WLAN devices, RFID readers, WiMAX devices and more
- Large dynamic range of -63 dBm to +20 dBm
- Integrated power sensor
- Internal power reference enables self-calibration

Specifications

U2000 Series USB power sensors

Frequency and power ranges

Model	Frequency range	Power range	Maximum power
U2000A	10 MHz to 18 GHz		+25 dBm avg, 20 VDC +33 dBm pk, < 10 μs
U2001A	10 MHz to 6 GHz	-60 to +20 dBm	
U2002A	50 MHz to 24 GHz		
U2004A	9 kHz to 6 GHz	-60 to +20 dBm	+25 dBm avg, 5 VDC +33 dBm pk, < 10 μs
U2000B	10 MHz to 18 GHz	-30 to +44 dBm	+45 dBm avg, 20 VDC +47 dBm pk, 1 μs
U2001B	10 MHz to 6 GHz		
U2000H	10 MHz to 18 GHz	-50 to +30 dBm	+33 dBm avg, 20 VDC +50 dBm pk, 1 μs
U2001H	10 MHz to 6 GHz		
U2002H	50 MHz to 24 GHz	-50 to +30 dBm	+33 dBm avg, 10 VDC +50 dBm pk, 1 μs

Maximum SWR

Model	Frequency range	Maximum SWR (25 °C ± 10 °C)	Maximum SWR (0 °C to 55 °C)
U2000A	10 to 30 MHz	1.15	1.21
	30 MHz to 2 GHz	1.13	1.15
	2 to 14 GHz	1.19	1.20
	14 to 16 GHz	1.22	1.23
	16 to 18 GHz	1.26	1.27
U2001A	10 to 30 MHz	1.15	1.21
	30 MHz to 2 GHz	1.13	1.15
	2 to 6 GHz	1.19	1.20
U2002A	50 MHz to 2 GHz	1.13	1.15
	2 to 14 GHz	1.19	1.20
	14 to 16 GHz	1.22	1.23
	16 to 18 GHz	1.26	1.27
	18 to 24 GHz	1.30	1.30
U2004A	9 kHz to 2 GHz	1.13	1.15
	2 to 6 GHz	1.19	1.20
U2000B	10 MHz to 2 GHz	1.12	1.14
	2 to 12.4 GHz	1.17	1.18
	12.4 to 18 GHz	1.24	1.25
U2001B	10 MHz to 2 GHz	1.12	1.14
	2 to 6 GHz	1.17	1.18
U2000H	10 MHz to 8 GHz	1.15	1.17
	8 to 12.4 GHz	1.25	1.26
	12.4 to 18 GHz	1.28	1.29
U2001H	10 MHz to 6 GHz	1.15	1.17
U2002H	50 MHz to 8 GHz	1.15	1.17
	8 to 12.4 GHz	1.25	1.26
	12.4 to 18 GHz	1.28	1.29
	18 to 24 GHz	1.30	1.31

Ordering Information

U2000 Series USB power sensors
V3500A handheld RF power meter

Web Link

www.agilent.com/find/powermeters



53200 Series



53100 Series

Frequency Counters

Starting with the first frequency-measurement projects in the 1940s, Hewlett-Packard established the major technologies enabling today's frequency counters. Today, Agilent Technologies offers a broad family of frequency counters and counter/timers. Frequency counters are used throughout many technical industries for measuring and analyzing frequency, phase, and time-interval signal characteristics. The breadth of the Agilent offering allows the best product to be selected for each application.

RF Counters

The 53210A RF counter is the newest generation RF counter offering frequency and period measurements over the range of DC to 350 MHz with exceptional resolution of 10 digits in one second. An optional second channel increases the frequency range to 6 or 15 GHz, making it easy to cover your exact RF measurement needs. Other features of the 53210A include LAN, USB and optional GPIB, automatic limit testing, extensive in-box statistical and math analysis, and more. The well known 53181A offers an RF counter with a range up to 225 MHz for frequency and period measurements.

Universal Frequency and Time Interval Counters

The new 53220A and 53230A universal frequency counters incorporate frequency measurements similar to the RF counters as well as additional capabilities for time-interval measurements. Specifically these counters measure precise timing between two trigger events. These high performance universal products also provide complete, automatic characterization of rise time, pulse width, and other signal parameters.

Frequency counters are depended on in R&D and in manufacturing for the fastest, most accurate frequency and time interval measurements. The 53220A and 53230A universal frequency counters expand on this expectation and allow you to get the most information, connectivity and new measurement capabilities while building on the speed and accuracy you've depended on with Agilent's decades of time and frequency measurement experience.

The Agilent frequency counter offering includes four high-performance universal counters: the new 53220A and 53230A and the well known 53131A and 53132A counters.

Microwave and Millimeter-Wave Frequency Counters

These products provide fundamental high performance frequency measurements, DC to 46 GHz. Many enhancements are built in or available as options such as power measurement, battery operation, and high-accuracy time bases.

53150A/53151A/53152A: Portable CW microwave counter with power measurement for telecommunications service

53147A/53148A/53149A: Portable CW microwave counter with DC DVM plus true power meter for improved power accuracy

High-Precision Oscillators

The accuracy of frequency and time interval measurements is vitally dependent on the time base or reference element selected. Agilent has pioneered the field of high-precision crystal oscillators. The current counter product line benefits from Agilent's leadership in quality and precision oscillator technology. Three oscillator varieties are standard or optional with Agilent counters and counter/timers: Room-temperature crystal oscillators (RTXO), temperature-compensated oscillators (TCXO), and oven time base.

Universal and RF Counter Selection Guide

Model	Frequency range (extension)	Frequency resolution (1s gate time)	Best sensitivity	Time-interval resolution (single-shot LSD)	Additional features
Universal counters					
53220A optional 3 rd channel	350 MHz (6 or 15 GHz)	12 digits	7 mVrms	100 ps	53220A and 53230A: USB, LAN, GPIB (Option), graphical display, 1 M reading memory 53230A: Continuous/gap-free measurements, optional pulse microwave 53131A and 53132A: GPIB and RS232
53230A optional 3 rd channel	350 MHz (6 or 15 GHz)	12 digits	7 mVrms	20 ps	
53131A optional 3 rd channel	225 MHz (3.5, 12.4 GHz)	10 digits	20 mVrms	500 ps	
53132A optional 3 rd channel	225 MHz (3.5, 12.4 GHz)	12 digits	20 mVrms	150 ps	
RF counters					
53210A optional 2 nd channel	350 MHz (6 or 15 GHz)	10 digits	7 mVrms	—	53210A: USB, LAN, GPIB (Option) 53181A: GPIB and RS232
53181A optional 2 nd channel	225 MHz (1.5, 3, 5, 12.4 GHz)	10 digits	20 mVrms	—	
CW microwave counters					
53150A	20 GHz	1 Hz	-30 dBm	—	Applies to all: GPIB standard, battery optional, simultaneous power measurement
53151A	26.5 GHz	1 Hz	-30 dBm	—	
53152A	46 GHz	1 Hz	-30 dBm	—	
CW microwave counter, power meter, DVMs					
53147A	20 GHz	1 Hz	-30 dBm	—	Applies to all: DVM and GPIB standard battery optional, -70 dBm to +20 dBm true power meter
53148A	26.5 GHz	1 Hz	-30 dBm	—	
53149A	46 GHz	1 Hz	-30 dBm	—	

Web Link

www.agilent.com/find/counters

53220A
53230A
53131A
53132A
53210A
53181A

- 225 and 350 MHz basic bandwidth
- Optional 6 or 15 GHz channel (53200 Series)
- 10 and 12-digit per second
- 20 ps single shot time interval resolution (53200 Series)
- Built in math and statistics
- Automated limit testing
- Popular interfaces; LAN, USB, GPIB and RS-232



53200 Series frequency counters

A Full Family of High-Performance RF and Universal Counters

Imagine Your Counter Doing More

The choice of Agilent's high-performance counters offer exceptional performance and price in a rugged, lightweight package with a unique combination of ease of use, complete measurement set, extensive analysis capability, reliability, and high measurement and data transfer speed. These instruments use real-time digital signal processing technology to analyze data while simultaneously taking new readings, speeding measurement throughput. The technology allows the counters to gather more data for each measurement so you get the high-resolution measurements in a fraction of the time it takes a conventional counter.

Powerful Analysis Capability

The family of 53220A/53230A and 53131A/53132A counters offer built-in statistics and math functions so you can scale measurements and simultaneously measure and track average, minimum/maximum and standard deviation. Automated limit testing lets you set upper and lower limits for any measurement. When a measurement falls outside those limits, the counters log the out-of-limit conditions, notify the operator and generate an output signal to trigger external devices or stop the test. A graphical display mode carries limit testing one step further, letting you see at a glance whether a measurement falls within pass/fail limits.

High-Speed Automated Test Capability

The new 53220A and 53230A are faster by design offering exceptional bandwidth, 350 MHz baseband frequency, and an optional 6 or 15 GHz microwave channel. The 53230A offers high resolution with 12 digits/second and a faster single shot time interval measurement of 20 ps. For ultimate flexibility of computer-controlled systems applications, the counters offer standard LAN, USB and an optional GPIB interface. A new datalogging capability allows saving up to 1 M readings at up to 75,000 frequency readings/second. You can transfer readings from memory via LAN or USB as fast as 1 M readings in 2 s. The 53230A offers high-speed

measurement capability with continuous gap-free measurements, basic modulation domain analysis (MDA) and timestamp as well as an optional pulse microwave measurements. The standard commands for programmable instruments (SCPI) protocol works easily with the counters letting you leverage your programming investment across your measurement system.

53210A and 53181A RF Counters

Optimized for RF applications, these single-channel counters give you frequency, period, and peak-voltage measurements with up to 10 digits/sec frequency and period resolution. The counters are ideal for bench top, system RF and analog applications. A digit-blanking function lets you easily eliminate unnecessary digits when you want to read measurements quickly. For higher frequency measurements, an optional second channel provides 6 or 15 GHz for the 53210A or 1.5, 3, 5 or 12.4 GHz for the 53181A.

53220A, 53230A and 53131A, 53132A Frequency Counters

These two-channel universal counters offer up to 12 digits per second of frequency and period resolution for bandwidths up to 350 MHz. Single shot time interval measurements can be resolved down to 20 psec. Measurements include frequency, time interval, ratio, period, phase angle, totalize, peak voltage, pulse parameters and more. For quick access to frequently used tests, a single keystroke recalls up to 20 different stored front-panel set-ups.

For applications requiring higher resolution the 53230A offers the same features and functions as the 53220A with 12 digits/second frequency and period resolution and with single shot time interval resolution of 20ps. Choose the 53230A when you need to very best in accuracy and resolution, or when speed in an automated system is critical. With the 53230A, continuous gap-free measurements, basic modulation domain analysis (MDA) and timestamp as well as an optional pulse microwave measurements are possible.

The new 53220A and 53230A counters have built in compatibility capability with Agilent 53131A/53132A frequency counters. Select 53131A/53132A family compatibility mode for full SCPI compatibility with Agilent's previous generation of counters. The optional GPIB connectivity allows for full use of your existing Agilent 53131A/53132A counter programs.

Options Increase Versatility

The 53220A, 53230A, 53131A and 53132A counters can be ordered with an optional RF-input channel to provide frequency measurements up to 15 GHz (53220A/53230A) and 12.4 GHz (53131A/53132A).

A choice of optional timebases is available for the counters to increase your measurement accuracy. The 53220A and 53230A expand the capabilities beyond what has traditionally been available in standard frequency counters. The new 53220A/53230A counters offer a large display with configurable graphic views of trend lines, strip charts, and histograms. Markers allow you to zoom in to the data you need and can also select specific measurement values from trend and histogram charts. Colored limit lines allow you to set up your pass/fail boundaries and easily determine from the front panel when measurements have surpassed those thresholds. Use math with built in statistics and analysis to analyze data quickly. These options and more enable you to configure the counters and measure data quickly and easily.

Specifications

Abridged measurement specifications and characteristics

	53210A RF counter 1 channel	53181A RF counter 1 channel	53220A/53230A universal frequency counter/ timer 2 channel	53131A/53132A universal frequency counter/ timer 2 channel
Frequency bandwidth and resolution	DC-350 MHz, 10-digit/s	DC-225 MHz, 10-digits	DC-350 MHz 12 digit/s, 100 ps (53220A) 12 digit/s, 20 ps (53230A)	DC-225 MHz 10-digit/s, 500 ps (53131A) 12-digit/s, 150 ps (53132A)
Inputs				
Impedance, coupling	1 MΩ or 50Ω, DC or AC coupling			
Amplitude input range	±5 V (±50 V) full scale ranges			
Frequency range	Option 106: 100 MHz – 6 GHz or Option 115: 300 MHz – 15 GHz	Option 015: 100 MHz – 1.5 GHz	Option 106: 100 MHz – 6 GHz or Option 115: 300 MHz – 15 GHz	Option 030: 100 MHz – 3 GHz Option 050: 200 MHz – 5 GHz Option 124: 200 MHz – 12.4 GHz
Amplitude range	Option 106: autoranged to +19 dBm max. (2 Vrms) Option 115: autoranged to +15 dBm max. (1.25 Vrms)	Option 015: –27 dBm to +19 dBm (5 Vrms) Option 030: –27 dBm to +19 dBm (100 MHz to 2.7 GHz) –21 dBm to +13 dBm (2.7 to 3 GHz) Option 050: –23 dBm to +13 dBm Option 124: –23 dBm to +13 dBm	Option 106: autoranged to +19 dBm max. (2 Vrms) Option 115: autoranged to +15 dBm max. (1.25 Vrms)	Option 030: –27 dBm to +19 dBm (100 MHz to 2.7 GHz) –21 dBm to +13 dBm (2.7 to 3 GHz) Option 050: –23 dBm to +13 dBm Option 124: –23 dBm to +13 dBm
Measurement range				
Time interval resolution	n/a	n/a	100 ps (53220A) 20 ps (53230A)	500 ps (53131A) 150 ps (53132A)
Measurement technique	Reciprocal	Reciprocal	Reciprocal and resolution enhanced Continuous/gap-free (for frequency and averaged period) (53230A only)	Reciprocal and resolution enhanced
Measurements	Frequency, period, frequency ratio, level	Frequency, period, frequency ratio (w/opt Ch 2), level	Frequency, period, frequency ratio, time interval, single period, rise/fall time, pulse width, duty cycle, phase, totalize, level, timestamp/MDA (53230A only) Option pulse microwave (53230A only)	Frequency, period, frequency ratio, time interval, rise/fall time, pulse width, duty cycle, phase, totalize, level
Burst/pulse microwave measurements	n/a	n/a	Optional carrier frequency, PRI, PRF, PW (53230A only) continuous/gap free, timestamping/basic MDA capabilities (53230A only)	n/a
Gate source	Time, external	Auto, manual, external, delay	Time, external, advanced (gate start, stop/hold-off time or events)	Auto, manual, external, delay
Trigger characteristics				
Source	Internal, external, bus	Auto, timed, digits, external, time interval delayed	Internal, external, bus	Auto, timed, digits, external, time interval delayed
Trigger count & samples/ trigger	1 to 1,000,000	2 to 1,000,000	1 to 1,000,000	2 to 1,000,000
Trigger delay	0 to 3600 s in 1 μs steps		0 to 3600 s in 1 μs steps	100 ns to 10 s (53132A)

Ordering Information

53210A 350 MHz, 10-digit/s RF frequency counter

53220A 350 MHz, 12-digit/s, 100 ps universal frequency counter/timer

53230A 350 MHz, 12-digit/s, 20 ps universal frequency counter/timer

All models include power cord, documentation CD with quick reference guide, operating guide, programming guide, and example programs Agilent IO Library CD and IVI-COM instrument driver software.

53131A 10-digit/s, 500 ps universal counter

53132A 12-digit/s, 150 ps universal counter

53181A 10-digit/s RF counter

All models include IntuiLink software, standard timebase, power cord, operating, programming and service manuals.

Please see product web page and datasheet for details of options and accessories.

Web Link

www.agilent.com/find/counters

53220A
53230A
53131A
53132A
53210A
53181A

53150A
53151A
53152A
53147A
53148A
53149A

- Ultrawide range, single input (from 50 MHz up to 46 GHz)
- Simultaneous power and frequency measurement with analog peaking indicator
- Lightweight and rugged
- Battery optional
- Fully programmable via GPIB and RS-232 interfaces



53150A, 53151A, 53152A Microwave Counters

The Agilent 53150 Series offer no-compromise performance and quality while attaining true portability. The 53150A, 53151A and 53152A measure both frequency and power over the frequency ranges of 20 GHz, 26.5 GHz, and 46 GHz, respectively, and feature a single extremely wideband microwave input (50 MHz up to 46 GHz).

No Compromise Performance

Utilizing a unique single board design with low phase noise PLL circuitry, the 53150 Series offers exceptional sensitivity, excellent power measurement accuracy and repeatability as well as fast acquisition times and full programmability.

Specifications

53150 Series

Input characteristics

	Input 1 (1 MΩ)	Input 2 (50 Ω)
Frequency range		
53150A	10 Hz – 125 MHz	50 MHz – 20 GHz
53151A	10 Hz – 125 MHz	50 MHz – 26.5 GHz
53152A	10 Hz – 125 MHz	50 MHz – 46 GHz

	Input 1 (1 MΩ)	Input 2 (50 Ω)	
		53150/51	53152

Sensitivity			
10 – 30 Hz	40 mVrms	–	–
30 Hz – 125	25 mVrms	–	–
50 – 300 MHz	–	–20 dBm	–20 dBm
0.3 – 12.4 GHz	–	–33 dBm	–33 dBm
12.4 – 18 GHz	–	–33 dBm	–30 dBm
18 – 20 GHz	–	–29 dBm	–27 dBm
20 – 26.5 GHz	–	–25 dBm (151)	–27 dBm
26.5 – 40 GHz	–	–	–23 dBm
40 – 46 GHz	–	–	–17 dBm

Power measurement

- Range: counter sensitivity to +7 dBm
- Units: dBm or milliwatts/microwatts
- Resolution: 0.01 dB

Accuracy* (0 to –20 dBm):

	53150/51	53152
< 12.4 GHz	±1.5 dB	±1.0 dB
To 20 GHz	±1.5 dB	±1.5 dB
To 26.5 GHz	±2.0 dB (151)	±1.5 dB
To 46 GHz	–	±2.0 dB

* At channel two input connector

Ordering Information

53150A 20 GHz counter
53151A 26.5 GHz counter
53152A 46 GHz counter

- Choice of frequency counter ranges up to 46 GHz
- True power meter with 8480 Series sensors
- DVM standard and optional battery
- GPIB and RS-232 interfaces



53147A, 53148A, 53149A Microwave Counter/Power Meter/DVMs

The Agilent 53140 Series microwave counter/power meter/DVMs have all the fundamental measurements required to install and maintain today's digital microwave radio links as well as ATE applications. Rugged field portability and a battery option complete the ensemble.

Specifications

53140 Series

Input Characteristics

	Input 1 (1 MΩ)	Input 2 (50 Ω)
Frequency range		
53147A	10 Hz – 125 MHz	50 MHz – 20 GHz
53148A	10 Hz – 125 MHz	50 MHz – 26.5 GHz
53149A	10 Hz – 125 MHz	50 MHz – 46 GHz

	Input 1 (1 MΩ)	Input 2 (50 Ω)	
		53147/48	53149

Sensitivity			
10 – 30 Hz	40 mVrms	–	–
30 – 125 Hz	25 mVrms	–	–
50 – 300 MHz	–	–20 dBm	–20 dBm
0.3 – 12.4 GHz	–	–33 dBm	–33 dBm
12.4 – 18 GHz	–	–33 dBm	–30 dBm
18 – 20 GHz	–	–29 dBm	–27 dBm
20 – 26.5 GHz	–	–25 dBm (148)	–27 dBm
26.5 – 40 GHz	–	–	–23 dBm
40 – 46 GHz	–	–	–17 dBm

Damage Level	5 Vrms to 120 Vp	+27 dBm
---------------------	------------------	---------

Channel 1

- Resolution: selectable 1 Hz to 1 MHz
- Low pass filter: 50 KHz, selectable

Channel 2

- Resolution: selectable 1 Hz to 1 MHz
- Acquisition time: 100 to 140 ms
- Gate time: 1/resolution

Power meter specifications

- Frequency range: 10 MHz to 50 GHz, sensor-dependent
- Power range: –70 dBm to +44 dBm, sensor-dependent
- Power sensors: 8480 Series

Ordering Information

53147A 20 GHz counter/power meter/DVM
53148A 26.5 GHz counter/power meter/DVM
53149A 46 GHz counter/power meter/DVM

Web Link

www.agilent.com/find/counters

- A flexible and intuitive user interface
- Easy measurement setup
- Low instrument uncertainty
- Color graphical display of noise figure and gain versus frequency
- Enhanced PC and printer connectivity
- SNS, 346 and 347 Series noise source compatible
- Ability to automatically upload ENR calibration data from SNS Series noise source
- Local oscillator control through second dedicated GP-IB

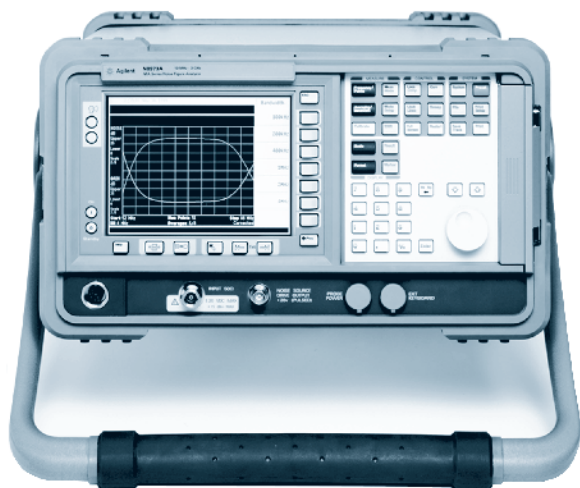

N8973A

NFA Series

Easy Measurement Setup

The NFA Series of noise figure analyzers now takes the pain out of complex measurement setups, with their simple but instructive menus. The built-in help button gives key function and remote programming commands, that should eliminate the need to carry manuals when setting up measurements.

Low Instrumentation Uncertainty

When making noise figure measurements, a key parameter to be aware of is measurement uncertainty. The NFA has a low instrumentation uncertainty to aid in accurate and repeatable measurement of manufacturers' components. In addition, to aid customers in setting their components/systems specifications, Agilent has produced a web-based uncertainty calculator that will give customers information on how to improve and classify their measurement specifications more accurately.

For more information, visit our web site at: www.agilent.com/find/nf

Color Graphical Display

To enhance usability, the noise figure analyzers come with an integrated 17 cm full color LCD display, for simultaneous viewing of noise figure and gain against frequency. There are three different formats for viewing measurements, the two separate channel or combined graph format, a table format, and a spot frequency noise figure and gain measurement "meter" format.

Ease of Automation

The NFA Series of noise figure analyzers include 2 industry-standard GPIB ports and an RS232 serial port, to aid in the automated control of the instrument. The second GPIB port is dedicated to local oscillator control. The default control language is SCPI, but users can also define custom LO commands.

Full Measurement Capability

Features present in all NFA Series noise figure analyzers

- ENR data automatically loaded into NFA Series noise figure analyzer when using SNS noise source
- Floppy disk loading and saving of ENR data when used with a 346 or 347 noise source
- Enhanced analysis through Limit lines and Marker functions
- Enhanced PC and printer connectivity and VGA output
- Internal data storage capable of storing up to 30 different state, trace, and setup files (dependent upon measurement complexity)
- 4 MHz measurement bandwidth
- Frequency list mode, which enables the user to avoid known, polluted frequencies during a measurement or, used tactically to speed up a measurement

Features Available

- Lower noise figure measurement uncertainty ± 0.05 dB
- Six user selectable bandwidths (100 KHz, 200 KHz, 400 KHz, 1 MHz, 2 MHz, and 4 MHz)

NFA Series Key Specifications

Specifications apply over 0 to +55 °C unless otherwise noted. The analyzer will meet its specifications after 2 hours of storage within the operating temperature range, 60 minutes after the analyzer is turned on, with Alignment running. A user calibration is required before corrected measurements can be made.

Frequency range

- NFA Series:**
- N8973A** 10 MHz to 3 GHz
 - N8974A** 10 MHz to 6.7 GHz
 - N8975A** 10 MHz to 26.5 GHz

Measurement speed (nominal)

	8 averages	64 averages
N8973A	< 50 ms/measurement	< 42 ms/measurement
N8974A	< 70 ms/measurement	< 50 ms/measurement
N8975A	< 70 ms/measurement	< 50 ms/measurement

Measurement bandwidth (nominal)

N8973A, N8974A, N8975A: 4 MHz, 2 MHz, 1 MHz, 400 kHz, 200 kHz, 100 kHz

Noise figure and gain

(Performance is dependent upon ENR of noise source used)

N8973A, N8974A and N8975A (10 MHz to 3.0 GHz)	Noise source ENR		
	4 – 7 dB	12 – 17 dB	20 – 22 dB
Noise figure			
Measurement range	0 to 20 dB	0 to 30 dB	0 to 35 dB
Instrument uncertainty	± 0.05 dB	± 0.05 dB	± 0.1 dB
Gain			
Measurement range	-20 to +40 dB		
Instrument uncertainty	± 0.17 dB		

N8974A and N8975A (> 3.0 GHz)	Noise source ENR		
	4 – 7 dB	12 – 17 dB	20 – 22 dB
Noise figure			
Measurement range	0 to 20 dB	0 to 30 dB	0 to 35 dB
Instrument uncertainty	± 0.15 dB	± 0.15 dB	± 0.2 dB
Gain			
Measurement range	-20 to +40 dB		
Instrument uncertainty	± 0.17 dB		

N8973A
N8974A
N8975A

Characteristic noise figure at 23 °C ± 3 °C (10 MHz to 3.0 GHz)

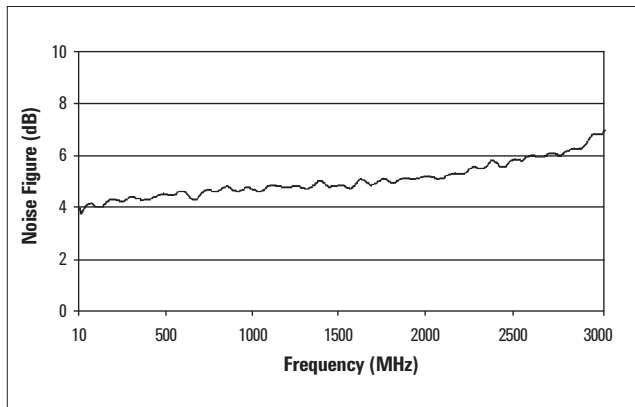

Characteristic noise figure at 23 °C ± 3 °C (3.0 to 26.5 GHz)

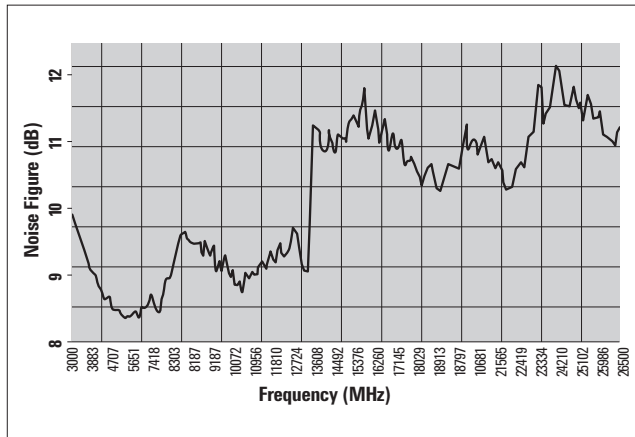

Characteristic values are met or bettered by 90% of instruments with 90% confidence.

Frequency reference

	Standard	Option 1D5
Ageing	±< 2 ppm ¹ /year	±< 0.1 ppm/year
Temperature stability	±< 6 ppm	±< 0.01 ppm
Settability	±< 0.5 ppm	±< 0.01 ppm

Tuning accuracy (start, stop, center, marker)

4 MHz measurement bandwidth (default on all models of noise figure analyzer)

Frequency	Error
10 MHz – 3.0 GHz	±< Reference error + 100 kHz
3.0 – 26.5 GHz	±< Reference error + 400 kHz

<4 MHz measurement bandwidth

Frequency	Error
10 MHz – 3.0 GHz	±< Reference error + 20 kHz
3.0 – 26.5 GHz	±< Reference error + 20% of measurement bandwidth

General Specifications

Dimensions

- Without handle: 222 mm H x 375 mm W x 410 mm D
- With handle (max): 222 mm H x 409 mm W x 515 mm D

Weight (typical, without options)

- **N8973A:** 15.5 kg
- **N8974A:** 17.5 kg
- **N8975A:** 17.5 kg

Data storage (nominal)

- Internal drive: 30 traces, states or ENR tables
- Floppy disk: 30 traces, states or ENR tables

Power requirements

- On (line 1): 90 to 132 V rms, 47 to 440 Hz, 195 to 250 V rms, 47 to 66 Hz
- Power consumption: < 300 W
- Standby (line 0): < 5 W

Temperature range

- Operating: 0 to +55 °C
- Storage: -40 to +70 °C

Humidity range

- Operating: up to 95% relative humidity to 40 °C (non-condensing)
- Altitude range: operating to 4,600 meters

Calibration interval

- 1-year minimum recommended

Electromagnetic compatibility

- Complies with the requirements of the EMC directive 89/336/EEC. This includes Generic Immunity Standard EN 50082-1:1992 and Radiated Interference Standard CISPR 11:1990/EN 55011:1991, Group 1 Class A. The conducted and radiated emissions performance typically meets CISPR 11:1990/EN 55011:1991 Group 1 Class B limits.

Warranty

- 1-Year warranty as standard

Ordering Information

N8973A 10 MHz to 3.0 GHz NFA Series noise figure analyzer

N8974A 10 MHz to 6.7 GHz NFA Series noise figure analyzer

N8975A 10 MHz to 26.5 GHz NFA Series noise figure analyzer

All options, other than those marked with *, can be ordered at any time for use with an instrument.

Frequency reference

N897xA-1D5 NFA Series high stability frequency reference*

Calibration documentation

N897xA-A6J NFA Series ANSI Z540 compliant calibration with test data*

Calibration¹

For 3 years, order 36 months of the appropriate calibration plan shown below. For 5 years, specify 60 months.

R-50C-001 standard calibration plan*

R-50C-002 standard compliant calibration plan*

¹ Options not available in all countries

Note: The localized options will include a localized version of the quick reference guide and user guide, and an English language version of the programmers reference, and calibration and performance verification manual

Web Link

www.agilent.com/find/nf

- Agilent noise sources with frequency range from 10 MHz to 50 GHz
- Excess noise ratio (ENR) selected for a variety of user applications
- SNS series of noise sources have stored ENR data, decreasing the opportunity for user error



SNS Series

SNS Series Noise Sources

The Agilent SNS Series of noise sources work in conjunction with the Agilent NFA Series of noise figure analyzers to simplify measurement set-up and improve accuracy. When connected to the Agilent, NFA Series, the noise source automatically downloads electronically stored calibration data to the analyzers. The SNS Series also connects to Agilent's ESA spectrum analyzers, or MXA and EXA signal analyzers. The noise sources also have the capability to automatically measure their own temperature so that compensation can be applied to the calibration data. These capabilities increase the overall reliability and accuracy of the noise figure measurement. The SNS noise sources can be used for a various applications with a range of frequencies, excess noise ratio (ENR) and coaxial connector types.

SNS Series Partial Specifications

Instrument model	Frequency range	ENR value
N4000A	10 MHz to 18 GHz	4.5 – 6.5 dB
N4001A	10 MHz to 18 GHz	14 – 16 dB
N4002A	10 MHz to 12 GHz 12 to 26.5 GHz	12 – 16 dB 14 – 17 dB

Instrument model	Frequency range (GHz)	Max SWR	Reflection coefficient
N4000A	0.01 to 3.0	< 1.04	0.02
	3.0 to 7.0	< 1.13	0.06
	7.0 to 18.0	< 1.22	0.10
N4001A	0.01 to 3.0	< 1.15	0.07
	3.0 to 7.0	< 1.20	0.09
	7.0 to 18.0	< 1.25	0.11
N4002A	0.01 to 3.0	< 1.22	0.10
	3.0 to 7.0	< 1.25	0.10
	7.0 to 18.0	< 1.25	0.11
	18.0 to 26.5	< 1.35	0.15

Ordering Information

N4000A SNS Series noise source, 10 MHz to 18 GHz, nominal ENR 6 dB
N4001A SNS Series noise source, 10 MHz to 18 GHz, nominal ENR 15 dB
N4002A SNS Series noise source, 10 MHz to 26.5 GHz, nominal ENR 15 dB
 All of the SNS Series noise sources are provided with an APC 3.5 (male) connector as standard.

Connector

N400xA-001 type-N (m) connector

Custom solution

N400xA-H10 gold standards calibration (for use with the N2002A)

Service Options: warranty and service

Standard warranty is 1 year.

For warranty and service of 3 years, please order R-51B-001-3C: "1 year Return-to-Agilent warranty extended to 3 years" (quantity = 1).

Calibration¹

For 3 years, order 36 months of the appropriate calibration plan shown below. For 5 years, specify 60 months.

R-50C-001 standard calibration plan

R-50C-002 standard compliant calibration plan



346A/B/C broadband noise sources

346 Series Noise Sources

The Agilent 346 Series of noise sources work in conjunction with the Agilent NFA Series noise figure analyzer, the X-Series signal analyzers, the PSA, and the ESA spectrum analyzers to make accurate and reliable noise figure measurements. Each 346 noise source has individually calibrated ENR values at specific frequencies. The calibration data is printed on the label of the noise source and can be manually entered into the NFA, X-Series, PSA, or ESA. A floppy disk is also provided with the calibration data, for rapid entry of ENR data into the NFA, X-Series, PSA, or ESA. The 346 noise sources are designed for a broad range of measurement applications, with a range of frequencies, excess noise ratio (ENR) and coaxial connector types.

Customer Solution Noise Sources

346B with Option 346B-H01 high ENR noise source

The 346B-H01 has high ENR (21 dB typical), suitable for measuring high noise figure devices.*

346B with Option 346B-H42 DBS noise source

The 346B-H42 was developed especially to test low noise block converters (LNB) used for direct broadcast satellite (DBS). WR75 waveguide output, 5 dB ENR, low ENR calibration uncertainty, and low SWR improve the noise figure measurement accuracy of DBS LNBs.*

346C-K01 broadband noise source

This coaxial noise source features coverage from 1 to 50 GHz with the 2.4 mm coaxial connector. ENR is nominally 20 dB at 1 GHz and 7 dB at 50 GHz.*

346 Series Partial Specifications

Instrument model	Frequency range	ENR value
346A	10 MHz to 18 GHz	4.5 – 6.5 dB
346B	10 MHz to 18 GHz	14 – 16 dB
346C	10 MHz to 12 GHz	12 – 16 dB
	12 to 26.5 GHz	14 – 17 dB

Instrument model	Frequency range (GHz)	Max SWR	Reflection coefficient
346A/B	0.01 to 3.0	1.3	0.13
	3.0 to 5.0	1.15	0.07
	5.0 to 18.0	1.25	0.11
346C	0.01 to 18.0	1.25	0.11
	18.0 to 26.5	1.35	0.15

¹ Option not available in all countries

* Contact Agilent for technical specifications

SNS Series
346 Series
N2002A

SNS Series
346 Series
N2002A

Ordering Information

346A 10 MHz to 18 GHz 346 Series noise source nominal ENR 5 dB
346B 10 MHz to 18 GHz 346 Series noise source nominal ENR 15 dB
346C 10 MHz to 26.5 GHz 346 Series noise source nominal ENR 15 dB
 All of the 346 Series noise sources are provided with an APC 3.5 (male) connector as standard.

Connectors (excludes 346C)

346x-001 type N (male) connector
346x-002 APC-7mm connector
346x-004 type N (female) connector

Calibration documentation

346x-A6J ANSI Z540 compliant calibration with test data

Additional documentation

346x-910 extra operation manual

Custom solution Options

346x-H10 gold standards calibration (for use with the N2002A)
346B-H01 APC 3.5(m) connector with 21 dB nominal ENR
346B-H42 DBS waveguide adapter and nominal ENR 5 dB
346CK01 1 to 50 GHz 346 Series noise source nominal ENR 21 dB

Service Options: warranty and service

Standard warranty is 1 year.
 For warranty and service of 3 years, please order R-51B-001-3C: "1 year Return-to-Agilent warranty extended to 3 years" (quantity = 1).

Calibration¹

For 3 years, order 36 months of the appropriate calibration plan shown below. For 5 years, specify 60 months.
R-50C-001 standard calibration plan
R-50C-002 standard compliant calibration plan

R347B and Q347B Noise Sources

This series of broadband noise sources has been designed to cover high frequency waveguide measurement applications.

Agilent 347 Partial Specifications

Instrument model	Frequency range	ENR value
R347B	26.5 to 44 GHz	10 – 13 dB
Q347B	33 to 42 GHz 42 to 50 GHz	10 – 13 dB 6 – 12.5 dB

Instrument model	Frequency range (GHz)	Max SWR	Reflection coefficient
R347B	26 to 44	< 1.42	0.17
Q347B	33 to 50	< 1.57	0.22

Warranty

1-Year warranty as standard

- Simple calibration of noise sources with reduced uncertainty
- Traceable results to a national standard
- Availability for engineers who require on-site calibration



N2002A Noise Source Test Set

The N2002A noise source test set offers customers the opportunity to calibrate their own noise sources with minimal levels of uncertainty. With simple straightforward operations and low cost of equipment it is now viable that this process can occur "in-house" and thus drastically reduces downtime.

For engineers that currently run their own noise source calibration service, the N2002A noise source test set is an ideal addition to their test equipment. By incorporating this low-cost, self-contained unit into a wider noise source calibration system, high quality calibrations of noise sources can be made. When used within a noise source calibration system the N2002A and Agilent N8975A NFA Series noise figure analyzer can also drastically reduce the calibration time.

Ordering Information

N2002A noise source test set

Accessories

N2002A-001

Accessory cable and adapters
 Cable (x1): 11500E
 3.5 mm female to female adapter (x 3): 1250-1749
 3.5 mm female to type-N (female) adapter (x1): 1250-1745

Warranty

1-Year warranty as standard

¹ Option not available in all countries

Web Link

www.agilent.com/find/nf

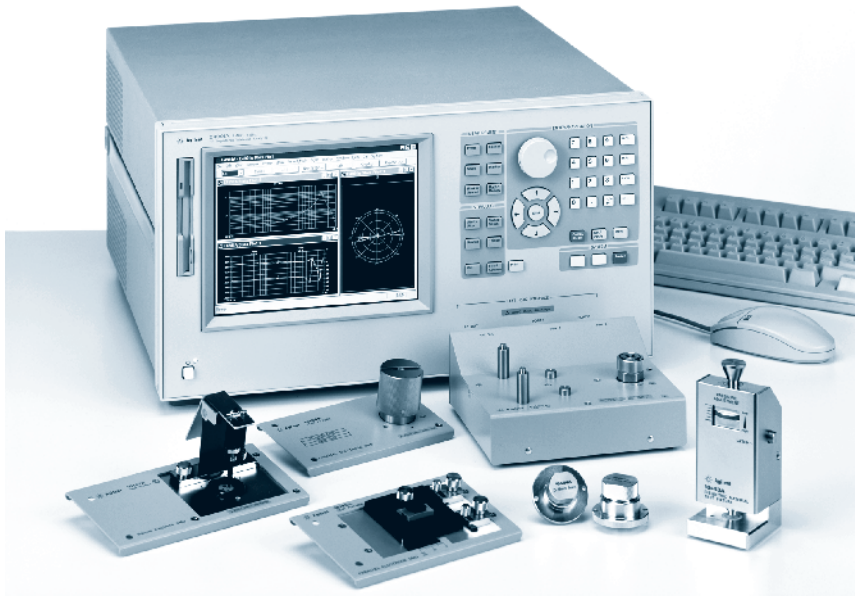

Permittivity ($\epsilon^* = \epsilon' - j \epsilon''$) and permeability ($\mu^* = \mu' - j \mu''$) are complex values. The real part (ϵ' or μ') is a measure of how much energy is stored in a material. The imaginary part (ϵ'' or μ'') is a measure of how much energy is lost in a material. These properties are not constant and may change with frequency or temperature, for example. Accurate measurements of these material properties during characterization or inspection help to achieve the best performance for a given application while shortening design cycles and minimizing scrap.

A materials measurement system consists of an instrument, a fixture to hold the material, and software or firmware to calculate complex permittivity or permeability values and display the results. For material testing applications, Agilent currently offers three types of solutions: LCR meter-based, impedance analyzer-based, and network analyzer-based systems.

Agilent offers fixture accessories based on the open-ended coaxial probe, the transmission line measurement, the parallel plate capacitance, and the inductor impedance technique. These choices allow you to best match the fixture, frequency range, and measurement technique with your material's physical and electrical test requirements. The chart of material test applications and solutions is shown in the next page 150.

Component Measurement

Today's electronic components are designed for higher performance, while being reduced in size, power consumption, and cost. Efficient and accurate component characterization, design evaluation, and manufacturing test are critical to the success of component users and suppliers. Agilent Technologies offers the industry's broadest line of component test instruments for passive as well as active components. The products in this section are designed to measure fundamental impedance-related parameters of electronic components and materials.

Impedance Measuring Instruments

Impedance measuring instruments can be divided into two general categories: LCR meters and impedance analyzers. LCR meters primarily measure inductance, capacitance, and resistance of the test device at spot frequencies. Impedance analyzers, in addition to all the functions of the LCR meter, measure impedance, phase, and sometimes

transmission parameters. These analyzers have extended frequency range, a synthesized source, swept frequency capability, and excellent frequency resolution. Combination network/spectrum/impedance analyzers offer the benefits of impedance analysis as well as vector-network and spectrum analysis. See the selection guides that follow for general instrument capabilities. For higher frequencies (above 3 GHz) in a 50 Ω environment, a dedicated vector-network analyzer is the best solution for impedance measurements. See network analyzers.

Selecting a test fixture is as important as selecting the right instrument. Agilent offers a wide range of accessories for axial, radial, and SMD chip devices. See page 151.

Materials Measurements

Materials have two properties that determine how they interact with electromagnetic fields:

- Permittivity (ϵ) or dielectric constant for electric fields
- Permeability (μ) for magnetic fields

Signal Source Device Test

Agilent provides an excellent performance analyzer for evaluating nearly all types of RF and microwave signal source device such as crystal oscillators, VCOs, DROs, RFICs, and PLL synthesizers. The Agilent signal source analyzer is the single instrument solution enabling phase noise, frequency, power, DC current, and frequency/phase/power over time measurements. See page 159 for the Agilent signal source analyzer.

Impedance Analyzer Selection Guide

Model	Frequency range	Impedance range/other	Additional information	Page
4294A	40 Hz to 110 MHz	25 m Ω to 40 M Ω *	Color display, equivalent circuit analysis, IBASIC, LAN I/F, SMD fixtures	152
E4991A	1 MHz to 3 GHz	200 m Ω to 20 k Ω	Color display, VBA, SMD fixtures, equivalent circuit analysis, material, LAN I/F, temperature characteristic measurement	153

* 10% accuracy range

LCR and Resistance Meter Selection Guide

Model	Frequency range	Impedance range*/ other	Additional information	Page
4263B	100 Hz to 100 kHz (5 test frequencies)	1 mΩ to 100 MΩ	Optional transformer test	154
E4980A	20 Hz to 2 MHz	0.001 fΩ to 999.9999 TΩ	42841A for high-current dc bias	154
4285A	75 kHz to 30 MHz (100 Hz steps)	0.01 mΩ to 100 MΩ	42841A for high-current dc bias	155
4287A	1 MHz to 3 GHz (100 kHz steps)	200 mΩ to 3 kΩ	Higher-accuracy, higher-speed RF LCR meter	155
E4981A	120 Hz/1 kHz/1 MHz	0.00000 pF to 2 mF	High speed capacitor test	156
4338B	1 kHz test signal	10 μΩ to 100 kΩ	Milliohmmeter	157
4339B	DC	1 kΩ to 1.6 x 10 ¹⁶ Ω	High-resistance meter, volume and surface resistivity, current	157

* Refer to the product data sheet for more details

Material Test Applications and Solutions

	DC resistivity cell (16008B)	Dielectric test fixture (16451B)	Liquid dielectric test fixture (16452A)	Dielectric and magnetic test fixtures (16453A) (16454A)	Dielectric probe system (85070M)	Agilent material measurement software (85071B)
Absorber					•	•
Ceramic	•	•		•	•	
Fermentation					•	
Film (thin)		•		•		
Food					•	
Gel, semi-solid					•	
Liquid			•		•	
Loss		•	•	•	•	
Permeability				•		•
Permittivity (dielectrics)		•	•	•	•	•
Plastic	•	•		•	•	
Powder					•	
Printed circuit board		•		•		
Resistivity	•					
Rubber	•	•		•	•	
Solid	•	•		•	•	
Substrate	•	•		•	•	

Signal Source Device Test

Model	Frequency range	Brief description	Page
Signal source analyzer E5052B	10 MHz to 7/26.5/110 GHz	Single instrument solution provides a complete set of signal source measurements including phase noise, frequency, power, DC current, and frequency/phase/power transient	159

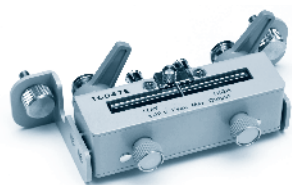

16047E

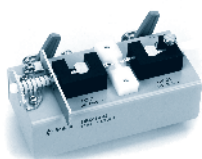

16034G

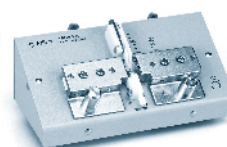

16044A



16089E



16196A/B/C/D

Test Accessories/Fixtures

			4263B	4285A	4287A	4294A	4294A with 42942A	4395A with 4395A-010 and 43961A	4396B with 4396B-010 and 43961A	E4980A	E4981A	E4991A
16034E	SMD/chip test fixtures	DC – 40 MHz	•	•		•				•	•	
16034G	SMD/chip test fixture, small	DC – 110 MHz	•	•		•				•	•	
16034H	SMD/chip test fixture, general	DC – 110 MHz	•	•		•				•	•	
16044A	SMD/Chip test fixture, kelvin contacts, 10 MHz	DC – 10 MHz	•	•		•				•	•	
16047A	Axial and radial test fixture	DC – 13 MHz	•	•		•				•	•	
16047D	Axial and radial test fixture	DC – 40 MHz	•	•		•				•	•	
16047E	Axial and radial test fixture, 110 MHz	DC – 110 MHz	•	•		•				•	•	
16048A	One meter test leads, BNC	DC – 30 MHz	•	•						•	•	
16048B	One meter test leads, SMC	DC – 30 MHz	•	•						•	•	
16048D	Two meter test leads, BNC	DC – 30 MHz	•	•						•	•	
16048E	Four meter test leads, BNC	DC – 2 MHz	•							•		
16048G	One meter test leads, BNC, 110 MHz	DC – 110 MHz				•						
16048H	Two meter test leads, BNC, 110 MHz	DC – 110 MHz				•						
16060A	Transformer test fixture	DC – 100 kHz	•									
16065A	Ext. voltage bias with safety cover (≤ 200 Vdc)	50 Hz – 2 MHz	•	•		•				•	•	
16065C	External bias adapter (≤ 40 Vdc)	50 Hz – 1 MHz	•									•
16085B	Four-terminal pair to 7-mm adapter	DC – 40 MHz	•	•						•	•	
16089A/B/C/D/E	Kelvin clip leads	5 Hz – 100 kHz	•	•		•				•	•	
16092A	RF spring clip: axial, radial and SMD	DC – 500 MHz	*1	*1	*4		•	•	•	*1	*1	•
16095A	LF impedance probe	DC – 13 MHz	*3	*3						*3	*3	
16192A	Parallel electrode SMD test fixture	DC – 2 GHz	*1	*1	*4		•	•	•	*1	*1	•
16194A	High temperature component test fixture	DC – 2 GHz	*1	*1	*4		•	•	•	*1	*1	•
16196A/B/C/D	Parallel electrode SMD test fixture	DC – 3 GHz	*1	*1	*4		•	•	•	*1	*1	•
16197A	Bottom electrode SMD test fixture	DC – 3 GHz	*1	*1	*4		•	•	•	*1	*1	•
16200B	External DC bias adapter	1 MHz – 1 GHz			*4		•	•	•			•
16316A	One terminal (BNC) balun (100 Ω bal. to 50 Ω unbal.)	100 Hz – 10 MHz						•	•			
16317A	One terminal (BNC) balun (600 Ω bal. to 50 Ω unbal.)	100 Hz – 3 MHz						•	•			
16334A	SMD/chip tweezers	DC – 15 MHz	•	•		•				•	•	
16451B	Dielectric material test fixture	5 Hz – 30 MHz	•	•		•				•	•	
16452A	Liquid test fixture	20 Hz – 30 MHz				•				•		
16453A	Dielectric material test fixture	1 MHz – 1 GHz										•
16454A	Dielectric material test fixture	1 kHz – 1 GHz					•					•
42842A/B	High bias current 20 A/40 A test fixture	20 Hz – 2 MHz								•		
42842C	High bias current 10 A test fixture	75 kHz – 30 MHz		•								
42941A	Impedance probe kit	DC – 110 MHz				•						
42942A	Four-terminal pair to 7-mm adapter	DC – 110 MHz				•						

Note : Refer to the accessory descriptions for frequency and operational limits

¹ Compatible when used in conjunction with 16085B

³ Do not connect the ground lead to the instrument

² 7-mm cable is required

⁴ 3.5-mm(m) to 7-mm adapter is required

4294A

- **Accurate measurement over wide impedance range and wide frequency range**
- **Basic impedance accuracy: $\pm 0.08\%$**
- **40 Hz to 110 MHz, 3 m Ω to 500 M Ω**
- **Powerful impedance analysis function**
- **Ease of use and versatile PC connectivity**
- **30% typical accuracy range: 3 m Ω (100 Hz to 110 MHz), 500 M Ω (100 Hz to 200 kHz)**

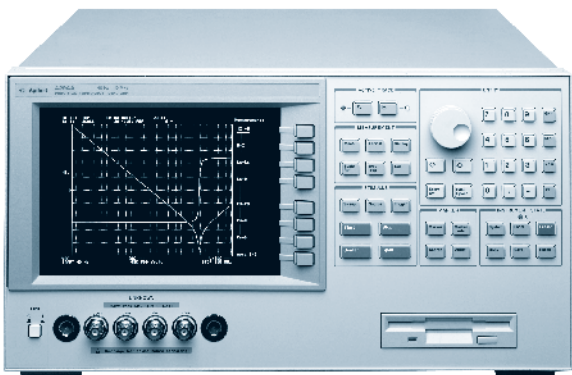

4294A

The Agilent 4294A precision impedance analyzer is an integrated solution for efficient impedance measurement and analysis of components and circuits. The 4294A covers a broader test-frequency range (40 Hz to 110 MHz) with basic impedance accuracy: $\pm 0.08\%$. Excellent High Q/Low D accuracy enables analysis of low-loss components. The wide signal-level ranges enable device evaluation under actual operating conditions. The test signal level range is 5 mV to 1 V_{rms} or 200 μ A to 20 mArms, and the DC bias range is 0 V to ± 40 V or 0 mA to ± 100 mA. Advanced calibration and error compensation functions eliminate measurement error factors when performing measurements on in-fixture devices. The 4294A is a powerful tool for design, qualification and quality control, and production testing of electronic components. Circuit designers and developers can also benefit from the performance/functionality offered.

The 4294A enables impedance measurement using the auto-balancing bridge technique over the frequency range 40 Hz to 110 MHz. The basic impedance accuracy is $\pm 0.08\%$, and the typical Q accuracy is $\pm 3\%$ @ Q = 100, ≤ 10 MHz. This advantage permits accurate evaluations of impedance characteristics for a wide variety of electronic devices as well as electronic and non-electronic material within a wide frequency range.

Specifications

Measurement parameters: |Z|, |Y|, θ , R, X, G, B, Cp, Cs, Lp, Ls, Rp, Rs, D, Q

Basic measurement accuracy

- Basic impedance accuracy (four-terminal-pair): $\pm 0.08\%$
- Basic impedance accuracy with 42941A: $\pm 0.8\%$ (typical)
- Basic impedance accuracy with 42942A: $\pm 0.6\%$

Source characteristic

- Test frequency: 40 Hz to 110 MHz
- Frequency resolution: 1 mHz
- Frequency accuracy: ± 20 ppm (± 0.13 ppm with 4294A-1D5)
- OSC level: 5 mV to 1 V_{rms}/200 μ A to 20 mArms
- OSC level resolution: 1 mV/20 μ A
- OSC level accuracy
- Voltage: $\pm((10 + 0.05 * f(\text{MHz}))\% + 1 \text{ mV})$ @ UNKNOWN Terminal OPEN
- Current: $\pm((10 + 0.3 * f(\text{MHz}))\% + 50 \mu\text{A})$ @ UNKNOWN Terminal SHORT
- Level monitor function: voltage, current

DC bias

- DC bias level: 0 to ± 40 V, 0 to ± 100 mA (auto level control function available)
- DC bias level resolution: 1 mV/40 μ A
- DC bias voltage accuracy: $\pm(0.1\% + (5 + 30 * I_{\text{mon}}(\text{mA})))$ mV
- DC bias current accuracy: $\pm(2\% + (0.2 * V_{\text{mon}}(\text{V})/20)$ mA
- DC level monitor function: voltage, current

Sweep characteristic

- Sweep parameter: frequency, AC voltage, AC current, DC bias voltage, DC bias current
- Sweep type: linear, log, list, zero span, manual, up/down
- Number of points: 2 to 801

Calibration/compensation/adapter type

- Calibration: open/short/load
- Compensation: open/short/load, port extension (electrical length)
- Adapter type: none, 1 m, 2 m, 7 mm adapter (42942A), probe (42941A)

Display

- Size: 8.4 inch
- Type: color LCD (TFT)

Analysis

- Marker: 8 markers, delta marker function, search function, analysis function
- Equivalent circuit function: approximation, simulation
- Others: IBASIC, limit line, accumulate mode

Interface

- LAN interface: 10 Base-T ethernet, RJ45 connector, TCP/IP
- Other interface: GPIB interface, printer (centronics), 8 bit I/O, 24 bit I/O, VGA monitor output

Storage

- Type: built-in 3.5 inch floppy disk drive, 10 Mbyte non-volatile memory, 512 kbyte volatile RAM disk memory

General specifications

- Operating temperature and humidity: 0 to 40 $^{\circ}$ C, 15 to 80% RH
- Power requirements: 90 to 132 V, or 198 to 264 V, 47 to 63 Hz, 300 VA maximum
- Size: 222 mm H x 426 mm W x 502 mm D (8.88 in x 17.04 in x 20.08 in)
- Weight: 25 kg (55 lb)

Ordering Information

4294A precision impedance analyzer

Furnished accessories: floppy disk, CD-ROM (manual), and power cable (no test fixture is supplied with the 4294A)

4294A-1D5 add high-stability frequency reference

4294A-800 standard frequency reference

4294A-810 add keyboard

42941A impedance probe kit

42942A 7 mm terminal adapter

Web Link

www.agilent.com/find/impedance

- Basic accuracy $\pm 0.8\%$
- 3 GHz impedance direct read-out
- Windows-styled user interface
- Sweep parameters (frequency, AC level, DC bias)
- Built-in VBA programming function
- Various test fixture for components
- Data transfer through the LAN interface
- Direct read-out permittivity, permeability (Option)
- Temperature characteristic measurement

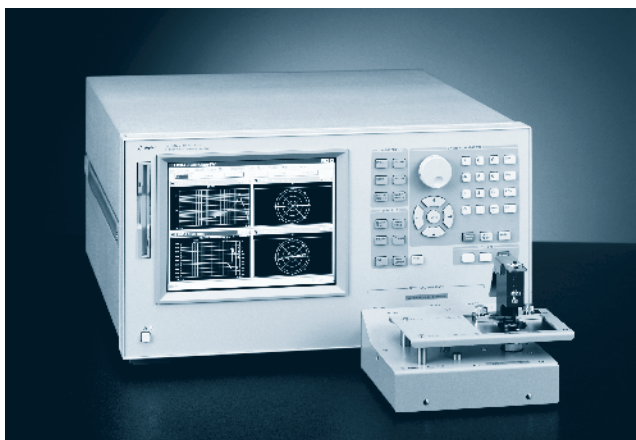

E4991A

The new Agilent E4991A RF impedance/material analyzer offers ultimate impedance measurement performance and powerful built-in analysis function. It will provide innovations in R&D of components and circuit designers who evaluate components in the range of 3 GHz. The E4991A uses an RF-IV technique, as opposed to the reflection measurement technique, for more accurate impedance measurement over wide impedance range. Basic impedance accuracy is $\pm 0.8\%$. High Q accuracy enables low-loss component analysis. The internal synthesizer sweeps frequency from 1 MHz to 3 GHz with 1 MHz resolution.

Material Evaluation

The E4991A provides the total dielectric/magnetic material measurement solutions in wide frequency range (1 MHz to 1 GHz).

Temperature Characteristic Test Solution is Ready

The E4991A provides a temperature characteristic measurement solution for components and materials. This solution provides highly accurate temperature characteristic analysis capability within the wide temperature range from -55 to $+150$ °C. The E4991A covers the wide impedance measurement range with a single test head. Also, the temperature drift compensation function enables you to perform open/short compensation at pre-defined temperature points so that temperature drift error can be drastically reduced.

Accurate Impedance Measurement with Probe Station

When connecting the E4991A to a probe station, accuracy degradation caused by port extension and improper calibration, is a significant concern. E4991A-010, probe station connection kit, provides all necessary parts in one option and solves this problem. This option includes extension cables, a connecting plate, and detailed installation procedures. Cascade Microtech is an Agilent channel partner and they provide RF probe stations. By combining E4991A-010 with a Cascade Microtech RF probe station, you can create an accurate on-wafer characterization system.

Specifications

- Measurement parameters: $|Z|$, θ_z , $|Y|$, θ_y , R, X, G, B, Cs, Cp, Ls, Lp, Rp, Rs, D, Q, $|\Gamma|$, θ_r , Γ_x , Γ_y
- Material parameters: $|\epsilon_r|$, ϵ_r' , ϵ_r'' , $|\mu_r|$, μ_r' , μ_r'' , $\tan\delta$
- Basic impedance accuracy: 0.8%
- Operating frequency: 1 MHz to 3 GHz, resolution: 1 mHz
- Frequency reference accuracy: $< \pm 10$ ppm @ 23 °C ± 5 °C
- Precision frequency reference: (E4991A Option 1D5)
- Accuracy: $< \pm 1$ ppm/year @ 0 to 55 °C, referenced to 23 °C

Source characteristics

- OSC level:
 - 4.47 mV to 477 mVrms
 - 89.4 μ A to 8.94 mArms
- Display level unit: V, I, dBm
- Level monitor function: voltage, current

DC bias (E4991A Option 001)

- DC level: 0 to ± 40 V, 0 to ± 50 mA
- DC level monitor function: voltage, current

Sweep characteristics

- Sweep parameter: frequency, AC signal level, DC bias level

Calibration/compensation

- Calibration: open/short/load/low-loss capacitor
- Compensation: open/short, port extension, fixture electrical length

Display

- CRT: 8.4-inch color LCD display

Storage

- Type: built-in 3.5-inch floppy disk drive, internal HDD

General specifications

- Operating temperature/humidity: 5 to 40 °C/20 to 80% RH
- Power requirements: 90 to 132 V, or 198 to 264 V, 47 to 66 Hz, 350 VA max.
- Size/weight:
 - Mainframe: 234 mm H x 426 mm W x 445 mm D (9.36 in x 17 in x 18.2 in)/17.0 kg (37.44 lb)
 - Test station: 64 mm H x 160 mm W x 160 mm D (2.56 in x 6.4 in x 6.4 in)/0.9 kg (1.98 lb)

Ordering Information

E4991A RF impedance/material analyzer

Furnished accessories: 16195B 7 mm coaxial calibration kit, floppy disk, CD-ROM (manual), and power cable (no test fixture is furnished with E4991A)

E4991A-001 add DC bias

E4991A-002 add material measurement firmware

E4991A-007 temperature characteristic test kit

E4991A-010 probe station connection kit

E4991A-800 standard frequency reference, no DC bias

E4991A-810 add keyboard

E4991A-820 add mouse

E4991A-1D5 high stability frequency reference

E4991A-ABA US-English localization

E4991A-ABJ Japan-Japanese localization

Web Link

www.agilent.com/find/impedance

4263B
E4980A

- 0.1% basic accuracy
- Test signal level monitor function
- High-speed measurement: 25 ms
- Wide capacitance test range
- Circuit protection against capacitor discharge (4 J)
- Transformer parameter measurements (optional)



4263B

4263B LCR Meter

The 4263B LCR meter is a cost-effective universal LCR Meter, designed for both production test and evaluating a variety of components.

Specifications

- Measurement parameters: $|Z|$, $|Y|$, θ , R, X, G, B, L, C, Q, D, ESR – 4263B Option 001: add DCR (DC resistance), N (turns ratio), and M (mutual inductance) measurement
- Test frequency: 100 Hz, 120 Hz, 1 kHz, 10 kHz, and 100 kHz – 4263B Option 002: add 20 kHz test frequency
- Test signal level: 20 mV to 1 Vrms in 5 mVrms steps
- Measurement accuracy: $\pm 0.1\%$ (basic) (for $|Z|$, R, X, $|Y|$, G, B, C, L)
- Test signal level monitor: voltage and current
- Measurement time: 25 ms/65 ms/500 ms (typical)
- Compensation function: open/short, open/short/load
- Cable length correction: 1/2/4 m
- Comparator function: high/in/low for each primary measurement parameter and secondary measurement parameter
- Contact check function: contact failure between the test fixture and device can be detected. Additional time for contact check: 5 ms
- Interface: handler, GPIB
- Power requirements: 90 to 132 V or 198 to 264 V, 47 to 66 Hz, 45 VA maximum
- Operating temperature: 0 to 45 °C
- Size: 100 mm H x 320 mm W x 300 mm D (3.94 in x 12.6 in x 11.81 in)
- Weight: 4.5 kg (9.9 lb)

Ordering Information

- 4263B LCR meter
- 4263B-001 add transformer parameter measurement function
 - 4263B-002 add 20 kHz test frequency
 - 4263B-ABA US-English localization
 - 4263B-ABJ Japan-Japanese localization

- 20 Hz to 2 MHz test frequency with 4-digit resolution
- 0.05% basic accuracy with superior meas. repeatability at low and high Z
- Open/short/load compensation and cable length correction (1/2/4 m)
- Fast measurement speed: 5.6 ms/meas.
- 20 Vrms/100 mArms test signal, ± 40 V DC bias, 2nd DC source (Option 001)
- 40 A DC bias current (Option 002) with 42841A
- List sweep measurement capability up to 201 points



E4980A

E4980A Precision LCR Meter

Agilent E4980A precision LCR meter sets a new standard of high-end LCR meters with its incomparable accuracy, speed, definable test signal level, and expandability. The advanced performance of the E4980A offers the best solutions and true versatility for a wide range of component and material measurement applications in general R&D and production environments.

Specifications

- Measurement parameters: Z, Y, θ , R, X, G, B, L, C, D, Q, ESR, (Rdc, Vdc, Idc, Option 001), deviation, % of deviation
- Measurement terminals: four-terminal pair
- Test frequency: 20 Hz to 2 MHz with 4-digit resolution
- Test signal level: 0 to 2 Vrms/0 to 20 mArms, 0 to up to 20 Vrms/0 to 100 mArms (Option 001)
- Test signal modes: normal, constant
- Basic measurement accuracy: 0.05%
- Compensation function: open/short, open/short/load
- Cable length correction: 1/2/4 m
- Integration time: short, medium, long
- DC bias: 0 to 2 V, ± 40 V/ ± 100 mA (Option 001)
- DC source: ± 10 V (Option 001)
- Interface: handler (Option 201), scanner (Option 301), GPIB, USB (host/interface), LAN
- Operating temperature/humidity: 0 to 55 °C, 15 to 85 % RH @ 40 °C
- Power requirements: 90 to 264 Vac, 47 to 63 Hz, 150 VA max.
- Size: 375 mm W x 105 mm H x 390 mm D (nominal)
- Weight: 5.3 kg (nominal)

Ordering Information

- E4980A precision LCR meter
- E4980A-001 power and DC bias enhancement
 - E4980A-002 bias current interface
 - E4980A-005 entry model
 - E4980A-201 handler interface
 - E4980A-301 scanner interface
 - E4980A-710 no interface
 - E4980A-ABA English manual
 - E4980A-ABJ Japanese manual
 - E4980A-1A7 ISO 17025 compliant calibration
 - E4980A-A6J ANSI Z540 compliant calibration
 - E4980A-1CM rackmount kit

Web Link

www.agilent.com/find/impedance

- 75 kHz to 30 MHz in 100 Hz steps
- 0.1% basic accuracy with 0.001 nH resolution
- Open/short/load compensation and cable length correction (1/2 m)
- ± 40 V DC bias (Option 001)
- 10 A DC bias current (Option 002) with 42841A
- List sweep measurement capability
- Handler, scanner interfaces (Option)



4285A

4285A Precision LCR Meter

Agilent 4285A precision LCR meter is cost-effective solution for component and material measurements. The 4285A offers a higher test frequency range, from 75 kHz to 30 MHz, with its incomparable accuracy, definable test signal level, and expandability for a wide range of component and material measurement applications in general R&D and production environments.

Specifications

- Measurement parameters: Z, Y, θ , R, X, G, B, L, C, D, Q, ESR, deviation, % of deviation
- Measurement terminals: four-terminal pair
- Test frequency: 75 kHz to 30 MHz with 100 Hz steps
- Test signal level: 5 mVrms to 2 Vrms/200 Ω Arms to 20 mArms (normal), 10 mVrms to 1 Vrms/100 Ω Arms to 20 mArms (constant)
- Test signal modes: normal, constant
- Basic measurement accuracy: 0.1 %
- Compensation function: open/short, open/short/load
- Cable length correction: 1/2 m
- Integration time: short, medium, long
- DC bias: ± 40 V (Option 001)
- Interface: handler (Option 201/202), scanner (Option 301), GPIB
- Operating temperature/humidity: 0 to 55 °C, ≤ 95 % RH @ 40 °C
- Power requirements: 100/120/220 Vac ± 10 %, 240 Vac 5 %/-10 %, 47 to 66 Hz, 200 VA maximum
- Size: 426 mm W x 177 mm H x 498 mm D
- Weight: 16 kg

Ordering Information

- 4285A precision LCR meter
- 4285A-001 DC bias
- 4285A-002 bias current interface
- 4285A-004 memory card
- 4285A-201 general purpose handler interface
- 4285A-202 specific handler interface
- 4285A-301 scanner interface
- 4285A-700 no DC bias
- 4285A-710 blank panel
- 4285A-ABA English manual
- 4285A-ABJ Japanese manual
- 4285A-1A7 ISO 17025 compliant calibration
- 4285A-A6J ANSI Z540 compliant calibration
- 4285A-908 rackmount kit

- 11 parameters: |Z|, |Y|, L, C, R, X, G, B, D, Q, θ
- Measurement range from 0.2 Ω to 3 k Ω (within 10% accuracy)
- 1% basic accuracy
- Measurement time: 9 msec per point (max. speed)
- Superior measurement repeatability at low test signal level with high speed
- Sophisticated calibration/compensation method with calibration wizard function

4285A
4287A

4287A

4287A RF LCR Meter 1 MHz to 3 GHz

The Agilent 4287A is a high performance RF LCR meter best fit to production line testing of devices such as SMD inductors and EMI filters, where impedance testing at high frequencies is required.

Specifications

- Measurement parameters: |Z|, |Y|, θ -z (deg/rad), θ -y (deg/rad), G, B, Ls, Lp, Cs, Cp, Rs, Rp, Q, D (four meas. parameters can be displayed at the same time)
- Test frequency: 1 MHz to 3 GHz
- Frequency resolution: 100 kHz
- Test signal
 - V: 4.47 to 502 mVrms @ $f \leq 1$ GHz, 4.47 to 447 mVrms @ $f > 1$ GHz
 - I: 0.0894 to 10 mArms @ $f \leq 1$ GHz, 0.0894 to 8.94 mArms @ $f > 1$ GHz
- Level monition function: voltage, current
- Basic Z accuracy: ± 1.0 %
- Measurement range: 200 m Ω to 3 k Ω (@ 1 MHz, accuracy ≤ 10 %)
- Measurement time: 9 msec per point (maximum speed)
- Rdc measurement: available for contact check
- Calibration: open/short/load/low loss capacitor
- Compensation: open/short, electrical length
- Mass storage function: 2 GB HDD
- Interface: GPIB, LAN (10 Base-T/100 Base-Tx automatic selection), handler interface
- Display: 8.4 inch color LCD display
- Operating temperature/humidity: 5 to 40 °C, 20 to 80% RH @ 40 °C
- Power requirements: 90 to 132 Vac or 198 to 264 Vac, 47 to 63 Hz, 350 VA maximum
- Size: 234 mm H x 425 mm W x 445 mm D (9.36 in x 17 in x 17.8 in)
- Weight: 16 kg/0.3 kg (35.2 lb/0.66 lb) (typical) (main frame/test head)

Ordering Information

- 4287A RF LCR meter
- Furnished accessories: test head (1 m), CD-ROM (manual), and power cable. (no test fixture is supplied with the 4287A)
- 4287A-004 add working standard set
- 4287A-020 add test fixture extension cable set
- 4287A-700 16195B calibration kit
- 4287A-710 test fixture stand
- 4287A-720 3.5 – 7 mm adapter
- 4287A-810 add keyboard
- 4287A-820 add mouse

Web Link

www.agilent.com/find/impedance

E4981A

- **Fast measurement speed – 2 ms (From trigger to EOM at 1 MHz)**
- **Accurate and repeatable measurements – basic accuracy capacitance: $\pm 0.07\%$**
- **9 bin sorting**
- **256 multi-channel correction**
- **Easy migration – compatibility with the 4268A and 4288A**



E4981A

E4981A Capacitance Meter

The E4981A 120 Hz/1 kHz/1 MHz capacitance meter offers a high-speed with reliable measurements for ceramic capacitor testing in the production lines. The E4981A realizes the measurement capabilities of capacitance from small to large values with accurate measurements. The E4981A contributes improvements of the test throughput, while attaining excellent component quality for ceramic capacitor testing.

Specifications

- Measurement parameters: Cs, Cp, D, Q, Rs, Rp, G
- Test frequency: 120 Hz, 1 kHz and 1 MHz (-2% , -1% , $+1\%$, $+2\%$ frequency shift available)
- Test signal level: 0.1 to 1 Vrms, $\pm 5\%$ in 0.01 Vrms steps
- Measurement range

Parameter	120 Hz	1 kHz	1 MHz
C	0 to 2 mF	0 to 200 Ω F	0 to 1.5 nF
D	0.000001 to 9.999999		

- Measurement time: 2.3 ms (1 MHz), 3.0 ms (1 kHz), 11.0 ms (120 Hz)
- Cable length compensation: 1 m, 2 m
- Comparator: 9 bin output to handler interface
- Scanner: 256 channels
- Interface: handler, scanner interface, GPIB, USB and LAN
- Operating temperature/humidity: 0 to 45 °C, $\leq 95\%$ RH @ 40 °C
- Power requirements: 90 to 264 VAC, 47 to 66 Hz, 150 VA maximum
- Size: 370 mm W x 105 mm H x 405 mm D (with handle and bumper)
- Weight: approximately 4.3 kg

Ordering Information

E4981A capacitance meter

Frequency option

E4981A-001 120 Hz/1 kHz/1 MHz

E4981A-002 120 Hz/1 kHz

Additional option

E4981A-ABA add hardcopy user's guide (English)

E4981A-ABJ add hardcopy user's guide (Japanese)

E4981A-1CM rackmounts kit

E4981A-600 delete front handle kit

E4981A-A6J ANSI Z540 compliant calibration

E4981A-1A7 ISO 17025 compliant calibration

Web Link

www.agilent.com/find/impedance

- 1 kHz AC measurement
- 0.4% basic accuracy for R
- Wide measurement range with high resolution (10 $\mu\Omega$ to 100 k Ω)
- High-speed measurement (34 ms)
- Selectable test signal current from 1 μA to 10 mArms
- Contact check function

- Wide measurement range: 1 k Ω to 16 P Ω (Peta: 10^{15})
- $\pm 0.6\%$ basic accuracy
- Stable test fixture: resistivity cell, component test fixture
- High-speed measurement: 10 ms
- Test sequence programming
- Built-in surface and volume resistivity calculation function
- Grounded and ungrounded (floating) DUT measurements

4338B
4339B



4338B

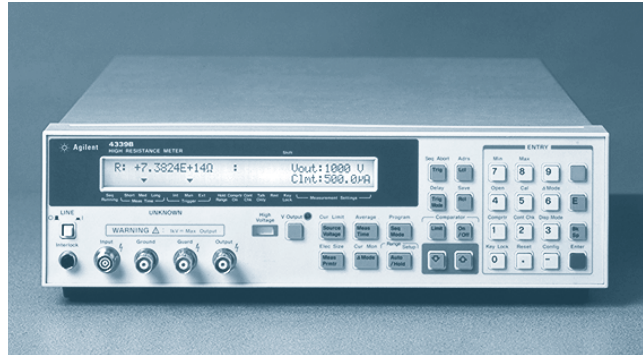

4339B

4338B Milliohmeter

Agilent 4338B milliohm meter is a precise, reliable, high-speed test tool for low resistance measurements of electromechanical components, batteries, cables, PC boards, etc. Agilent 4338B allows you to select low AC test signal levels (1 μA to 10 mA) suitable for your DUT.

Specifications

- Measurement parameters: R (ac resistance), X (reactance), L (inductance), |Z| (impedance), θ (phase [°])
- Combinations: R, R-X, R-L, |Z|- θ (series mode only)
- Test frequency: 1 kHz
- Test signal level: 1 μA , 10 μA , 100 μA , 1 mA, 10 mArms, maximum voltage across sample: 20 mV peak in any case
- Measurement accuracy: $\pm 0.4\%$ (basic) (for R)
- Measurement time: 34 ms/70 ms/900 ms (typical)
- Compensation function: zero short
- Comparator function: high/in/low for each primary measurement parameter and secondary measurement parameter
- Contact check function: contact failure between the test fixture and device can be detected
- Superimposed DC: ± 42 Vdc maximum may be present on measurement terminals
- Interface: handler, GPIB
- Power requirements: 90 to 132 V or 198 to 264 V, 47 to 66 Hz, 45 VA max.
- Operating temperature: 0 to 45 °C
- Size: 100 mm H x 320 mm W x 300 mm D (3.94 in x 12.6 in x 11.81 in)
- Weight: 4.5 kg (9.9 lb)

Ordering Information

4338B milliohmeter

Furnished Accessories: CD-ROM (manual), power cable (mating cable and test leads, or 16338A test lead kit, must be ordered separately)

4338B-ABA US-English localization

4338B-ABJ Japan-Japanese localization

4339B High-Resistance Meter

The 4339B high resistance meter is the most advanced tool for making precision high-resistance measurements.

Specifications

- Measurement parameters: R (DC resistance), I (DC current), ps (surface resistivity), pv (volume resistivity)
- Test voltage: 0.1 to 1000 Vdc, 0.1 V steps @ 0.1 to 200 V, 1 V steps @ 200 to 1000 V
- Maximum current: 10 mA @ ≤ 100 V, 5 mA @ ≤ 250 V, 2 mA @ ≤ 500 V, 1 mA @ ≤ 1 kV
- Current compliance setting: 0.5 mA, 1 mA, 2 mA, 5 mA, 10 mA
- Output resistance: 1 k Ω $\pm 10\%$
- Input resistance: 1 k Ω $\pm 10\%$
- Test cable lengths: 2 m maximum
- Measurement accuracy: $\pm 0.4\%$ (basic) (for I), $\pm 0.6\%$ (basic) (for R)
- Measurement time: 10 ms/30 ms/390 ms (typical)
- Compensation function: zero open
- Test sequence program: controls a series of resistance measurements. Charge time, measurement internal time, and measurement number can be programmed
- Comparator function: high/in/low for the measurement parameter
- Contact check function: contact failure between the test fixture and device can be detected.
- Interface: handler, GPIB
- Power requirements: 90 to 132 V or 198 to 264 V, 47 to 66 Hz, 45 VA max.
- Operating temperature: 0 to 45 °C
- Size: 100 mm H x 320 mm W x 450 mm D (3.94 in x 12.6 in x 17.72 in)
- Weight: 6.5 kg (14.3 lb)

Ordering Information

4339B high-resistance meter

4339B-ABA US-English localization

4339B-ABJ Japan-Japanese localization

Web Link

www.agilent.com/find/impedance

U1701B
U1731B
U1732B

- Maximum, minimum and average values recording
- Visible and audible tolerance mode for component sorting
- One-touch access to capacitance, inductance (U1700 Series LCD meters and resistance (U1700 Series LCR meters) measurements
- Guard terminal for better noise immunity (to be used with SMD tweezer)
- U1700 Series LCR meters: auto-calculation of phase angle (for U1732B), dissipation factor and quality factor
- U1700 Series LCR meters: wide LCR ranges with 2 to 4 selectable test frequencies
- Dual display with backlight (for U1701B and U1732B)



Efficient and Quick Component 1 Sorting

On the manufacturing floor, components may come in large batches for quick sorting to pre-defined specifications. Tolerance mode in the U1700 Series lets you zap through sorting of incoming capacitors, inductors or resistors to 1%, 5%, 10% or 20% tolerance of the specified reference value.

Additionally, compare mode in the U1701B capacitance meter allows easy memory save/recall of up to 25 high/low limit settings for convenient pass/fail screening of capacitors. This means speedier testing due to reduced set-up time and risk of manual input errors.

No Waiting for Quick, Basic LCR Tests

Sharing a bench LCR meter is practical, but isn't always convenient. With Agilent's line of handheld LCR meters, you can perform quick, basic LCR measurements at your convenience.

SMD Tweezer for Testing Surface-Mount Devices

The optional U1782A SMD tweezer enables easy testing of surface-mount devices. The tweezer comes with three shrouded banana plugs and an extended reach of 770 mm. The U1700 Series' guard terminal provides your measurements with better noise immunity and accurate readings.

Uncompromised Quality and Reliability

The U1731B and U1732B handheld LCR meters are housed in robust overmold and tested to stringent industrial standards. Each LCR meter is also sealed with a three-year warranty and the assurance that you can test your components with confidence.

Specifications

Agilent's range of handheld LCR meters

	U1701B	U1731B	U1732B
Display			
Dual display	Yes	Yes	Yes
Counts	11,000	20,000	20,000
Measurements			
Capacitance: range	0.1 pF to 199.99 mF	0.1 pF to 19.99 mF	0.1 pF to 19.99 mF
accuracy	Up to 0.5 % + 3 lsd	Up to 0.7 % + 3 lsd	Up to 0.7 % + 3 lsd
Inductance: range	—	0.1 μH to 999.9 H	0.1 μH to 999.9 H
accuracy	—	Up to 0.7 % + 5 lsd	Up to 0.7 % + 5 lsd
Resistance: range	—	0.001 Ω to 9.999 MΩ	0.001 Ω to 9.999 MΩ
accuracy	—	Up to 0.5 % + 3 lsd	Up to 0.5 % + 3 lsd
Dissipation factor (DF)	—	Yes	Yes
Quality factor (QF)	—	Yes	Yes
Phase angle measurement	—	—	Yes
Tolerance mode	1%, 5%, 10%, 20%	1%, 5%, 10%	1%, 5%, 10%, 20%
Compare mode	25 sets of non-volatile high/low limit settings	—	—
Test method/frequency	DC charge/discharge	Selectable 120 Hz/1 kHz	Selectable 100 Hz/120 Hz/1 kHz/10 kHz
Data Management			
Min/max/avg recording	Yes	Yes	Yes
Data hold	Yes	Yes	Yes
Data logging to PC (requires IR-to-USB cable U5481A for connection to PC)	IR-USB	IR-USB	IR-USB
General			
Operating temperature	0 to 50 °C	0 to 40 °C	0 to 40 °C
Battery	Alkaline 9 V AC power adapter and cord available as option	Alkaline 9 V AC power adapter and cord available as option	Alkaline 9 V AC power adapter and cord available as option

Ordering Information

U1701B handheld capacitance meter

U1731B handheld LCR meter

U1732B handheld LCR meter

Web Link

www.agilent.com/find/handheldlcr

- 10 MHz to 7 GHz RF test frequency range (up to 110 GHz with external down-converters and harmonic mixers)
- True single-connection to dramatically simplify signal source evaluations
- 1 Hz to 100 MHz phase noise analysis offset frequency range
- Easy one-step measurement with unparalleled phase noise sensitivity and exceptional measurement speed
- Complete set of transient measurements to fully characterize time response of hopping signal sources and PLL
- Independent AM and base-band noise measurement capabilities
- Built-in ultra-low-noise DC sources provide accuracy and flexibility on oscillator characterization
- Internal VBA programming for simple and easy automated measurements

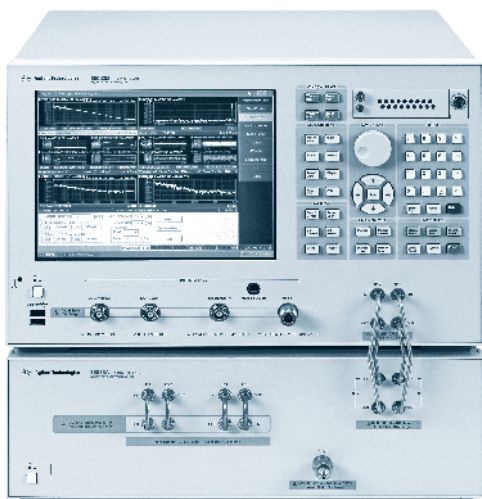

The E5052B signal source analyzer is a single-instrument solution that offers an indispensable set of measurement functions for evaluating RF & microwave signal sources such as VCOs, crystal oscillators, SAW oscillators, dielectric resonator oscillators, YIG oscillators, PLL synthesizers, RFICs, and LO circuits.

Applications include mmW signal source characterization with external mixers and precise clock jitter measurement for high-speed digital communication systems and components.

For phase noise, jitter or PM noise, AM noise, low frequency base-band noise measurements, the E5052B offers fast spectrum analysis at logarithmic frequencies up to 100 MHz maximum. Precise and detailed clock jitter analysis for high-speed data communication systems can be done, as well as for traditional low noise signal sources.

For frequency, power, and phase measurements, it has a complete set of test conditions both for statistic and transient characterization, as well as a spectrum monitoring function.

Superior measurement results are achieved by using built-in low-noise reference local oscillators and an innovative cross-correlation technique with two independent internal measurement channels. Thanks to built-in low-noise DC voltage sources the E5052B produces accurate and reliable VCO/PLL tests.

Offering extremely high sampling rate and fine frequency resolution in its transient measurements, which satisfy test needs of fast switching synthesizers for current and future wireless communications and aerospace & defense applications.

Specifications

Phase noise measurement

- Parameters
 - L(f) single-side-band (SSB) phase noise spectrum density
 - Residual PM or FM or RJ (random jitter) in user specified bandwidth
- RF input carrier frequency range
 - 10 MHz – 7 GHz (–26.5 GHz with the E5053A, 110 GHz with the 11970)
- RF input level
 - 20 to +20 dBm (–15 to +20 dBm @10 – 30 MHz)
- Offset frequency range
 - 1 Hz – 100 MHz (10 Hz – 100 MHz for Option 011)
- Residual noise floor: –178 dBc/Hz with built-in low noise reference LO's
- Enhanced phase noise sensitivity
 - "Cross-correlation method" can improve phase noise sensitivity up to 20 dB (except Option 011)
- Measurement speed
 - 0.3 sec per sweep @1 kHz – 100 MHz offset freq. range
 - 13 sec per sweep @1 Hz – 100 MHz offset freq. range

AM noise measurement

- RF input carrier frequency: 60 MHz – 7 GHz (–26.5 GHz with the E5053A)
- RF input level: –20 to +20 dBm
- Offset frequency range: 1 Hz to 40 MHz (10 Hz – 40 MHz for Option 011)

Base-band noise measurement

- Frequency range
 - 1 Hz – 100 MHz (AC coupled) [E5052B]
 - 10 Hz – 100 MHz (AC coupled) [E5052B Option 011]
- BNC 50 ohm input

Frequency, power, and DC current measurement

- Parameters: frequency, tuning sensitivity, frequency pushing, RF power level, DC power supply current
- Frequency resolution: 10 Hz/1 kHz/64 kHz
- RF power level uncertainty: 0.5 to 1 dB

Frequency, phase, RF power over time (transient) measurement

- Frequency transient measurement range
 - 4.8 GHz max. in wide-band mode (frequency only)
 - 3.125 kHz/25 kHz/200 kHz/1.6 MHz/25.6 MHz/80 MHz in narrow-band mode
- Frequency resolution: 0.0004 Hz min.*
- Time resolution: 8 nsec minimum*

* depending on frequency range and time span

Spectrum monitoring

- Frequency span: 15 MHz maximum
- Resolution bandwidth: 1.53 Hz – 400 kHz

DC sources

- DC control source: –15 to +35 V, 20 mA output maximum
- DC control source noise level: 1 nVrms/Hz @10 kHz typ.
- DC power supply source: 0 to +16 V, 80 mA output maximum
- DC power supply source noise level: 10 nVrms/Hz @10 kHz typ.

Front panel

10.4 inch color LCD (1,024 x 768 res.) display (touch screen)
Removable HDD, 2 USB connectors, Probe power connector (+15 V, –12.6 V, 150 mA maximum), GND terminal

Accessories

- E5053A** 3 to 26.5 GHz microwave downconverter
- E5001A SSA-J** precision clock jitter analysis software
- U1818A/B** active differential probe, 100 kHz to 7/12 GHz
- 11970** Series harmonic mixers

Ordering Information

- E5052B** 10 MHz to 7 GHz signal source analyzer
 - E5052B-011** delete functions
- E5053A** 3 GHz to 26.5 GHz microwave downconverter
- E5001A-1FP** E5001A jitter application – standard tier, fixed, perpetual license

Web Link

www.agilent.com/find/ssa

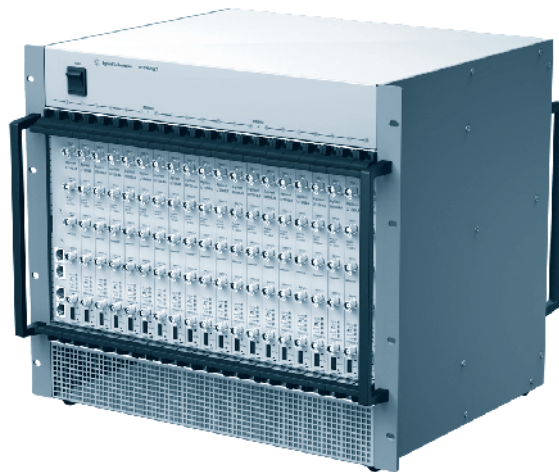

80 channel high-speed digitizer system integrated into a 19" rack chassis

The Agilent Acqiris product line provides a range of time-to-digital converters (TDC) as well as 500 MS/s, 1 GS/s, 2 GS/s, 4 GS/s and 8 GS/s high-speed digitizer cards with 8-, 10- and 12-bit resolution, wide bandwidths and large acquisition memories. These products, in PCI, PCI Express (PCIe), CompactPCI (cPCI), and VME formats, are used as data acquisition components in research systems and automated test equipment, and embedded as OEM components in to systems used in industries as widespread as biotechnology, semiconductors, aerospace, physics, and astronomy.

In laboratories around the world, Agilent cPCI instrumentation has become an integral part of advanced experimental systems, whether for system control or experiment observation.

cPCI digitizers and TDC's provide channel density that is designed for use in multichannel systems. By integrating multiple units into one desktop or rackmount chassis it is possible to create a complete data acquisition system with up to 80 synchronized digitizer acquisition channels or 240 TDC channels in one chassis.

Multichannel systems containing Agilent acqiris digitizers or TDC's can be easily controlled using the turnkey multichannel acquisition software AcqirisMAQS. This powerful PC oscilloscope software was designed and developed specifically for control and monitoring of advanced data acquisition systems with many channels, and is ideal for single-shot/event applications in hydrodynamics, particle and nuclear physics. It allows remote Ethernet operation of multiple systems at various networked locations.

3

	Standard	Resolution	Channels	Bandwidth	Max sample rate	Notes
U1066A-001	cPCI	12-bit	2 ch	100/300 MHz	420 MS/s	Digitizer, 8 MS max. acquisition memory
U1066A-002	cPCI	12-bit	2 ch	100 MHz	200 MS/s	Digitizer, 8 MS max. acquisition memory
U1065A-001	cPCI/PXI	10-bit	1 ch	2 – 3 GHz	8 GS/s	Digitizer, 1024 MS max. acquisition memory
U1065A-002	cPCI/PXI	10-bit	2 ch	2 – 3 GHz	4 – 8 GS/s	Digitizer, 512 – 1024 MS max. acquisition memory
U1065A-004	cPCI/PXI	10-bit	4 ch	1 – 2 GHz	2 – 8 GS/s	Digitizer, 256 – 1024 MS max. acquisition memory
U1064A-001	cPCI	8-bit	1 ch	1 GHz	4 GS/s	Digitizer, 32 MS max. acquisition memory
U1064A-002	cPCI	8-bit	2 ch	1 GHz	2 – 4 GS/s	Digitizer, 16 – 32 MS max. acquisition memory
U1064A-004	cPCI	8-bit	4 ch	1 GHz	1 – 4 GS/s	Digitizer, 8 – 32 MS max. acquisition memory
U1063A-001	cPCI	8-bit	4 ch	2 GHz	500 MS/s (2 GS/s interleaved)	Digitizer, 2 MS max. acquisition memory
U1063A-002	cPCI	8-bit	8 ch	300 MHz	125 MS/s	Digitizer, 8 MS max. acquisition memory
U1080A-001	cPCI	8-bit	2 ch	1 GHz	1 – 2 GS/s	Digitizer with on-board FPGA processing
U1080A-002	cPCI	8-bit	2 ch	1 GHz	1 – 2 GS/s	Digitizer with on-board FPGA processing and optical data streaming
U1050A-001	cPCI	50 psec	12 ch	—	—	Single-hit time to digital converter
U1050A-002	cPCI	5 psec	12 ch	—	—	Single-hit time to digital converter
U1051A	cPCI	50 psec	6 ch	—	—	Multi-hit time to digital converter

Web Link

www.agilent.com/find/embedded-digitizers

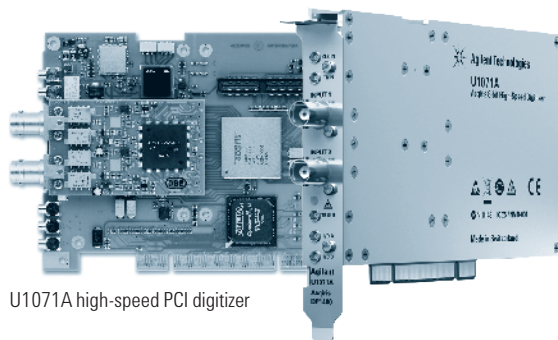

U1071A high-speed PCI digitizer

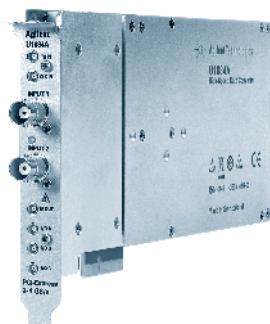

U1084A high-speed PCIe digitizer with on-board processing

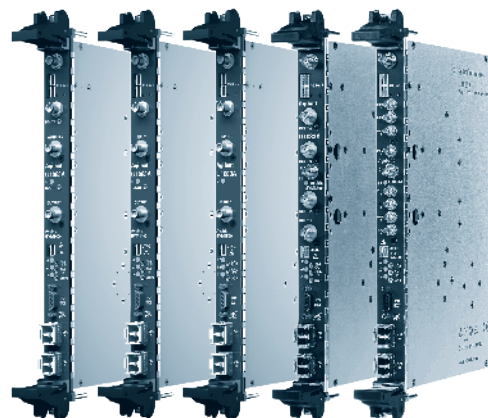

U1083A high-speed VME/VXS digitizers and generators with on-board processing

The Agilent Acqiris product line provides a range of time-to-digital converters (TDC) as well as 500 MS/s, 1 GS/s, 2 GS/s, 4 GS/s and 8 GS/s high-speed digitizer cards with 8-, 10- and 12-bit resolution, wide bandwidths and large acquisition memories. These products, in PCI, PCI Express (PCIe), CompactPCI (cPCI), and VME formats, are used as data acquisition components in research systems and automated test equipment, and embedded as OEM components in to systems used in industries as widespread as Biotechnology, Semiconductors, Aerospace, Physics, and Astronomy.

If you plan to design-in high speed data converters as OEM components into your own products that are sold to end-users in your target markets, Agilent not only provides you the right products and software, but also the sales, service and support process you need.

PCI, PCIe and VME digitizers provide powerful Agilent digitizing performance that can be scaled to meet the needs of your product. These digitizers are easily integrated, being based around standard form factors and supplied with drivers that support a range of development environments. These digitizers

can provide real-time data processing, to increase measurement throughput, with on-board field programmable gate arrays (FPGA) and off the shelf firmware. Alternatively custom firmware can be developed for any given application using a firmware development kit, allowing the implementation of user defined algorithms and processes.

3

	Standard	Resolution	Channels	Bandwidth	Max sample rate	Notes
U1070A-001	PCI	12-bit	1 ch	100/300 MHz	420 MS/s	Digitizer, 4 MS max. acquisition memory
U1070A-002	PCI	12-bit	1 ch	100 MHz	200 MS/s	Digitizer, 4 MS max. acquisition memory
U1070A-003	PCI	12-bit	1 ch	50 MHz	100 MS/s	Digitizer, 4 MS max. acquisition memory
U1071A-001	PCI	8-bit	2 ch	1 GHz	1 – 2 GS/s	Digitizer, 128 – 256 MS max. acquisition memory
U1071A-002	PCI	8-bit	2 ch	500 MHz	1 – 2 GS/s	Digitizer, 128 – 256 MS max. acquisition memory
U1071A-003	PCI	8-bit	2 ch	150 MHz	0.5 – 1 GS/s	Digitizer, 128 – 256 MS max. acquisition memory
U1084A-001	PCIe	8-bit	2 ch	1.5 GHz	2 – 4 GS/s	Digitizer with on-board FPGA and 512 MB processing memory
U1083A-001	VME/VXS	14-bit	2 ch	500 MHz	1.2 GS/s	Generator with onboard FPGA
U1083A-002	VME/VXS	10-bit	2 ch	3 GHz	2 GS/s	Digitizer with onboard FPGA
U1083A-003	VME/VXS	10-/14-bit	2 ch	3 GHz/500 MHz	1.2 GS/s	Digitizer/generator with onboard FPGA
U1083A-005	VME/VXS	12-bit	4 ch	2 GHz	500 MS/s (2 GS/s interleaved)	Digitizer with onboard FPGA
U1083A-007	VME/VXS	14-bit	8 ch	300 MHz	125 MS/s	Digitizer with onboard FPGA

Web Link

www.agilent.com/find/embedded-digitizers

M9210A
M9211A

- Dual-channel 10-bit digitizing scope with up to 4 GS/s sampling rate
- Up to 1.4 GHz bandwidth in 50 Ω, 300 MHz in 1 MΩ
- DC or AC-coupled
- Large acquisition memory up to 256 Mpoints/channel
- Multi-module synchronization with auto-synchronous bus system
- Software support for easy integration

- Single-channel 10-bit IF digitizer with 3 GHz bandwidth
- Up to 4 GS/s sampling rate
- DC coupled with internal DC calibration
- Large acquisition memory of up to 512 Mpoints
- Multi-module synchronization with auto-synchronous bus system
- Software support for easy integration



M9210A PXI-H digitizing scope



M9211A PXI-H wideband IF digitizer

3

M9210A PXI-H 10-bit Digitizing Scope

The M9210A is a one-slot 3U PXI-Hybrid high-speed digitizing scope featuring 2 50 Ω/1 MΩ channels with 1.4 GHz/300 MHz analog bandwidth and up to 4 GS/s real-time sampling rate, significantly reducing data acquisition and testing times. The M9210A digitizing scope comes with on-board memory of up to 512 MB. Ideal for high-speed applications such as telecommunications, ATE, and semiconductor testing, the M9210A is the best successor to the Agilent VXI E1428.

Ordering Information

M9210A PXI-H high-speed digitizer scope: 10-bit, 2 – 4 GS/s, 1.4 GHz
M9210A-M06 memory, 64 Msample acquisition
M9210A-M51 memory, 512 Msample acquisition

Accessories

U1093A-AS5 AS bus 2 connector
M9210A-UK6 calibration certificate and cal data
R1280A warranty

Web Link

www.agilent.com/find/m9210a

M9211A PXI-H 10-bit UWB IF Digitizer

The M9211A is a one-slot 3U PXI-Hybrid single-channel Ultra-wideband IF digitizer able to capture signals at up to 3 GHz and running at up to 4 GS/s, significantly reducing data acquisition and testing times. The M9211A UWB IF digitizer comes with on-board memory of up to 512 MBytes. Ideal for very high frequency signal capture in applications such as A&D, telecommunications, ATE, and semiconductor testing. The M9211A is also a lower-cost alternative to the M9202A 12-bit IF Digitizer.

Ordering Information

M9211A PXI-H high-speed wideband IF digitizer: 10-bit, 4 GS/s, 3 GHz
M9211A-M06 memory, 64 Msample acquisition
M9211A-M51 memory, 512 Msample acquisition

Accessories

U1093A-AS5 AS bus 2 connector
M9211A-UK6 calibration certificate and cal data
R1280A warranty

Web Link

www.agilent.com/find/m9211a

- Up to 2 GS/s sampling rate
- 1 GHz bandwidth
- 12-bit resolution
- 512 MB DDR3 memory
- Virtex-6 FPGA with implemented digital down-conversion algorithm
- PXIe x4 backplane interface
- Software support for easy integration



M9202A high-speed PXIe IF digitizer

M9202A PXI Express 12-bit Wideband IF Digitizer

The M9202A is a one-slot 3U PXIe wideband IF digitizer running at 2 GS/s, with up to 1 GHz instantaneous analog bandwidth. The M9202A features on-board signal processing capability and a large DDR3 memory.

The sampling rate of this IF digitizer, in combination with its wide input bandwidth and high dynamic range, make it ideal for aerospace/defense and wireless communication industries, especially in applications such as Military mobile repair stations, radar test, wideband communication standard test and fast signal capture application.

The M9202A incorporates a digital down-conversion (DDC) algorithm implemented in a Xilinx Virtex-6 FPGA that allows signal-to-noise ratio (SNR) improvement and data upload time reduction.

The PXI Express back-plane connection implements a PCIe Generation 1 x4 (four lanes) protocol allowing maximum theoretical digitized data throughput of 1 GB/s. The transfer rate will double when upgrading the hardware to a PCIe Generation 2 protocol when this becomes available, reaching 2 GB/s maximum theoretical data throughput.

The M9202A wideband IF digitizer is particularly useful when bundled with partner products, the M9361A PXI uW downconverter and the M9302A PXI local oscillator. Combined with the 89600 VSA measurement software, these combined elements provide a full PXI modular uW vector signal analyzer solution.

For easy integration, the digitizer comes with IVI-COM, IVI-C and LabView drivers for Windows XP, Windows Vista® (32/64-bit), Windows 7 (32/64-bit) operating systems (OS). In addition it supports VisualStudio.NET (C/C++, C#, VB.NET), LabVIEW, LabWindows/CVI, MATLAB and VEE application development environments (ADE).

Ordering Information

M9202A PXIe IF digitizer: 12-bit, 2 GS/s, 1 GHz
M9202A-C01 Single-channel
M9202A-F02 frequency range, 2 GS/s
M9202A-M05 standard memory, 512 MB
M9202A-DDC digital downconversion firmware

Accessories

M9392A-CD1 software and product information on CD
M9202A-KIT kit – shipping
M9211A-UK6 calibration certificate and cal data
R1280A warranty

Web Link

www.agilent.com/find/m9202a

M9202A

L4532A
L4534A

- 20 MSa/s, 16-bit ADC simultaneous sampling
- ± 250 mV to ± 250 V isolated inputs
- AC or DC coupling
- Standard 32 MSa/ch or extended 128 MSa/ch memory
- On-board measurements
- Built-in web interface, for control without programming
- Gigabit LAN & USB 2.0 interfaces, LXI C compliant



L4534A 20 MSa/sec digitizer

The Agilent Technologies L4532A and L4534A are high resolution, standalone LXI digitizers. They offer 2 or 4 channels of simultaneous sampling at up to 20 MSa/s, with 16 bits of resolution. Inputs are isolated and can measure up to ± 250 V to handle your most demanding applications.

Input channels with the ability to measure waveforms up to 250 V are beneficial when analyzing high voltage and transient signals as seen in many automotive and aerospace defense applications. For example, since the ± 250 V input range is combined with 16 bit analog to digital converters (ADCs), isolated front-end and low input offset allows a small voltage, such as a 250 mV, and a larger voltage, such as 250 V, to be measured in the same capture.

The digitizers are LXI Class C compliant providing the benefits of an Ethernet connection, standard software drivers an enhanced web interface, and more. Multiple vendors support the LXI standard making it easy to integrate the digitizers into your test system.

Save Test Time and Money with High Performance Analog Inputs

The digitizer's individually isolated channel inputs have been designed for high performance with an A/D converter per channel to ensure the signals you measure are accurately digitized without distortion or additional noise. Channel input range is configurable from ± 250 mV up to ± 250 V with a floating voltage up to ± 40 V to accommodate differential waveform acquisition. You can also choose to enable 2 MHz and 200 KHz input filters to your digitizer. The high voltage input, isolated inputs and selection of noise filters reduces the need to add expensive input signal attenuation and signal conditioning circuitry, saving test development time and money.

The 16 bit dynamic range combined with the ± 250 V range is an advantage for test throughput since there is no need to make repeated "passes" with different range settings to capture both the smaller waveform details and the larger waveform signals.

Minimize Post Processing with Onboard Measurements

The L4532A and L4534A digitizers include a collection of on-board "scope-like" measurements such as Vmin/Vmax, Vp-p, frequency, rise/fall time, and more that can be applied to a selected portion or the overall waveform. There is no need for post processing data to get the measurement results you need, saving time and minimizing the need to transfer and store large amounts of data. The waveform measurements are made within a user selected region of the digitized waveform and include their time position. The following measurements are supported by the digitizers.

- V min/V max
- VPP
- V avg/V rms
- V top/V base
- Rise/fall time
- Overshoot/preshoot
- Frequency/period
- Pulse width
- Duty cycle

Easy-to-Use Graphical Web Interface

Configure, acquire and display waveforms and measurements without programming. It's easy to connect to the digitizers' graphical web interface either by direct LAN or through the Internet with your PC's Java™-enabled web browser (i.e. Internet Explorer). Enter the digitizer's displayed IP address into the web browser and you are ready to set up and acquire waveform data.

The web interface simultaneously displays the channel signals and measurements, and provides an instrument command log that is very useful during development or debug. The digitizer's web interface is easy to use, even from remote locations. Use the setup digitizer window to set the digitizers' configuration including sample rate, voltage range, record size, trigger source, trigger mode, and more. Click on the acquire data window to display the waveforms and measurements. The waveform display has a similar look and feel to an oscilloscope with adjustable vertical and horizontal views. Select a portion of a waveform using the markers to make measurements on or view the waveform more closely. The web interface records and displays the digitizers' instrument commands you select in the setup window. The list of instrument commands can be copied and pasted directly into your test program to expedite your test development.

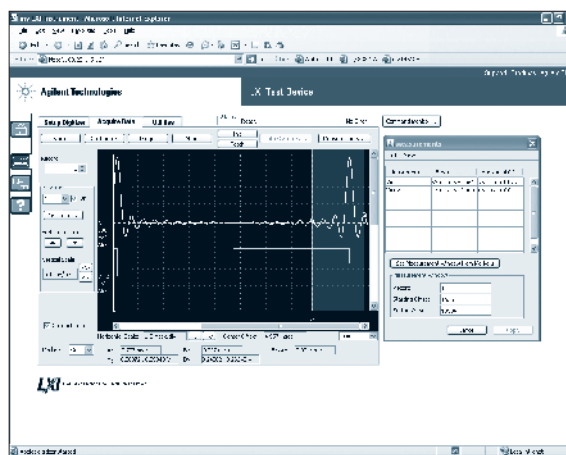

L4534A web interface

Deep Memory for Flexible Data Acquisition

The L4532A and L4534A digitizers include a deep memory option (up to 128 MSa per channel) allowing you flexibility in the way you acquire waveform data. The waveform data collected is determined by the user and the digitizer's configuration including sample rate, segmented memory, flexible trigger system, and data reduction feature for data transferred from memory.

Segmented memory is used for sampling multiple bursts of readings. Memory can be segmented in 1 to 1024 records. Multiple records allow multiple bursts of data to be digitized without the need to re-initialize between bursts. The record size is configured by selecting the total number of samples including pre-trigger samples.

A flexible trigger system enables capturing only the data that is needed. Trigger events are used to initialize the digitization of data for each record. Configurable trigger delay and trigger holdoff allow you to better define where record data is collected relative to the trigger event.

When retrieving digitized data users can take advantage of the built-in data reduction feature. This allows you to reduce the amount of unnecessary data through data decimation on select channels that were sampled at a faster rate than necessary.

Abridged Specifications

L4532A (2 channel) or L4534A (4 channel) digitizers with ADCs per channel.

- Max sample rate: 20 MSa/s
- Sample resolution: 16 Bits
- Input configuration: isolated inputs (each channel independently isolated)
- Isolation voltage (low to chassis): ± 40 V
- Maximum input (Hi to Low): ± 250 Vpk
- Maximum input range: ± 256 V
- Input impedance: 1 M Ω || 40 pF
- Input coupling: DC or AC
- AC cutoff freq (-3 dB): < 10 Hz
- Input ranges: ± 256 V, ± 128 V, ± 64 V, ± 32 V, ± 16 V, ± 8 V, ± 4 V, ± 2 V, ± 1 V, ± 500 mV, ± 250 mV
- Over voltage protection: yes
- Maximum overvoltage transient: ± 400 Vpk
- Analog bandwidth (-3 dB): 20 MHz typical
- Noise filtering (2-pole Bessel): 200 KHz, 2 MHz typical

Sampling

Programmable sample rates:

1 KSa/s, 2 KSa/s, 5 KSa/s, 10 KSa/s, 20 KSa/s, 50 KSa/s, 100 KSa/s, 200 KSa/s, 500 KSa/s, 1 MSa/s, 2 MSa/s, 5 MSa/s, 10 MSa/s, 20 MSa/s.

Accuracy¹

DC Accuracy

Total specification (% of reading + % of range).

Range	23 °C \pm 5 °C		Tautozero ± 3 °C	Temp coefficient outside 18 – 28 °C	
	\pm % of reading	\pm % of range	\pm % of range	\pm % of reading/C	\pm % of range/C
250 mV	0.10	0.30	0.11	0.010	0.015
500 mV	0.10	0.20	0.06	0.010	0.010
1 V, 2 V	0.10	0.12	0.04	0.010	0.010
4 V, 64 V	0.10	0.30	0.05	0.010	0.015
8 V, 128 V	0.10	0.20	0.04	0.010	0.010
16 V, 32 V, 256 V	0.10	0.12	0.04	0.010	0.010

- Integral nonlinearity: ± 5 LSB
- Differential nonlinearity: ± 1 LSB typical, no missing codes
- Input bias current: < 10 nA typical

Dynamic Characteristics³ (Measured using a 65536 point FFT)

		SFDR – dBc	THD – dBc	SNR – dB	SINAD – dB	ENOB ²
Input range 980 kHz input (–1 dBFS)	250 mV	71	79	67	66.7	10.8
	500 mV	77	83	70	69.8	11.3
	1 V	81	85	73	72.7	11.8
	2 V	85	82	75	74.2	12.0
	4 V	70	80	64	63.9	10.3
	8 V	70	83	65	64.9	10.5
	16 V	70	81	65	64.9	10.5
Input range 10 MHz input (–1 dBFS)	250 mV	71	71	66	64.8	10.5
	500 mV	71	73	68	66.8	10.8
	1 V	69	68	72	66.5	10.8
	2 V	63	62	72	61.6	9.9

¹ 100,000 reading average @ 1 MSa/s

For 1 V range and greater, typical offset with constant temperature is 0.01% of range

² ENOB = (SINAD – 1.76)/6.02

³ External timebase measurements made with 1 Vpp sinewave with < 2 ps RMS jitter

Data storage/transfer

- Pre trigger data: up to full record length -4 samples
- Record length: 8 samples to 32 MSa/128 MSa
- Post trigger data: 4 samples to 128 MSamples
- Maximum # of triggers: number of records (triggers) configurable to 1024 records
- Resolution: one sampling interval
- Timestamp rollover: > 1.5 years
- Maximum data transfer rate from memory:
 - USB 2.0: 8 MB/s
 - Gbit LAN: 15.0 MB/s

Ordering Information

L4532A 2 channel 20 MSa/s digitizer

L4532A-001 standard memory (32 MS/ch)

L4532A-002 extended memory (128 MS/ch)

L4534A 4 channel 20 MSa/s digitizer

L4534A-001 standard memory (32 MS/ch)

L4534A-002 extended memory (128 MS/ch)

Both instruments include a product reference CD (products doc and examples), IO libraries CD, and power cord.

Accessories

Opt 908 rack mount kit L4532-67001

Web Link

www.agilent.com/find/digitizers

35670A

- 122 μ Hz to 102.4 kHz
- Two or four channels (optional)
- 1600 line frequency resolution
- 16-bit ADC/90 dB dynamic range (typical)
- 16 MB RAM standard
- Integrated source

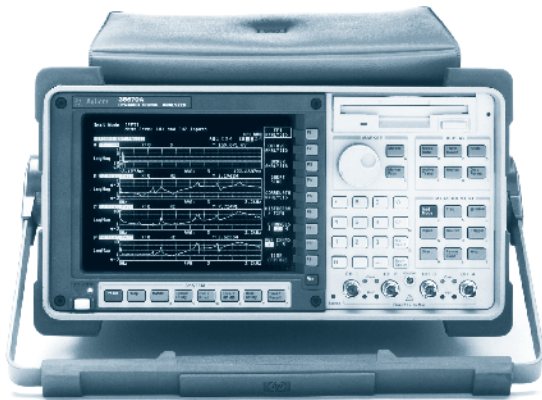

35670A

35670A Dynamic Signal Analyzer

The 35670A lets you make laboratory-quality measurements in the field, on an automobile test track, flying above a city, or in the narrow confines of a submarine. Small enough to fit under an airplane seat, the 35670A is a two-, or four-channel (35670A Option AY6), FFT-based spectrum/network analyzer. The standard instrument provides spectrum, network, time-domain, and amplitude-domain measurements from virtually DC to slightly over 100 kHz. Your ability to solve problems in the field is enhanced with the optional four-channel 35670A – measure noise at multiple locations inside vehicles, make triaxial vibration measurements, or gather data from several locations along a noise transmission path.

With the 35670A, you carry all your measurement and analysis tools in one package. Octave analysis (35670A Option 1D1) adds real-time measurements of 1/1, 1/3, or 1/12 octave spectra at frequencies up to 40 kHz. Computed order tracking (35670A Option 1D0) allows you to view spectra as a function of orders, or to view the amplitude of multiple orders as a function of RPM. Standard 16 MB of memory provides deep transient time capture or extra space for 2 MB of non-volatile memory. An arbitrary source (35670A Option 1D4) lets you test devices with real-life test signals. With Instrument BASIC (35670A Option IC2), you can automate measurements or customize your instrument interface. Everything you need to troubleshoot vibration and noise problems in the field is in one instrument. (You can retrofit all options – buy only the functionality you need today and add more as your needs change.)

A deep transient time capture memory can record up to four channels of data plus a tachometer signal for playback in the narrowband FFT, octave, order, correlation, or histogram instrument modes. Pre- and post-trigger delay functions let you capture the leading edge of one-time events or eliminate transmission delay in signals.

Real-Time Octave Analysis to 40 kHz (ANSI S1.11-1986)

Octave analysis (35670A Option 1D1) adds a real-time octave analyzer to your 35670A for analysis in 1/1-, 1/3-, or 1/12-octave bands. Four LEMO connectors with power for microphones are provided by the microphone adapter and power supply (35670A Option UK4). The 1/1- and 1/3-octave band filters in the 35670A comply fully with ANSI S1.11-1986 (Order 3 Type 1-D), DIN 45651, and IEC 225-1966. An overall total power band and an A-weighted overall power band can be activated as needed. All three octave band modes and the overall power band can be A-weighted with an analog filter in full compliance with IEC 651-1979 Type 0. The overall power band can be redefined as a broadband impulse detector that complies with IEC 651-1979 Type 0. A fan-off mode eliminates instrument noise from measurements. A pink noise source allows you to evaluate electro-acoustic devices.

View Spectra in the Order Domain (35670A Option 1D0)

View spectra as a function of orders or track up to five orders on four channels simultaneously with computed order tracking (35670A Option 1D0). Orders as high as 200 can be tracked. An order map can be displayed as a function of RPM or time, using the waterfall function. Waterfall markers let you view the track of any order.

Computed order tracking is ideal for troubleshooting rotating machinery. Run-up or run-down measurements can be displayed in bode or polar formats. Oscilloscope-quality orbit diagrams are another benefit. Because the data is resampled with changes in RPM, a single-loop orbit display is maintained as the shaft RPM is varied. With four channels (35670A Option AY6), two orbits can be measured simultaneously—at both ends of a shaft, for instance. An RPM measurement readout, available in any instrument mode, aids in the interpretation of measurement data from rotating machinery.

Computed order tracking provides alias-protected measurements without expensive and cumbersome external ratio synthesizers and tracking filters. This new technique uses a digital tracking algorithm that follows rapid changes in shaft RPM without time delay and eliminates the phase noise normally associated with ratio synthesizer techniques. Accuracy is enhanced over traditional methods.

Swept-Sine or Broad Measurement Range (35670A Option 1D2)

The swept-sine instrument mode expands the network analysis range of the 35670A to 130 dB. Higher noise rejection and accuracy are obtained by auto-ranging the instrument during the sweep. Automatic sweep resolution reduces measurement time without sacrificing accuracy. Alternatively, sweep resolution can be set by the user.

Advanced Modeling and Analysis Cut Design Time

Prototype revisions are reduced by modeling design modifications using curve fit and synthesis functions (35670A Option 1D3). In a typical application, a model of the test device is created by curve fitting a frequency response measurement. Up to 20 poles and 20 zeros are used to describe the device; results can be output in pole/zero, pole/residue, or polynomial formats. The designer then transfers the circuit model to the synthesis function. Using synthesis, the model is modified by adding or deleting poles and zeros. The frequency response function of the modified model is then synthesized to test the design modification.

DataLink Data Transfer Solution (35670A Option 1G0)

This no charge option gives you everything you need to transfer data files from your 35670A through a USB port at your personal computer. Data files saved on the 35670A RAM, non-volatile RAM or floppy drive may be transferred using the DataLink solution. In addition to the DataLink software, the option comes standard with the 82357B GP-IB to USB converter.

Ordering Information

- 35670A dynamic signal analyzer
- 35670A-AY6 add 2 input channels
- 35670A-1D0 computed order tracking measurements
- 35670A-1D1 real-time octave measurements
- 35670A-UK4 microphone adapter and power supply
- 35670A-1D2 swept-sine measurements
- 35670A-1D3 curve fit/synthesis
- 35670A-1D4 arbitrary waveform source
- 35670A-1C2 instrument BASIC
- 35670A-100 software bundle
- 35670A-1G0 datalink GP-IB to USB solution

Web Link

www.agilent.com/find/35670A

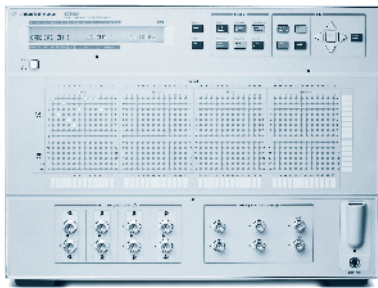

B220xA low leakage switching matrices

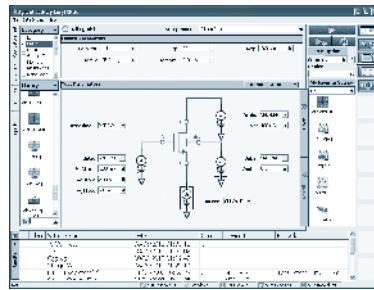

EasyEXPERT software Series



E526xA/E5270B modular SMU Series

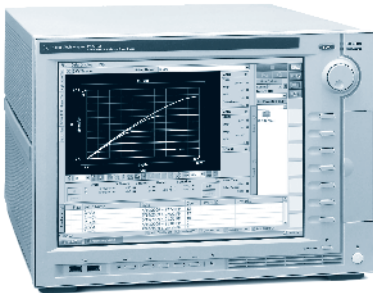

B1505A power device analyzer/curve tracer

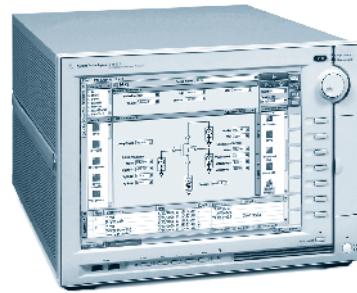

B1500A semiconductor device analyzer

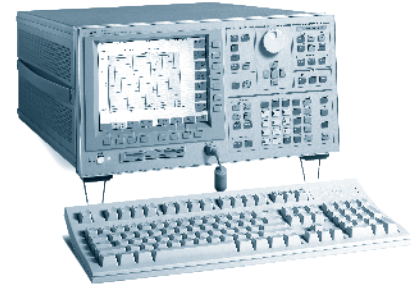

4155C/4156C semiconductor parameter analyzer Series

Proven Technology

Agilent offers the widest selection of instruments for parameter and device analysis available today. Agilent's advanced source/monitor unit (SMU) technology ensures that as semiconductor processes are scaled down and new materials are introduced you will have ample ability to meet these new measurement challenges.

Complete Parametric Test Solutions

The Agilent semiconductor parameter/device analyzer series offers a wide range of choices to meet a variety of different parametric measurement needs. Agilent EasyEXPERT software is resident on both the B1500A and B1505A, providing these products with an intuitive, application-focused measurement method for easy device characterization. The B1500A and B1505A also support a classic

test mode that is familiar to experienced 4155 and 4156 users, and a setup file converter tool is available to allow reuse of 4155 and 4156 test setups on the B1500A. Both products also support a curve tracer mode with knob sweep, and this feature coupled with the B1505A's high-current and high-voltage SMUs make the B1505A an ideal solution to replace aging analog curve tracers.

The Agilent low leakage switch mainframes can augment the measurement capabilities of parameter analyzers (such as the Agilent B1500A, 4155C, and 4156C) and modular SMU instruments (such as Agilent E5260A, E5262A, E5263A, and E5270B) to enable highly automated measurement solutions.

The modular SMU Series have two different areas of focus. The E5270B is targeted at precision semiconductor device characterization; the E5260 Series (E5260A, E5262A, and E5263A) is targeted at high-speed production test.

Powerful EasyEXPERT Software

As previously mentioned, EasyEXPERT software is included with the PC-based B1500A and B1505A. In addition, Agilent supplies Desktop EasyEXPERT free of charge. Desktop EasyEXPERT runs on any Windows XP or Vista based PC, and in online mode it can control the B1500A, B1505A, 4155B/C and 4156B/C. In addition, application tests are available to control the E52070B and E5260A Series using Desktop EasyEXPERT.

Parameter and Device Analyzer

Model	Min current measurement resolution	Min voltage measurement resolution	Max output current	Max output voltage	Max number of SMUs	Key feature	Page
B1500A	0.1 fA	0.5 μ V	\pm 1 A	\pm 200 V	10	PC-based instrument with touch screen. Single box solution for IV, CV, pulse generation, fast IV, and time domain measurement. Includes intuitive and task-oriented EasyEXPERT software	169
B1505A	10 fA	0.2 μ V	\pm 40 A	\pm 3,000 V	5	PC-based instrument with touch screen. Single box solution for IV and CV for power device analysis up to 40 A/3,000 V. Includes intuitive and task-oriented EasyEXPERT software	170
4155C	10 fA	0.2 μ V	\pm 1 A	\pm 200 V	4 (fixed)	Cost-effective parameter analyzer with fixed configuration (4 MPSMU, 2 VSU and 2 VMU). Fill-in-the blank front panel operation; also supported by Desktop EasyEXPERT software	171
4156C	1 fA	0.2 μ V	\pm 1 A	\pm 200 V	4 (fixed)	Highly accurate parameter analyzer with fixed configuration (4 HRSMU, 2 VSU and 2 VMU). Fill-in-the blank front panel operation; also supported by Desktop EasyEXPERT software	171

Modular SMU Series

Model	Min current measurement resolution	Min voltage measurement resolution	Max output current	Max output voltage	Max number of SMUs	Key feature	Page
E5260A	5 pA	100 μ V	\pm 1 A	\pm 200 V	8	High speed parametric test solution with expanded program memory. Up to eight slots for plug-in modules. Code compatible with Agilent 4142B	172
E5262A	5 pA	100 μ V	\pm 200 mA	\pm 100 V	2 (fixed)	High speed parametric test solution with expanded program memory. Fixed configuration with two medium power SMUs. Code compatible with Agilent 4142B	172
E5263A	5 pA	100 μ V	\pm 1 A	\pm 200 V	2 (fixed)	High speed parametric test solution with expanded program memory. Fixed configuration with one medium power SMU and one high power SMU. Code compatible with Agilent 4142B	172
E5270B	0.1 fA	0.5 μ V	\pm 1 A	\pm 200 V	8	Precision parametric test solution with an option for atto-sense and switch unit (ASU). Up to eight slots for plug-in modules. Code compatible with Agilent 4142B	173

Low Leakage Switch Matrix Family

Model	Effective current measurement resolution	Triaxial/coaxial inputs	Max output ports	Settling time (supplemental information)	Bandwidth (supplemental information)	Key feature	Page
B2200A	1 fA	8/6	48	< 50 fA in 2 sec	30 MHz	Supports up to 4 full Kelvin triaxial inputs and up to 48 triaxial outputs. Controllable using Agilent EasyEXPERT software (including capacitance compensation for CV measurement)	174
B2201A	10 fA	8/6	48	< 300 fA in 2 sec	30 MHz	Supports up to 4 full Kelvin triaxial inputs and up to 48 triaxial outputs. Controllable using Agilent EasyEXPERT software (including capacitance compensation for CV measurement)	174
E5250A	20 fA	6/3 or 6/4	96 or 48	N/A	10 MHz	Two matrix cards types supported (matrix card and multiplexer card). Can gang up to four E5250A mainframes together to support up to 384 output channels using the multiplexer cards	175

Web Link

www.agilent.com/find/analyzer

- Superior IV measurement performance: 0.1 fA/0.5 μ V measurement resolution
- Single-box solution for current-voltage (IV), capacitance-voltage (CV), pulse generation, fast IV, and time-domain measurement
- Ten module slots for source monitor units (SMUs) and other module types (MFCMU, HV-SPGU and WGFMU)
- Safe and accurate measurement of semiconductor devices (both on-wafer and packaged)
- Optional positioner-based CV-IV switching solutions available with 0.5 μ V voltage measurement resolution and 10 fA, 1 fA or 0.1 fA current measurement resolution capability
- Offline data analysis and application test development via desktop EasyEXPERT software
- 10 ns pulsed IV solution is available for characterizing high-k gate dielectric and SOI (silicon-on-insulator) transistors
- A classic test mode is available to provide the look, feel, and terminology of the 4155/4156 interface while enhancing user interaction by taking full advantage of Microsoft Windows GUI features



B1500A



16442B test fixture

The Agilent B1500A semiconductor device analyzer is a modular instrument with a ten-slot configuration that supports IV and CV measurements, fast high-voltage pulsing and fast pulsed measurements. Its familiar, Microsoft Windows user interface supports Agilent's EasyEXPERT software, which provides an intuitive task-oriented approach to device characterization. Because of its extremely low-current, low-voltage, and integrated capacitance measurement capabilities, the Agilent B1500A can be used for a wide range of semiconductor device characterization needs. In addition, IC-CAP supports the B1500A for device modeling. It is also an excellent solution for non-volatile memory cell characterization and high-speed device characterization, including advanced NBTI and RTS noise (RTN) measurement.

The Agilent's EasyEXPERT software for the B1500A and desktop EasyEXPERT software for PC-based instrument control provide powerful parametric measurement capabilities. EasyEXPERT software includes over 240 application tests, conveniently organized by device type and function. This expansive test library enables you to become immediately productive on a broad range of measurement and device types without having to spend hours or days learning the instrument hardware.

The B1500A's modular design minimizes costs and protects your investment. Ten module slots and a wide selection of source/monitor units (SMUs) and other state-of-the-art module types let you configure the B1500A exactly the way you want. You also have ample room for expansion if your measurement needs change. And, as Agilent makes new modules available, you can easily add new test capabilities to your B1500A. The ability to meet both known and unanticipated test needs ensures that your parametric test investment is protected well into the future.

Specifications

Mainframe characteristics

- Available slots: 10
- Ground unit sink capability: 4.2 A
- USB ports: 2 front and 2 rear
- Instrument control: GPIB
- Networking: 100 BASE-TX/10 BASE-T LAN Port
- External trigger inputs/outputs: 1 BNC trigger in; 1 BNC trigger out; 8 programmable trigger in/out

Module selection guide for SMU

Module:	HPSMU (B1510A)	MPSMU (B1511A)	HRSMU (B1517A)	ASU (E5288A)
Required slots	2	1	1	NA
Maximum force voltage	± 200 V	± 100 V	± 100 V	± 100 V
Maximum force current	± 1 A	± 100 mA	± 100 mA	± 100 mA
Voltage measurement resolution	2 μ V	0.5 μ V	0.5 μ V	0.5 μ V
Current measurement resolution	10 fA	10 fA	1 fA	0.1 fA

Module selection guide for CMU/SPGU/WGFMU

Module:	Required slot	Main specification
MFCMU (B1520A)	1	1 kHz to 5 MHz, up to 100 V DC bias with SMU
HV-SPGU (B1525A)	1	Min 12.5 ns pulse width, 10 ns transition time, up to 40 V with 3 level pulse
WGFMU (B1530A)	1	Min 100 ns pulse width, 10 V peak-to-peak output, 5 ns current or voltage measurement sampling speed

Ordering Information

B1500A semiconductor device analyzer mainframe

B1500A-015 1.5 m cable (cable length is set to 1.5 m for standard and add-on packages)

B1500A-030 3.0 m cable (cable length is set to 3.0 m for standard and add-on packages)

B1500A-A6J ANSI Z540 compliant calibration

B1500A-UK6 commercial calibration certificate with test data

B1500A-ABA English paper document

B1500A-ABJ Japanese paper document

B1500A-A00 empty package for custom solution

B1500A-A01 standard package (MPSMU 4 ea. & cables)

B1500A-A02 high resolution package (HRSMU 4 ea. & cables)

B1500A-A03 high power package (HPSMU 2 ea, MPSMU 2 ea & cables)

B1500A-A04 basic flash memory cell package (MPSMU 4 ea, SPGU, accessories)

B1500A-A10 HPSMU add-on (HPSMU 1 ea. & cables)

B1500A-A11 MPSMU add-on (MPSMU 1 ea. & cables)

B1500A-A17 HRSMU add-on (HRSMU 1 ea. & cables)

B1500A-A20 MFCMU add-on (MFCMU, cable)

B1500A-A25 HVSPGU add-on (HVSPGU 1 ea. & cables)

B1500A-A28 ASU (atto sense unit) add-on (ASU 1 ea. & cables)

B1500A-A30 WGFMU add-on (WGFMU 1ea, RSU 2 ea. & cables)

B1500A-A31 WGFMU add-on with connector adapter (WGFMU 1 ea, RSU 2 ea, cables & connector adapter)

B1500A-A3P WGFMU probe cable kit (8 probe cables. WGFMU is not included)

B1500A-A5F test fixture for packaged device measurement (16442B 1 ea)

N1301A CMU accessories for B1500

N1301A-100 SMU CMU unify unit (SCUU)

N1301A-102 SMU CMU unify unit cable (3 m)

N1301A-110 SMU CMU unify unit magnetic stand

N1301A-200 guard switch unit (GSWU)

N1301A-201 guard switch unit cable (1 m)

N1301A-202 guard switch unit cable (3 m)

B1540A EasyEXPERT software and measurement libraries

B1540A-001 Agilent EasyEXPERT with license-to-use for standard version

B1540A-002 License-to-use for Agilent EasyEXPERT Plus

B1541A Desktop EasyEXPERT software and measurement libraries

B1541A-001 Desktop EasyEXPERT with license-to-use for standard version

B1541A-002 License-to-use for Agilent desktop EasyEXPERT Plus

B1542A Pulse IV package for B1500 / EasyEXPERT

B1500A
B1510A
B1511A
B1517A
E5288A
B1520A
B1525A
B1530A
B1540A
B1541A
B1542A
N1301A
16442B

Web Link

www.agilent.com/find/b1500a

B1505A
B1510A
B1512A
B1513A
B1520A

- All-in-one solution for power device evaluation
- Voltage force/measure capability up to 3000 V
- Current force/measure capability from sub-picoamp to 40 A
- True curve tracer functionality with knob sweep capability
- Safe and accurate on-wafer high power testing
- Optional test fixture with interlock for safe packaged power device testing
- Flexible configuration with ten module slots for HPSMU, HVSMU, HCSMU and MFCMU modules
- Intuitive EasyEXPERT software simplifies parametric measurement

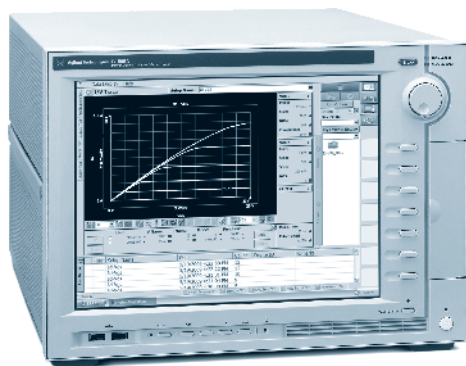

B1505A



N1259A test fixture

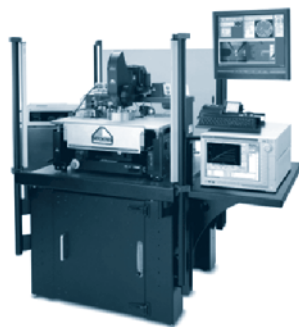

B1505A on semi-auto prober

The Agilent B1505A power device analyzer/curve tracer is the only single box solution available today with the ability to characterize high power devices from the sub-picoamp level up to 3000 volts or 40 amps. These capabilities cover the evaluation needs of new power devices made using wide band gap materials such as silicon carbide (SiC) and gallium nitride (GaN). The B1505A has separate modules that support high-current (HCSMU; up to 20 V/20 A pulsed or 40 V/1 A DC) and high-voltage (HVSMU; up to 8 mA/1500 V or 4 mA/3000 V). The B1505A also supports a high-power SMU (HPSMU; up to 1 A/200 V) and a multi-frequency capacitance measurement unit (up to 5 MHz). In addition, the B1505A's ten-slot modular construction lets you configure it exactly the way you want.

The B1505A software environment allows users to check device characteristics and detect device faults with the easy convenience of a curve tracer. Just like on a curve tracer, the B1505A supports rotary knob control of the independent sweep variable for intuitive and real-time evaluation of parameters such as breakdown voltage. The measurement setup information and data can be automatically stored to the B1505A's built-in hard disk drive and transferred to USB memory sticks as well as other portable storage devices. It is also easy to print graphical measurement data and to copy and paste it into reports when the analysis results are summarized.

A proper high-power test fixture solution is extremely important, both to insure safety (due to the high voltages and currents used) and to support the wide variety of power device package types. A previous curve tracer limitation was that some power devices could not be evaluated due to their size, or it was necessary to jury-rig an adapter in order to test the device. However, the B1505A's test fixture can accept a wide variety of devices, such as power MOSFETs, diodes and IGBTs, regardless of their size or shape utilizing a unique and customizable test fixture adapter. In addition, the test fixture's built-in interlock mechanism ensures that high voltages and currents can be applied to test devices safely. The B1505A also supports on-wafer testing of power devices, thereby eliminating the need to package the devices first. This capability dramatically improves the turn-around-time (TAT) when testing devices in the lab.

Specifications

Mainframe characteristics

- Available slots: 10
- Ground unit sink capability: 4.2 A
- USB 2.0 ports: 2 front and 2 rear
- Instrument control: GPIB
- Networking: 100 BASE-TX/10 BASE-T LAN port
- External trigger inputs/outputs: 1 BNC trigger in; 1 BNC trigger out; 8 programmable trigger in/out

Module

	HPSMU (B1510A)	HCSMU (B1512A)	HVSMU (B1513A)
Maximum force voltage	±200 V	±40 V (DC) ±20 V (Pulse)	±3000 V
Maximum force current	±1 A at ±20 V	±1 A at ±40 V (DC)* ±20 A at ±20 V (pulse)*	±4 mA at ±1500 V ±8 mA at ±3000 V
Voltage measurement resolution	2 µV	200 nV	200 µV
Current measurement resolution	10 fA	10 pA	10 fA

MFCMU (B1520A) key specifications

- Required slot: 1
- Main specification: 1 kHz to 5 MHz, up to 3,000 V DC bias** with bias-T (N1260A) and HVSMU (B1513A)

Ordering Information

B1505A power device analyzer/curve tracer

B1510A high power source monitor unit module (HPSMU)

B1512A high current source monitor unit module (HCSMU)

B1513A high voltage source monitor unit module (HVSMU)

B1520A multi frequency capacitance measurement unit module (MFCMU)

N1259A test fixture for power device

N1258A module selector

N1260A high voltage bias-T

N1261A protection adapter

N1262A R-box

The B1505A is a modular instrument that has ten module slots and supports four different module types. All desired modules and accessories must be specified at time of initial order. The necessary measurement cables for each module are automatically included. Note: since the B1505A is a modular product, you can add new modules to it after initial purchase as long as you have sufficient slots available and you are within the permitted total module power limit.

* Can be increased to ±2 A at ±20 V (DC) and ±40 A at ±20 V (pulse)

** Using high voltage bias-tee (N1260A) and HVSMU (B1513A)

Web Link

www.agilent.com/find/b1505a

- Cost-effective, accurate laboratory bench top parameter analyzer (4155C)
- Highly accurate laboratory bench top parameter analyzer for advanced device characterization (4156C)
- 4 x Medium-power SMU, 2 x VSU and 2 x VMU (4155C)
- 4 x High-resolution SMU, 2 x VSU and 2 x VMU (4156C)
- 10 femtoamp and 0.2 microvolt measurement resolution (4155C)
- 1 femtoamp and 0.2 microvolt measurement resolution (4156C)
- Fill-in-the-blanks front panel operation and Desktop EasyEXPERT software for PC-based GUI instrument control
- Full Kelvin; force, sense and guard connection for each SMU (4156C)
- QSCV, stress mode, knob-sweep, stand-by function
- ±200 Volts and ±1 Amp high-power SMU, pulse generator capabilities available by optional 41501B

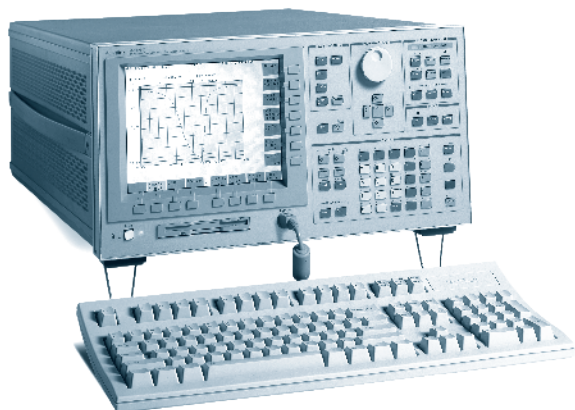

4156C

The 4155C semiconductor parameter analyzer provides cost-effective, accurate laboratory bench top parameter analyzers for advanced device characterization. The 4156C precision semiconductor parameter analyzer provides highly accurate laboratory bench top parameter analyzers for advanced device characterization. The low-current and low-voltage resolution and built-in quasi-static CV measurement capability of the 4155C and 4156C provide a firm foundation for future expansion with other measurement instruments.

The 41501B expander can extend your capabilities to 1A/200V as well as supporting dual pulse generator units (PGUs) and a 1.6 A ground unit.

Desktop EasyEXPERT Software Capabilities

The Agilent Desktop EasyEXPERT, which is included with the 4155C and 4156C, is able to control the Agilent 4155B/4156B and 4155C/4156C semiconductor parameter analyzers from your PC and provides following key features.

- An innovative task oriented approach user interface
- Easy test automation with built-in semi-automatic prober drivers
- Test sequencing without programming via quick test mode
- A classic test mode to provide the look, feel, and terminology of the 4155/4156 interface
- Intuitive GUI-based switching matrix control for the B2200A, B2201A, and E5250A (optional)

In addition, the Desktop EasyEXPERT also provides the same test environment as used in the Agilent B1500A semiconductor device analyzer and B1505A power device analyzer/curve tracer.

Specifications

SMU measurement range

- Voltage: 2 μ V/200 V*
- Current: 10 fA/1 A* (4155C), 1 fA/1 A* (4156C)

SMU measurement resolution

- Voltage: 2 μ V
- Current: 10 fA (4155C), 1 fA (4156C)

SMU measurement basic accuracy

- Voltage: 0.02%
- Current: 0.1%
- SMU pulse width: 500 μ s/100 ms

VMU

- Resolution: 2 μ V
- Basic accuracy: 0.02 %

VMU (differential)

- Resolution: 0.2 μ V
- Basic accuracy: 0.02 %

Dual high voltage pulse generator

- Voltage range: \pm 40V
- Output current: \pm 200 mA
- Minimum pulse width: 1 μ s
- Minimum pulse period: 2 μ s

Ordering Information

4155C semiconductor parameter analyzer

4156C precision semiconductor parameter analyzer

41501B pulse generator and expander unit for the 4155C/4156C

* The 200 V and 1 A ranges are available when using the Agilent 41501B with the HPSMU option

Web Link

www.agilent.com/find/4155c

www.agilent.com/find/4156c

4155C
4156C
41501B

E5260A
E5290A
E5291A
E5262A
E5263A

- **Eight module slots (E5260A): Flexibility now and expandability in the future**
- **Two SMU fixed configurations (E5262A, E5263A): Cost-effective solutions provide just enough test capability**
- **SMUs that measure several times faster than 4142B SMU: Faster test times and improved throughput, resulting in a lower cost-of-test**
- **Code compatible with the 4142B: Replace current 4142Bs with the E5260A Series and enjoy a large throughput improvement with only minimal test code modification**
- **16 digital I/O lines for instrument triggering in addition to BNC trigger-in and trigger-out connectors: Sophisticated triggering schemes involving multiple instruments can easily be created**
- **All trigger signals are processed via hardware rather than firmware: Fastest possible trigger response from the instrument**
- **Front panel control: Can conveniently perform and report spot measurements via a simple front-panel interface, without programming. View other items of interest, such as error messages, valuable when debugging the instrument performance under automated control**
- **Free desktop EasyEXPERT software supports E5260A Series: The combination of desktop EasyEXPERT with the E5260A Series provides a easy-to-use yet cost-effective parametric measurement environment for research and development from industry to academic use**



E5260A



E5262A



E5263A

Fast Measurement that Lowers Cost-of-Test

The fast measurement speed of the E5260A Series makes it an ideal choice for not only high-speed production test but also cost-effective R&D test for technologically advanced devices of today and tomorrow, the Agilent E5260A Series lowers your cost-of-test with a high-speed parametric test solution for semiconductor, RFIC, and optical component testing. Based on well-proven Agilent 4070/4080 Series system technology, the E5260A provides superior measurement throughput that is several times faster than earlier products such as the Agilent 4142B.

The E5260A is modular, which enables customization now and provides for future expansion as requirements change. The E5262A includes two MPSMU and a ground unit and the E5263A includes one MPSMU, one HPSMU and a ground unit, providing just enough test capability for many component-test needs. A number of innovative design elements help to improve the efficiency of complex testing, such as expanded program memory to accelerate the measurement process, and 16 digital I/O lines for sophisticated triggering requirements. Moreover, historically encountered power limitations on the instrument mainframe (such as often occur with the 4142B) have been eliminated. In addition, Agilent desktop EasyEXPERT software, which provides a unified parametric measurement environment with easy-to-use user interface, can control the product family by using sample application tests.

Specifications

Mainframe characteristics

E5260A 8 slot high speed measurement mainframe

- Available slots: 8
- Ground unit (GNDU) sink capability: 4.0 A
- Instrument control: GPIB
- External trigger inputs/outputs: 1 BNC trigger in; 1 BNC trigger out; 8 programmable trigger in/out

E5262A 2 channel (medium power, medium power) SMU

- Available slots: two channel (2X MPSMU) fixed configuration
- Ground unit (GNDU) sink capability: 2.2 A
- Instrument control: GPIB
- External trigger inputs/outputs: 1 BNC trigger in; 1 BNC trigger out; 8 programmable trigger in/out

E5263A 2 channel (high power, medium power) SMU

- Available slots: two channel (HPSMU and MPSMU) fixed configuration
- Ground unit (GNDU) sink capability: 2.2 A
- Instrument control: GPIB
- External trigger inputs/outputs: 1 BNC trigger in; 1 BNC trigger out; 8 programmable trigger in/out

Module selection guide

	E5290A high speed HPSMU	E5291A high speed MPSMU
Required slots	2	1
Maximum force voltage	±200 V	±100 V
Maximum force current	±1 A	±200 mA
Voltage measurement resolution	100 µV	100 µV
Current measurement resolution	5 pA	5 pA

Ordering Information

- E5260A 8 slot high speed measurement mainframe
- E5290A high speed type high power SMU module
- E5291A high speed type medium power SMU module
- E5262A 2 channel (medium power, medium power) SMU
- E5263A 2 channel (high power, medium power) SMU

The E5260A does not have any base configuration. All desired modules, accessories, and cables must be specified at the time of order. Note: Since the E5260A is a modular product, you can add new modules to it at any time after initial purchase as long as you have slots available.

The E5262A and E5263A are fixed-configuration products; there are no options or required accessories.

Web Link

www.agilent.com/find/msmu

- **Eight module slots: Flexibility now and expandability in the future.** A wide selection of SMUs from high power to ultra low current measurement capabilities let you configure the E5270B exactly the way you want
- **HRSMU has 1 femtoamp current measurement resolution: Can meet the measurement challenges posed by the vast majority of current and future devices, without the need for external preamplifiers**
- **HRSMU combines with optional atto sense and switch unit (ASU) to achieve 100 attoamp current measurement resolution: Stable 100 attoamp current resolution via remote sensing meets the most demanding ultra low current measurement requirements**
- **Switch between CV and IV measurements on positioners via software commands with ASU: No need to physically change cabling or move to a different probe station when changing from CV to IV measurement**
- **MPSMU and HRSMU can measure voltage with 0.5 microvolt resolution. Both SMUs also support new 0.5 V and 5 V measurement ranges: Enables you to perform very demanding component matching and metal line resistance voltage measurements with ease**
- **Free desktop EasyEXPERT software supports E5270B: The combination of desktop EasyEXPERT with E5270B provides a powerful yet cost-effective parametric measurement environment for industry, R&D and academic use**
- **Code compatible with 4142B: Enables you to reuse existing programs with only minor modification**

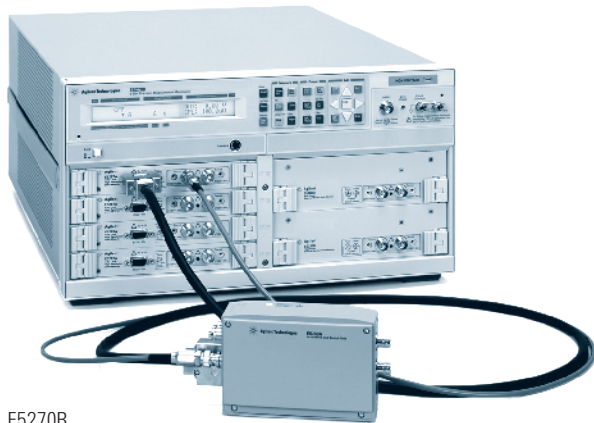

E5270B

Solves the Most Extreme Parametric Measurement Challenges

The E5270B offers a flexible, expandable, and upgradeable solution for parametric characterization of semiconductor devices, with voltage measurement resolution down to 0.5 μ V and current measurement resolution down to 0.1 fA. Three different source/monitor unit (SMU) types are available to meet a variety of parametric measurement challenges: a medium power SMU (MPSMU), a high power SMU (HPSMU), and a high resolution SMU (HRSMU). An optional atto-sense and switch unit (ASU) works with the HRSMU to provide 100 aA (attoamps) of current measurement resolution. The ASU enables switching between SMU-based measurement (IV) and capacitance meter based measurement (CV) without having to change any cables. Agilent desktop EasyEXPERT software, which provides a unified parametric measurement environment with easy-to-use user interface, can control the E5270B using sample application tests. Agilent also provides an industry-standard VXIplug&play instrument driver as a cost-effective programming aid when using your own testing software.

E5270B
E5280B
E5281B
E5287A
E5288A

Specifications

Mainframe characteristics

E5270B 8-slot precision measurement mainframe:

- Available slots: 8
- Ground unit (GNDU) sink capability: 4.0 A
- Instrument control: GPIB
- External trigger inputs/outputs: 1 BNC trigger in; 1 BNC trigger out; 8 programmable trigger in/out

Module selection guide

	E5280B HPSMU	E5281B MPSMU	E5287A HRSMU	E5288A ASU
Required slots	2	1	1	N/A
Maximum force voltage	± 200 V	± 100 V	± 100 V	± 100 V
Maximum force current	± 1 A	± 100 mA	± 100 mA	± 100 mA
Voltage measurement resolution	2 μ V	0.5 μ V	0.5 μ V	0.5 μ V
Current measurement resolution	10 fA	10 fA	1 fA	0.1 fA

Ordering Information

- E5270B 8 slot precision measurement mainframe
- E5280B precision high power SMU module
- E5281B precision medium power SMU module
- E5287B high resolution SMU module
- E5288A atto sense and switch unit (ASU)

The E5270B does not have any base configuration. All desired modules, accessories, and cables must be specified at the time of order. Note: Since the E5270B is a modular product, you can add new modules to it at any time after initial purchase as long as you have slots available.

Web Link

www.agilent.com/find/msmu

B2200A
B2201A
B2210A
B2211A

- **Lighted display of relay status for fast verification and debug of measurement setups**
- **Front panel control support via keypad or optional light pen**
- **Agilent EasyEXPERT software can control and automate switch settings via an intuitive GUI**
- **Optimized CV inputs with integrated EasyEXPERT software capacitance compensation**
- **1 femtoamp (B2200A) or 10 femtoamp (B2201A) measurement resolution through the switch using 4156C, B1500A, or E5270B HRSMU**
- **30 MHz bandwidth (–3dB)**
- **Channel isolation of 100 teraohms (B2200A) or 50 teraohms (B2201A) for low-current (triaxial) paths**

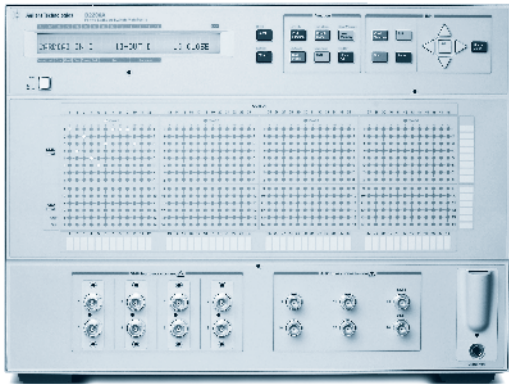

B2200A

3

The B2200A fA leakage switch mainframe and B2201A low leakage switch mainframe provide exceptional low-current leakage and capacitance measurement performance, without the limitations imposed by alternative solutions. The ability to support 1 fA (B2200A) or 10 fA (B2201A) measurements means that these switching matrices do not detract from the high-performance of the semiconductor parameter analyzer or semiconductor device analyzer. Sufficient inputs are available to support a 4-SMU, full-Kelvin configuration. All 14 inputs correspond to unique internal paths, so all inputs can be used simultaneously. Unlike competing solutions, capacitance measurement results are not distorted by the inherent error introduced by each channel's varying path lengths; the system provides the parameters and algorithms necessary to compensate for these variances. A modular and flexible architecture supports 12, 24, 36 or 48 output configurations. The 30 MHz bandwidth permits the use of instruments such as pulse generators. Flexible operator control is provided by the LED display and the keypad or optional light pen user interface.

No Multiplexed Input Limitations

Avoid delays and time-consuming manual switching with the B2200A's or B2201A's 14 internal measurement paths. Every input has its own unique internal path, enabling you to use all inputs simultaneously.

Accurate Capacitance Measurements

When measuring capacitance, the cable length, which includes the path through the matrix, has a significant impact on measurement results. When using the two BNC inputs that are optimized for capacitance measurement, the B2200A and B2201A switching matrix mainframe – unlike competitive solutions – corrects for the error introduced by the matrix's internal path lengths, supplying compensation parameters to enable undistorted measurement results.

Specifications

Number of ports

- IV port: 8 triaxial ports (with guard)
- AUX port: 6 BNC ports (2 CV port)
- Output channel: triaxial ports (with guard), x12, x24, x36, and x48 configurations available

Number of slots

- 4 slots for 48 mm height switch module

Max current rating

- IV port: 1.0 A
- AUX port: 0.5 A

Max voltage rating

- IV port (other Ch): 200 V
- IV port (common): 300 V
- AUX port (other Ch): 100 V
- AUX port (common): 100 V

Channel isolation

- IV (triaxial) port:
 - 1 x 10¹⁴ (ohm) (B2200A)
 - 5 x 10¹³ (ohm) (B2201A)
- AUX (coaxial) port: 1 x 10⁹ (ohm)

Effective current measurement resolution (supplemental)

- IV (triaxial) port:
 - 1 fA* (B2200A)
 - 10 fA* (B2201A)

Offset current (supplemental)

- IV port: 100 fA

IM noise (RMS) (supplemental)

- IV port: 5 fA

Additional C measurement error (supplemental)

- < ±1% + 0.2 pF

Bandwidth (at -3dB; supplemental)

- 30 MHz

Settling time (supplemental)

- 2.0 sec at 300 fA

Ordering Information

B2200A fA leakage switch mainframe

B2210A fA leakage switch module

B2201A 14ch low leakage switch mainframe

B2211A 14ch low leakage switch module

The B2200A switch mainframe does not include any matrix cards. You must specify from 1 – 4 of the B2210A matrix cards at the time of order. You can add additional B2210A matrix cards (up to 4 maximum per B2200A) at a later date.

The B2201A switch mainframe does not include any matrix cards. You must specify from 1 – 4 of the B2211A matrix cards at the time of order. You can add additional B2211A matrix cards (up to 4 maximum per B2201A) at a later date.

* Typical measurement performance when using the B2200A or B2201A with the 4156C, E5270B, or B1500A high-resolution SMU

Web Link

www.agilent.com/find/swm

- Two matrix card types supported: E5252A matrix cards and E5255A multiplexer cards
- E5252A matrix cards support cost-effective non-Kelvin switching matrix functionality
- E5255A multiplexer cards support long-term multisite reliability testing
- Agilent EasyEXPERT software can control and automate switch settings using application tests
- 20 femtoamp measurement resolution through the switch using the B1500A's or E5270B's HRSMU, or using the 4156C
- 10 MHz bandwidth (-3 dB) using E5252A cards

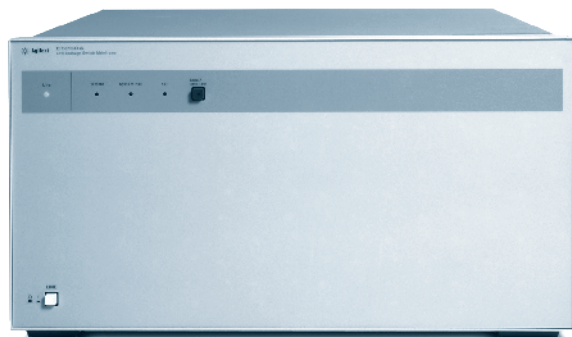

E5250A

The Agilent E5250A low leakage switch supports non-Kelvin measurement on four SMUs, with six additional multiplexed inputs for other needs. Besides supporting traditional matrix functionality (Agilent E5252A cards), the E5250A also supports long-term reliability stress testing (Agilent E5255A cards). The E5250A can be configured with one to four output cards or either type. The E5250A also supports a VXIplug&play driver for easy programmatic control.

The E5250A and E5252A matrix card combine to form a basic non-Kelvin matrix solution. The E5252A card has 6 triaxial inputs and 4 BNC inputs, with 6 internal paths. The inputs to internal rows 5 and 6 consist of 3-to-1 multiplexers. This configuration maintains cost-effectiveness without sacrificing essential CV-IV measurement performance.

The E5250A supports the E5255A multiplexer card for long-term reliability stress testing. The multiplexer card has 24 outputs, organized in groups of 8. Each card has one multilevel DC bias input for each set of eight channels, permitting the use of inexpensive power suppliers for consistent stress. The E5250A accepts four of these cards, for a total of 96 outputs. Each channel can also have a user-selected protection resistor to limit the current surge after device breakdown or rupture. You can gang up to four E5250A mainframes together using the E5255A cards to create a system with 384-channel capability.

Specifications

Matrix switch (specification defined with the mainframe)

Max current rating

- Port: 1.0 A

Max voltage rating

- Channel to ground: ~ 200 V
- Channel to channel: ~ 300 V

Close channel residual resistance

- Low-leakage IV port: ~ 0.6 ohms
- General IV port: ~ 1.0 ohms

Channel isolation

- Low-leakage IV port: $\sim 10E13$ ohms
- General IV port: $\sim 10E12$ ohms
- CV, HF port: $\sim 10E9$ ohms

24 channel multiplexer (specification defined with the mainframe)

Max current rating

- Port: 1.0 A

Max voltage rating

- Channel to ground: ~ 200 V
- Channel to channel: ~ 300 V

Close channel residual resistance

- Low-leakage IV port: ~ 0.6 ohms
- General IV port: ~ 1.0 ohms

Channel isolation

- Low-leakage IV port: $\sim 10E13$ ohms
- General IV port: $\sim 10E12$ ohms
- CV, HF port: $\sim 10E9$ ohms

Measurement capabilities (supplemental characteristics)

- Effective current measurement resolution: 20 fA*
- Transient current settling time (10 V input step): < 3.5 sec at 400 fA
- Bandwidth (at -3 dB, using E5252A cards): 10 MHz

Ordering Information

E5250A low leakage switch mainframe

E5252A 10 x 12 matrix card

E5255A 24 channel multiplexer card

The E5250A switch mainframe does not include any matrix cards. You must specify either E5252A matrix cards or E5255A multiplexer cards at the time of order. The mainframe holds up to four cards, and both card types can exist simultaneously in the mainframe.

* Typical measurement performance when using the E5250A with the B1500A, E5270B high-resolution SMU, or 4156C

Web Link

www.agilent.com/find/swm

E5250A
E5252A
E5255A

4082A
4082F
4083A

- Accurate and reliable DC current and voltage measurement with 1 femtoamp and 0.1 microvolt measurement resolution capability synchronous parallel test capability and optional asynchronous parallel test capability via Agilent's virtual multiple testhead technology
- An optional high-speed capacitance measurement unit (HSCMU) for high-throughput capacitance measurement
- Flash cell write/erase endurance testing via integrated high-voltage semiconductor pulse generator units (HV-SPGUs) with -40 to +40 V (80 V peak-to-peak) output capability [4082F and 4083A]
- RF S-parameter measurement at up to 20 GHz with support for an optional 8 x 10 RF switching matrix [4083A]
- Software compatibility to Agilent 4070 Series
- Full compliance with SEMI factory automation standards E5 (SECS II), E30 (GEM), E87 (CMS), E39 (OSS), E40 (PMS), E90 (STS), and E94 (CJM)



Agilent 4080 parametric tester with automatic wafer prober

New Wafer Fabs Face Increased Measurement Challenges

The parametric testing challenges facing new wafer fabs are intensifying, and they will continue to intensify into the future. The need to make accurate and reliable DC voltage and current measurements remains very important. However, parametric test has moved away from the realm of pure DC measurement and has branched out into many new directions. Parametric test now spans a variety of different types of measurements including parallel test, Flash cell testing, and RF S-parameter characterization. Wafer fabs running advanced processes require a more versatile and flexible platform to adequately meet this broad spectrum of parametric measurement challenges.

A Family of Solutions that Meets Both Basic and Advanced Measurement Needs

Building on the well-proven parametric test capabilities of the industry-standard Agilent 4070 Series, the Agilent 4080 Series of parametric testers are modular and expandable production test platforms with the capabilities to meet all of the parametric characterization challenges posed by the most advanced semiconductor processes. Besides having a flexible configuration at time of purchase, each 4080 platform also has the ability to easily add new testing capabilities if your measurement needs change. All members of the 4080 Series can also run existing 4070 test algorithms with little or no modification, which minimizes transition costs while ensuring that your new capital investment is protected for many years into the future. The 4080 Series consists of three products optimized for different market segments. The 4082A is focused on high-speed general-purpose parametric test; the 4082F is focused on parametric test of flash memory processes; the 4083A is focused on the evaluation of high-speed semiconductor processes.

Specifications

Agilent 4080 Series common specifications (Agilent 4082A parametric test system)

Standard resources

- MPSMU (up to 8):
 - 10 fA and 2 μ V resolution
 - 100 V and 100 mA maximum output
- HPSMU (up to 2):
 - 10 fA and 2 μ V resolution
 - 200 V and 1 A maximum output
- HRSMU (up to 2)*:
 - 1 fA and 2 μ V resolution
 - 100 V and 100 mA maximum output
- GNDU: 1.6 A @ 0 V
- DC switching matrix (12 to 48 output pins):
 - 6 full Kelvin active guarded paths
 - 8 auxiliary input ports
 - 48 extended path inputs
 - 48 full Kelvin active guarded outputs
 - 2 active-guarded shielded low-current paths (non-Kelvin)*

Agilent 4082F flash memory cell parametric test system extension

- HV-SPGU (up to 5):
 - -40 to +40V output (80 V peak-to-peak)
 - 20 ns transition times
 - 2-level and 3-level pulses

Agilent 4083A DC/RF parametric test system extension**

- RF switching matrix:
 - Two block of 4 x 5 matrices configuration
 - 20 GHz bandwidth
- Agilent E8362C PNA network analyzer: 10 MHz to 20 GHz***

Optional integrated resources:

- Agilent 3458A DVM
 - 0.1 μ V resolution*
 - 1 μ V resolution
- HSCMU (up to 1)
 - 1 fF to 10 nF measurement range
 - 1 kHz to 2 MHz frequencies
- Agilent E4980A LCR meter
 - 1 fF to 10 nF measurement range
 - 1 kHz, 10 kHz, 100kHz, and 1 MHz frequencies
- HF switching matrix
 - One 3 x 48 or two 3 x 24 matrices
 - Pulse switch

Ordering Information

The Agilent 4080 Series testers are system products and must be configured in consultation with an Agilent sales professional specializing in these products.

* Requires ultra low-current matrix cards
** 4083A can also feature HV-SPGU extension
*** RF direct connection

Web Link

www.agilent.com/find/4080



Generators, Sources, Supplies

Signal Generators	178
Function/Arbitrary Waveform Generators	208
Pulse Generators, Data Generators and Analyzers	214
DC Power Supplies/Analyzers/Electronic Loads/ AC Power Solutions	219
Source Measure Units	240

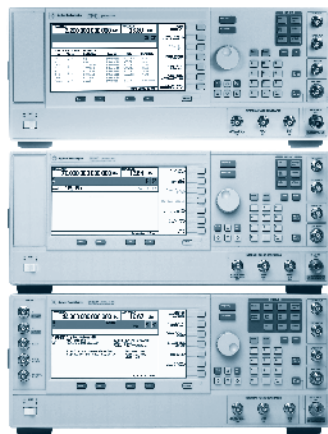

PSG signal generators

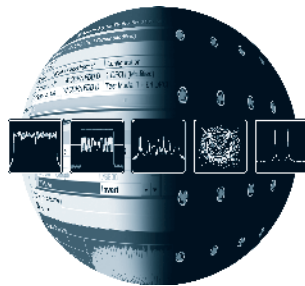

Signal Studio software

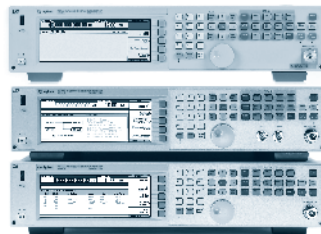

MXG signal generators



N9310A signal generator



N5106A PXB

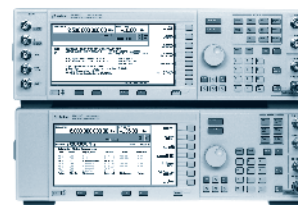

ESG signal generators

Analog and Vector Signal Generators

Agilent offers the widest selection of signal generators from baseband to 67 GHz, with frequency extensions to 500 GHz. From basic to advanced functionality, each signal generator delivers benchmark performance in its class to address the requirements in design and manufacture of radio transceivers and their components; and applications ranging from low-frequency navigation signals, through cellular mobile radio, to millimeter wave satellite systems. Each offers synthesized frequency accuracy and stability, excellent calibrated level accuracy, and remote programmability. Modulation capabilities vary from general purpose AM, FM, Φ M, and I/Q modulation, to standard-specific formats such as GSM, W-CDMA, HSPA, LTE, cdma2000, and WiMAX.

Signal Studio Software

Agilent is a worldwide leader in complex signal simulation, boasting the most comprehensive collection of application-specific signal creation software. With a proven first-to-market track record, Agilent continues to help you stay at the forefront of product development for modern communications systems, including those for LTE FDD and TDD, W-CDMA, digital video, and GPS.

Agilent vector signal generators feature both Signal Studio software that runs on a PC, as well as embedded software that runs directly on the signal generator. Both of these flexible, easy-to-use signal creation solutions will cut the time you spend on signal simulation and provide a validated reference signal to better characterize, evaluate, and optimize your designs under parametric and functional test conditions. Create reference signals for mobile communications and wireless connectivity standards, test patterns for advanced radar systems, distortion test signals for components, and more.

Baseband Generation

Baseband generation products enable baseband and RF designers to generate, capture, impair, play back, and emulate real-world signal conditions. Use the N5106A PXB baseband generator and channel emulator to test receiver signal processing to standards and beyond. The PXB is the only instrument that combines multi-format baseband generation, real-time fading, and signal capture in a single box. At any stage of the R&D lifecycle, you can use the PXB to quickly diagnose and troubleshoot designs.

The N5102A digital signal interface module provides fast and flexible digital inputs and outputs for your E4438C ESG, E8267D PSG vector signal generator, and N5106A PXB baseband generator and channel emulator.

Analog Signal Generators

Model	Frequency range	Key feature/application	Page
N9310A	9 kHz to 3 GHz	Basic performance; low-cost RF signal generation for general-purpose and consumer product manufacturing; provides built-in analog modulation and optional I/Q analog inputs; multi-language user interface	193
N5181A MXG	100 kHz to 1, 3, 6 GHz	Mid-performance; optimized for manufacturing; provides fast frequency and amplitude switching, simplified self-maintenance, and LXI Class B compliance	189
N5183A MXG	100 kHz to 20, 31.8, 40 GHz	Mid-performance; perform a wide variety of microwave measurements that require high output power and fast tuning in a compact, 2U high package	191
E4428C ESG	250 kHz to 3, 6 GHz	High performance; ideal for general-purpose R&D applications, including LO substitution, component, and receiver test; provides excellent spectral purity, high output power, and flexible dual internal function generator	187
E8663D PSG	100 kHz to 3.2, 9 GHz	High performance; meets needs of demanding applications such as radar system development, satellite communications evaluation, or very low noise local oscillator substitution; provides the best close-to-carrier and pedestal phase noise, high output power, and excellent level accuracy	185
E8257D PSG	250 kHz to 20, 31.8, 40, 50, 67 GHz	High performance; ideal for developing radar systems, satellite communications, terrestrial microwave radios, and their components; provides industry-leading phase noise, high output power, and excellent level accuracy for LO substitution, component and receiver test	181
OML Inc. Millimeter-wave source modules	50 to 500 GHz	Frequency extension to 500 GHz for E8257D and E8267D PSG signal generators	184

Signal Sources

Vector signal generators

Model	Frequency range	Key feature/application	Page
N5182A MXG	100 kHz to 3, 6 GHz	Mid-performance; optimized for manufacturing and key R&D applications including MCPA development and transceivers for LTE and WLAN; provides arbitrary signal generation, industry-leading ACPR, fast switching and simplified self-maintenance; LXI Class B compliance; use with Signal Studio software for standards-based signal creation for mobile communications and wireless connectivity and audio/video broadcasting; works with the N5106A PXB for real-time fading, signal capture, and digital I/Q inputs and outputs	201
E4438C ESG	250 kHz to 1, 2, 3, 4, 6 GHz	High performance; offers flexible RF signal generation for R&D; provides arbitrary and real-time signal generation; use with Signal Studio software for the broadest offering of standards-based signal creation for audio/video, mobile communications, wireless connectivity, and more; works with the N5106A PXB for real-time fading, signal capture, and digital I/Q inputs and outputs	199
E8267D PSG	250 kHz to 20, 31.8, 44 GHz	High performance; ideal for developing radar systems, satellite communications, and terrestrial microwave radios and their components; provides industry-leading phase noise and microwave custom I/Q modulation; works with Signal Studio software for complex pulse generation as well as two-tone and multi-tone signals for distortion test; works with the N5106A PXB for real-time fading, signal capture, and digital I/Q inputs and outputs	195

Signal Studio software

Industry	Frequency range	Signal type	Page
Mobile communications	Signal generator dependent	<ul style="list-style-type: none"> • LTE, W-CDMA, HSDPA, HSUPA • GSM, EDGE, GPRS, EGPRS • cdmaOne, cdma2000, 1xEV-DO • TD-SCDMA • NADC, PDC, PHS, DECT, TETRA 	203
Wireless connectivity	Signal generator dependent	<ul style="list-style-type: none"> • 802.16 WiMAX (fixed and mobile) • 802.11 WLAN (a/b/g/j/p/n) • Bluetooth • MB-OFDM UWB 	
Audio/video broadcasting	Signal generator dependent	<ul style="list-style-type: none"> • DVB-T/T2/H/C/S/S2 • J.83 A/B (DOCSIS DS)/C • ATSC • ISDB-T • CMMB • DTMB • T/S-DMB • FM Stereo/RDS • DAB/DAB+ 	
Detection, positioning, tracking & navigation	Signal generator dependent	<ul style="list-style-type: none"> • Pulse building • GPS 	
General RF/MW	Signal generator dependent	<ul style="list-style-type: none"> • Toolkit • Multitone distortion • Calibrated AWGN • Jitter injection 	

Baseband generation

Model	Type	Key feature/application	Page
N5102A digital signal interface module	Hardware	Enables digital outputs from and digital inputs to the N5106A PXB baseband generator and channel emulator, the E4438C ESG and E8267D PSG vector signal generators and custom transceivers	206
N5106A PXB baseband generator and channel emulator	Hardware	Ideal for testing receiver signal processing to standards and beyond. The PXB combines multi-format baseband generation, real-time fading, and signal capture in a single box. Use the PXB to quickly diagnose and troubleshoot designs in R&D	205

N9310A
N5181A
N5183A
E4428C
E8663D
E8257D



N9310A



E4428C ESG



N5181A MXG



E8663D PSG



N5183A MXG



E8257D PSG

Analog Signal Generators

Agilent analog signal generators span from economy RF to high performance microwave frequencies and offer precision AM, FM, Φ M, and pulse modulation. They feature excellent spectral purity for LO substitution, superior level accuracy, high output power, as well as digital (step/list) and analog (ramp) sweep with scalar network analyzer compatibility. If you need a repeatable test stimulus to manufacture high-volume, low-cost products, or have more demanding performance requirements for your sensitivity, adjacent channel, and intermodulation measurements, Agilent analog signal generators deliver.

Side-by-Side Key Specifications Comparison

	Basic performance	Mid performance	Mid performance	High performance	High performance	High performance
	N9310A Page 193	N5181A MXG Page 189	N5183A MXG Page 191	E4428C ESG Page 187	E8663D PSG Page 185	E8257D PSG Page 181
Key attributes	<ul style="list-style-type: none"> • Low cost • Large (6.5"), easy to operate color screen • Optional I/Q modulator (ext. I/Q inputs only) • Localized GUI with 11 regional languages 	<ul style="list-style-type: none"> • Optional analog modulation • Fast switching speed • Simplified self-maintenance • Compact two rack unit size (2RU) 	<ul style="list-style-type: none"> • Optional analog modulation • Fast switching speed • High output power • Compact two rack unit size (2RU) 	<ul style="list-style-type: none"> • Excellent spectral purity • High output power • Dual internal function generators 	<ul style="list-style-type: none"> • Industry's best SSB phase noise • Superior level accuracy • High output power • Narrow pulse modulation 	<ul style="list-style-type: none"> • Industry's best SSB phase noise • High output power • Excellent level accuracy • Optional analog modulation • Narrow pulse modulation
Frequency range	9 kHz to 3 GHz	100 kHz to 1, 3, or 6 GHz	100 kHz to 20, 31.8 or 40 GHz	250 kHz to 3 or 6 GHz	100 kHz to 3.2 or 9 GHz	250 kHz to 20, 31.8, 40, 50, 67 GHz
Output power	+13 to -127 dBm	+23 to -127 dBm	+18 to -130 dBm	+17 to -136 dBm	+21 to -135 dBm	+23 to -135 dBm
Level accuracy	±1 dB	±0.6 to 1.7 dB	±0.6 to 2.0 dB	±0.5 to 1.5 dB	±0.6 to 1.0 dB	±0.6 to 2.5 dB
Spectral purity	Close-in SSB Phase noise (1 GHz; 10 Hz offset)	-60 dBc/Hz (measured)	-58 dBc/Hz (measured)	-80 dBc/Hz (measured)	-93 dBc/Hz (typical)	-93 dBc/Hz (typical)
	SSB phase noise (1 GHz; 20 kHz offset)	-95 dBc/Hz	-121 dBc/Hz (typical)	-116 dBc/Hz (typical)	-134 dBc/Hz	-146 dBc/Hz
	Far-from carrier SSB phase noise (1 GHz; 10 MHz offset)	-160 dBc/Hz (measured)	-160 dBc/Hz (measured)	-147 dBc/Hz (measured)	-150 dBc/Hz (measured)	-150 dBc/Hz (measured)
	Microwave SSB Phase noise (10 GHz; 10 kHz offset)		-102 dBc/Hz (measured)			
	Harmonics	< -30 dBc	< -30 to < -44 dBc	< -28 to < -56 dBc	< -30 dBc	< -30 to < -55 dBc
	Nonharmonics	< -50 dBc	< -42 to < -61 dBc	< -45 to < -62 dBc	< -62 to < -80 dBc	< -62 to < -80 dBc
Frequency switching	< 10 ms	< 1.15 ms < 900 μ s (list mode)	< 1.15 ms < 900 μ s (list mode)	< 9 ms	< 8 ms	< 8 ms
Jitter (@ 622 MHz, 5 MHz BW)	—	47 μ UI	47 μ UI	40 μ UI	19 μ UI	19 μ UI

- Highest output power up to 67 GHz
- Excellent phase noise performance
- Ramp sweep and scalar analyzer interface available
- Frequency coverage up to 500 GHz for CW and analog modulation applications



E8257D PSG CW and Analog Signal Generator

LO Substitution and Component Test Applications

- Industry leading high output power
- Enhanced ultra-low phase noise
- Superior level accuracy
- Code compatibility with other Agilent microwave signal generators
- Ramp sweep capability with fast sweep rate
- Automatic operation with the 8757D scalar network analyzer is included with Option 007 ramp sweep capability

Advanced Communication Testing of Receiver Quality, Transmitter Sensitivity and Selectivity

Select optional modulation and receive:

- Flexible analog modulation formats: AM, FM, Φ M and pulse
- Internal modulation with sine, square, triangular, ramp, and noise waveforms
- Narrow pulse modulation (20 ns) down to 10 MHz

Specifications

Frequency

Range

- Option 520: 250 kHz to 20 GHz
- Option 532: 250 kHz to 31.8 GHz
- Option 540: 250 kHz to 40 GHz
- Option 550: 250 kHz to 50 GHz
- Option 567: 250 kHz to 67 GHz

Resolution

- CW: 0.001 Hz
- All sweep modes: 0.01 Hz

Switching speed

- < 10 ms (typical)

Phase offset

- Adjustable in nominal 0.1° increments

Frequency bands

Band	Frequency range	N
1	250 kHz to 250 MHz	1/8
2	> 250 to 500 MHz	1/16
3	> 500 MHz to 1 GHz	1/8
4	> 1 to 2 GHz	1/4
5	> 2 to 3.2 GHz	1/2
6	> 3.2 to 10 GHz	1
7	> 10 to 20 GHz	2
8	> 20 to 40 GHz	4
9	> 40 GHz	8

Internal timebase reference oscillator

- Aging rate: $< \pm 3 \times 10^{-8}$ /year or $< \pm 2.5 \times 10^{-10}$ /day after 30 days

Temperature effects (typical)

- $< \pm 4.5 \times 10^{-9}$ 0 to 55 °C

Line voltage effects (typical)

- $< \pm 2 \times 10^{-10}$ for $\pm 10\%$ change

External reference frequency

- 10 MHz only (within 1 ppm)

Step (digital) sweep

Operating modes

Step sweep of frequency or amplitude or both (start to stop)

List sweep of frequency or amplitude or both (arbitrary list)

Sweep range

- Frequency sweep: within instrument frequency range
- Amplitude sweep: within attenuator hold range

Dwell time 1 ms to 60 s

- Frequency settling time: 28 ms (typical)
- Amplitude settling time: 10 ms (typical)

Number of points

- Step sweep: 2 to 65535
- List sweep: 2 to 1601 per table

Triggering

- Auto, external, single, or GPIB

Ramp (analog) sweep (Option 007)

Operating modes

- Synthesized frequency sweep (start/stop), (center/span), (swept CW)
- Power (amplitude) sweep (start/stop)
- Manual sweep
- RPG control between start and stop frequencies
- Alternate sweep
- Alternates successive sweeps between current and stored states

Sweep span range

- Settable from minimum to full range

Triggering

- Auto, external, single, or GPIB

Markers

- 10 independent continuously variable frequency markers

Two-tone (master/slave) measurements

- Two PSG's can synchronously track each other, with independent control of start/stop frequencies

Network analyzer compatibility

- Fully compatible with Agilent 8757D scalar network analyzer
- Also useable with Agilent 8757A/C/E scalar network analyzers for making basic swept measurements

Output

Power (dBm)

Minimum power (dBm)

- Standard: -20 dBm
- Option 1E1 step attenuator:
 - Options 520, 521, 532 and 540: -135 dBm
 - Options 550 and 567: -110 dBm

Maximum power (dBm) spec (typ)

Option 520	Standard	Options 1E1 + 1EU
250 kHz to 10 MHz	+12	+12 (+15)
10 to < 60 MHz	+14	+14 (+17)
60 to 250 MHz	+15	+19 (+20)
> 0.25 to 3.2 GHz	+15	+21 (+23)
> 3.2 to 10 GHz	+15	+21 (+22)
> 10 to 20 GHz	+15	+19 (+21)

Option 521	Standard	Option 1E1
10 to 250 MHz	+19 (+21)	+19 (+21)
> 0.25 to 1 GHz	+24 (+26)	+24 (+26)
> 1 to 6 GHz	+28 (+30)	+28 (+30)
> 6 to 14 GHz	+28 (+30)	+27 (+28)
> 14 to 17.5 GHz	+26 (+28)	+25 (+27)
> 17.5 to 20 GHz	+24 (+27)	+23 (+26)

E8257D

Options 532 and 540	Standard	Options 1E1 + 1EU
250 kHz to 10 MHz	+11	+11 (+14)
10 to < 60 MHz	+11	+13 (+16)
60 to 250 MHz	+11	+18 (+19)
> 0.25 to 3.2 GHz	+11	+20 (+22)
> 3.2 to 17 GHz	+11	+17 (+20)
> 17 to 37 GHz	+11	+14 (+17)
> 37 to 40 GHz	+11	+12 (+16)

Options 550 and 567	Standard	Options 1E1 + 1EU
250 kHz to 10 MHz	+5	+10 (+13)
10 to < 60 MHz	+5	+12 (+15)
60 to 250 MHz	+5	+17 (+18)
> 0.25 to 3.2 GHz	+5	+19 (+22)
> 3.2 to 10 GHz	+5	+13 (+20)
> 10 to 20 GHz	+5	+13 (+16)
> 20 to 30 GHz	+5	+9 (+16)
> 30 to 65 GHz	+5	+9 (+12)
> 65 to 67 GHz	+5	+8 (+12)
> 67 to 70 GHz	(+5)	(+6)

Step attenuator (Option 1E1)

- Options 520 and 540: 0 dB and 5 to 115 dB in 10 dB steps
- Options 550 and 567: 0 dB and 90 dB in 10 dB steps

Attenuator hold range minimum (same as max power sweep range)

- From -20 dBm to maximum specified output power with step attenuator in 0 dB position. Can be offset using Option 1E1 attenuator

Amplitude switching speed

- CW or analog modulation: < 3 ms (typical) (without power search)

Level accuracy

Level accuracy with step attenuator (Option 1E1) (dB)

Frequency	> 20 dBm	20 to 16 dBm	16 to 10 dBm	10 to 0 dBm	0 to -10 dBm	-10 to -70 dBm	-70 to -90 dBm
Options 520, 532, 540, 550, 567							
250 kHz to 2 GHz	±1.0	±0.8	±0.6	±0.6	±0.6	±0.7	±0.8
> 2 to 20 GHz	±1.0	±0.8	±0.8	±0.8	±0.8	±0.9	±1.0
> 20 to 40 GHz	—	±1.0	±1.0	±0.9	±0.9	±1.0	±2.0
> 40 to 50 GHz	—	—	—	±1.3	±0.9	±1.5	±2.5
> 50 to 67 GHz	—	—	—	±1.5	±1.0	±1.5 (typ)±2.5 (typ)	—

Option 521

10 to < 500 MHz	—	±1.3	±0.8	±0.8	±0.7	±1.0	±1.0
500 MHz to 20 GHz	±1.0	±0.8	±0.8	±0.8	±0.8	±1.1	±1.1

Resolution

- 0.01 dB

Temperature stability

- 0.01 dB/°C (typical)

User flatness correction

- Number of points: 2 to 1601 points/table
- Number of tables: up to 10,000, memory limited

Output impedance

- 50 Ω (nominal)

SWR (internally leveled) (typical)

- 250 kHz to 2 GHz < 1.4:1
- > 2 to 20 GHz < 1.6:1
- > 20 to 40 GHz < 1.8:1
- > 40 to 67 GHz < 2.0:1

Leveling modes

- Internal leveling, external detector leveling, millimeter source module, ALC off

External detector leveling

- Range: -0.2 mV to -0.5 V (nominal) (-36 to +4 dBm using Agilent 33330D/E detector)
- Bandwidth: 10 kHz (typical) (Note: not intended for pulsed operation)

Maximum reverse power

- 1/2 Watt (0V DC) (nominal)

Spectral purity

Harmonics (dBc at +10 dBm or maximum specified output power, whichever is lower)

Frequency	Options 520, 532, 540, 550, 567	Option 521
< 1 MHz	-25 (typ)	—
1 to 10 MHz	-25	—
10 to 50 MHz	-28	-25
10 to 50 MHz with Opt 1EH filters on	-45	-35
0.05 to 2 GHz	-30	-25
0.05 to 2 GHz with Opt 1EH filters on	-55	-35
2 to 20 GHz	-55	-35
20 to 67 GHz	-50 (typ)	—

SSB phase noise (CW), 20 kHz offset from carrier (dBc/Hz)

Frequency	Spec (typ)
250 kHz to 250 MHz	-130 (-134)
> 250 to 500 MHz	-134 (-138)
> 500 MHz to 1 GHz	-130 (-134)
> 1 to 2 GHz	-124 (-128)
> 2 to 3.2 GHz	-120 (-124)
> 3.2 to 9 GHz	-110 (-113)

Option UNX, offset from carrier (dBc/Hz)

Frequency	100 Hz spec (typ)	1 kHz spec (typ)	10 kHz spec (typ)	100 kHz spec (typ)
10 MHz (low noise mode)	-130 (-135)	-143 (-148)	-155 (-158)	-155 (-158)
100 MHz (low noise mode)	-119 (-124)	-130 (-135)	-140 (-145)	-140 (-145)
> 250 to 500 MHz	-108 (-118)	-126 (-132)	-132 (-136)	-136 (-141)
> 500 MHz to 1 GHz	-101 (-111)	-121 (-130)	-130 (-134)	-130 (-135)
> 1 to 2 GHz	-96 (-106)	-115 (-124)	-124 (-129)	-124 (-129)
> 2 to 3.2 GHz	-92 (-102)	-111 (-120)	-120 (-124)	-120 (-124)
> 3.2 to 9 GHz	-81 (-92)	-101 (-109)	-110 (-114)	-110 (-115)

Option UNY, offset from carrier (dBc/Hz)

Frequency	100 Hz spec (typ)	1 kHz spec (typ)	10 kHz spec (typ)	100 kHz spec (typ)
10 MHz (low noise mode)	-142 (-145)	-152 (-155)	-158 (-161)	-158 (-161)
100 MHz (low noise mode)	-122 (-124)	-140 (-142)	-145 (-147)	-145 (-147)
> 250 to 500 MHz	-108 (-118)	-126 (-132)	-144 (-148)	-146 (-151)
> 500 MHz to 1 GHz	-101 (-111)	-121 (-130)	-143 (-146)	-140 (-145)
> 1 to 2 GHz	-96 (-106)	-115 (-124)	-136 (-141)	-134 (-139)
> 2 to 3.2 GHz	-92 (-102)	-111 (-120)	-132 (-136)	-130 (-134)
> 3.2 to 9 GHz	-81 (-92)	-101 (-109)	-122 (-126)	-120 (-125)

Residual FM

- CW mode: < N x 6 Hz (typical)
- Option UNX: < N x 4 Hz (typical)
- Ramp sweep mode: < N x 1 kHz (typical)

Broadband noise (CW mode at +10 dBm output, for offsets > 10 MHz)

- > 2.4 to 20 GHz: < -148 dBc/Hz (typical)
- > 20 to 40 GHz: < -141 dBc/Hz (typical)
- > 40 GHz: < -135 dBc/Hz (typical)

Option UNT

- AM, FM, phase modulation, and LF output

Frequency modulation

Maximum deviation

- N x 16 MHz

Modulation frequency response

Path	Rates (at 100 kHz deviation)	
	1 dB bandwidth	3 dB bandwidth (typical)
FM 1	DC to 100 kHz	DC to 10 MHz
FM 2	DC to 100 kHz	DC to 1 MHz

Phase modulation

Maximum deviation

- N x 160 radians (N x 16 radians in high-bandwidth mode)

Modulation frequency response

Mode	Rates (3 dB BW)
Normal BW	DC to 100 kHz
High BW	DC to 1 MHz (typical)

Amplitude modulation ($f_c > 2$ MHz) (typical)

Depth	Linear mode	Exponential (log) mode (downward modulation only)
Maximum	> 90%	> 20 dB
Settable	0 to 100%	0 to 40 dB
Resolution	0.1%	0.01 dB
Accuracy (1 kHz rate)	< $\pm(6\%$ of setting + 1%)	< $\pm(2\%$ of setting + 0.2 dB)

Rates (3 dB bandwidth, 30% depth)

- DC/10 Hz to 100 kHz (typical) (useable to 1 MHz)

External modulation inputs (Ext1 & Ext2)

Modulation types

- AM, FM, and Φ M

Input impedance

- 50 or 600 Ω (nominal) switched

Simultaneous modulation

All modulation types may be simultaneously enabled except: FM with Φ M, and linear AM with exponential AM. AM, Φ M, and FM can sum simultaneous inputs from any two sources (Ext1, Ext2, internal1, or internal2). Any given source (Ext1, Ext2, internal1, or internal2) may be routed to only one activated modulation type.

Internal modulation source

Dual function generators provides two independent signals (internal1 and internal2) for use with AM, FM, Φ M, or LF out.

Waveforms

- Sine, square, positive ramp, negative ramp, triangle, Gaussian noise, uniform noise, swept sine, dual sine²¹

Rate range

- Sine: 0.5 Hz to 1 MHz
- Square, ramp, triangle: 0.5 Hz to 100 kHz
- Resolution: 0.5 Hz

LF out

- Output : internal1 or internal2. Also provides monitoring of internal1 or internal2 when used for AM, FM, or Φ M
- Amplitude: 0 to 3 V_{peak} (nominal) into 50 Ω
- Output impedance: 50 Ω (nominal)

Swept sine mode: (frequency, phase continuous)

- Operating modes: triggered or continuous sweeps
- Frequency range: 1 Hz to 1 MHz
- Sweep rate: 0.5 to 100,000 Hz sweeps/s, equivalent to sweep times 10 μ s to 2 s
- Resolution: 0.5 Hz (0.5 sweep/s)

Pulse modulation (Option UNU)

		500 MHz to 3.2 GHz	Above 3.2 GHz
On/off ratio		80 dB (typ)	80 dB
Rise/fall times (Tr, Tf)		100 ns (typ)	6 ns (typ)
Minimum pulse width	Internally leveled	2 μ s	1 μ s
	Level hold (ALC off with power search)	0.5 μ s	0.15 μ s
Repetition frequency	Internally leveled	10 Hz to 250 kHz	10 Hz to 500 kHz
	Level hold (ALC off with power search)	DC to 1 MHz	DC to 3 MHz

Narrow pulse modulation (Option UNW)

		10 MHz to 3.2 GHz	Above 3.2 GHz
On/off ratio		80 dB	80 dB
Rise/fall times (Tr, Tf)		10 μ s (8 ns typical)	10 μ s (6 ns typical)
Minimum pulse width	Internally leveled	1 μ s	1 μ s
	Level hold (ALC off with power search)	20 ns	20 ns
Repetition frequency	Internally leveled	10 Hz to 500 kHz	10 Hz to 500 kHz
	Level hold (ALC off with power search)	DC to 5 MHz	DC to 10 MHz

Internal pulse generator

Modes

- Free-run, triggered, triggered with delay, doublet, and gated. Triggered with delay, doublet, and gated require external trigger source

Period (PRI) (Tp)

- 70 ns to 42 s (repetition frequency: 0.024 Hz to 14.28 MHz)

Pulse width (Tw)

- 10 ns to 42 s

Delay (Td)

- Free-run mode: 0 to ± 42 s
- Triggered with delay and doublet modes: 75 ns to 42 s with ± 10 ns jitter

Resolution

- 10 ns (width, delay, and PRI)

General

Power requirements

- 100 to 120 VAC, 50 to 60 Hz; or 220 to 240 VAC, 50 to 60 Hz (automatically selected), < 250 W typical, 450 W maximum

Operating temperature range

- 0 to 55 $^{\circ}$ C

Storage temperature range

- -40 to 70 $^{\circ}$ C

Compatibility

- OML Inc. – AG Series mm-wave source modules
- Agilent Technologies 83550 Series millimeter heads
- Agilent Technologies 8757D scalar network analyzers
- Gigatronics 8003 scalar network analyzers
- Agilent Technologies EPM Series power meters

Weight

- < 22 kg (48 lb.) net, < 30 kg (68 lb.) shipping

Dimensions

- 178 mm (H) x 426 mm (W) x 515 mm (D) (7 in x 16.8 in x 20.3 in)

Ordering Information

E8257D PSG microwave analog signal generator

Frequency range (required option)

- E8257D-520 250 kHz to 20 GHz
- E8257D-521 10 MHz to 20 GHz
- E8257D-532 250 kHz to 31.8 GHz
- E8257D-540 250 kHz to 40 GHz
- E8257D-550 250 kHz to 50 GHz
- E8257D-567 250 kHz to 67 GHz

Performance enhancements

- E8257D-1E1 step attenuator
- E8257D-1EU high output power
- E8257D-1EH improved harmonics below 2 GHz (low-pass filters)
- E8257D-UNT AM, FM, Phase Modulation and LF output
- E8257D-UNU pulse modulation
- E8257D-UNW narrow pulse modulation
- E8257D-1SM scan modulation
- E8257D-007 analog ramp sweep and scalar network analyzer interface
- E8257D-008 8 GB removable flash memory
- E8257D-UNX ultra-low phase noise
- E8257D-UNY enhanced ultra-low phase noise

Manuals and accessories

- E8257D-1ED type-N (f) RF output connector (Options 520 and 521 only)
- E8257D-1EM moves all connectors to rear panel

Web Link

www.agilent.com/find/psg

SxxMS-AG

- 50 to 500 GHz frequency range
- High output power
- Driven by Agilent PSG signal generators
- Place the source module up to one meter from the generator
- Low entry cost

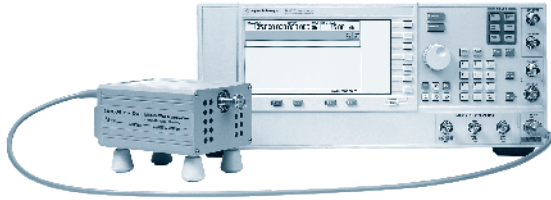

SxxMS-AG OML Inc. Millimeter-Wave Modules

The eight Oleson Microwave Labs, Inc. (OML) millimeter-wave source modules provide a simple approach to extend the frequency range of a 20 GHz Agilent PSG signal generator to cover frequencies in bands from 50 to 500 GHz. The OML source modules offer high power and the excellent frequency accuracy and resolution of the driving PSG signal generator.

High Accuracy and Resolution

The OML, Inc. millimeter wave source modules use frequency multiplication to generate millimeter wave frequency, thus the millimeter wave frequency specifications are directly proportional to those of the

microwave source driving the source modules. Since the frequency resolution of Agilent synthesizer is 0.001 Hz and the frequency multiplication factor of WR-05 is 12, thus the frequency resolution of the source module across the WR-05 band (140 – 220 GHz) is 0.012 Hz.

Spectral Purity

The OML millimeter wave source modules offer harmonic and sub-harmonic suppression of typically 20 dB in any band. The high stability and low phase noise performance of the Agilent PSG signal generator are available at millimeter wave frequencies after offsetting it by the factor of 20 log N (where N is the multiplier of the module).

High Output Power

The millimeter wave source module can be used as a local oscillator (LO) in mixer measurements providing additional dynamic range for insertion losses/gain measurements (8 dBm to 75 GHz and 5 dBm to 110 GHz). The output power is flat across the waveguide band. The output power can be varied using any of three methods: 1) fixed attenuator, 2) mechanical variable attenuator, and 3) electronic variable attenuator system.

Low Cost

The OML millimeter-wave source modules combine performance and quality with a low cost of entry to higher frequency applications. This is possible since the source modules are compatible with the PSG signal generator you may already own. The PSG models supported are the E8257D, E8267D, E8247C, E8257C and the E8267C. If you do not already own a PSG, the cost is quite low considering the superior performance and reliability of the signal generator.

Specifications¹

OML model	S15MS-AG	S12MS-AG	S10MS-AG	S08MS-AG	S06MS-AG	S05MS-AG	S03MS-AG	S02MS-AG
Frequency in (GHz)	12.5 to 18.7	10.0 to 15.0	12.5 to 18.4	11.2 to 17.5	9.1 to 14.1	11.6 to 18.4	12.2 to 18.1	10.8 to 16.7
Frequency out (GHz)	50.0 to 75.0	60.0 to 90.0	75.0 to 110.0	90.0 to 140.0	110.0 to 170.0	140.0 to 220.0	220.0 to 325.0	325.0 to 500.0
RF in (dBm)	Supplied by E82x7C/D PSG with Option 1EA (High power)							
RF in, damage level (dBm)	+36	+36	+36	+36	+36	+36	+36	+36
RF out (dBm) Typ. ²	+8	+6	+5	-2	-6	-12	-25	-35
Harmonics & sub-harmonics (dBc) Typ. ³	≤ -20	≤ -20	≤ -20	≤ -20	≤ -20	≤ -20	≤ -20	≤ -20
In-band spurious (dBc) Typ. ⁴	≤ -20	≤ -20	≤ -20	≤ -20	≤ -20	≤ -20	≤ -20	≤ -20
RF in VSWR	≤ 2.0	≤ 2.0	≤ 2.0	≤ 2.0	≤ 2.0	≤ 2.0	≤ 2.0	≤ 2.0
RF out VSWR	≤ 1.7	≤ 1.7	≤ 1.7	≤ 1.7	≤ 1.7	≤ 1.7	≤ 3.0	≤ 3.0
RF in port	SMA female	SMA female	SMA female	SMA female	SMA female	SMA female	SMA female	SMA female
RF out port ⁵	WR-15	WR-12	WR-10	WR-08	WR-06	WR-05	WR-03	WR-02.2
Power	Supplied by E82x7C/D PSG (+8 VDC @1.2 A max, +15 VDC @150 mA max)							
Temperature	+20 to +30 °C							
Weight	1.13 kg (2.5 lbs) typical							
Size ⁶	71 mm (H) x 109 mm (W) x 145 mm (D) (2.8 in x 4.3 in x 5.7 in)							

Accessories

- Standard accessories**
- 2 m DC power cable
 - 1 m RF cable SMA(m) to SMA(m)

Ordering Information⁷

- OML order information**
- S15MS-AG** WR-15 source module
 - S12MS-AG** WR-12 source module
 - S10MS-AG** WR-10 source module
 - S08MS-AG** WR-08 source module
 - S06MS-AG** WR-06 source module
 - S05MS-AG** WR-05 source module
 - S03MS-AG** WR-03 source module
 - S02MS-AG** WR-02 source module

- Agilent order information**
- E8257D-S15** WR-15 source module
 - E8257D-S12** WR-12 source module
 - E8257D-S10** WR-10 source module

- E8257D-S08** WR-08 source module
- E8257D-S06** WR-06 source module
- E8257D-S05** WR-05 source module
- E8257D-S03** WR-03 source module
- E8257D-S02** WR-02 source module

¹ Specifications subject to change without notice
² Not traceable to NIST above 110 GHz
³ As relates to the desired output frequencies
⁴ In-band mixing products. Typically ≤ -15 dBc in the lower 10% of the WR-15, WR-12 or WR10 waveguide band
⁵ RF output port flange configuration per MIL-F-3922-67B-xx
⁶ Height excludes the adjustable rubber feet length and depth dimension excludes the output waveguide length
⁷ Each source module ordered includes one each of the standard accessories listed below (2 m DC power cable and 1 m RF cable)

Web Link

www.agilent.com/find/psg
www.omlinc.com

- High output power
- Excellent phase noise performance
- 100 kHz to 9 GHz frequency coverage



E8663D PSG RF Analog Signal Generator

LO Substitution and Component Test Applications

- High output power
- Enhanced ultra-low phase noise
- Superior level accuracy
- Code compatibility with other Agilent microwave signal generators

Advanced Communication Testing of Receiver Quality, Transmitter Sensitivity and Selectivity

- Flexible analog modulation formats: AM, FM, Φ M and pulse
- Internal modulation with sine, square, triangular, ramp, and noise waveforms
- Narrow pulse modulation (20 ns) down to 10 MHz

Specifications

Frequency

Range

- Option 503: 100 kHz to 3.2 GHz
- Option 509: 100 kHz to 9 GHz

Resolution

- CW: 0.001 Hz
- All sweep modes: 0.01 Hz

Switching speed

- < 10 ms (typical)

Frequency bands

Band	Frequency range	N
1	100 kHz to 250 MHz	1/8
2	> 250 to 500 MHz	1/16
3	> 500 MHz to 1 GHz	1/8
4	> 1 to 2 GHz	1/4
5	> 2 to 3.2 GHz	1/2
6	> 3.2 to 9 GHz	1

Internal timebase reference oscillator

- Aging rate: $< \pm 3 \times 10^{-8}$ /year or $< \pm 2.5 \times 10^{-10}$ /day after 30 days

Temperature effects (typical)

- $< \pm 4.5 \times 10^{-9}$ 0 to 55 °C

Line voltage effects (typical)

- $< \pm 2 \times 10^{-10}$ for $\pm 10\%$ change

External reference frequency

- 10 MHz only (within 1 ppm)

Step (digital) sweep

Operating modes

- Step sweep of frequency or amplitude or both (start to stop)
- List sweep of frequency or amplitude or both (arbitrary list)

Sweep range

- Frequency sweep: within instrument frequency range
- Amplitude sweep: within attenuator hold range

Dwell time 1 ms to 60 s

- Frequency settling time: 28 ms (typical)
- Amplitude settling time: 10 ms (typical)

Number of points

- Step sweep: 2 to 65535
- List sweep: 2 to 1601 per table

Triggering

- Auto, external, single, or GPIB

Ramp (analog) sweep (Option 007)

Operating modes

- Synthesized frequency sweep (start/stop), (center/span), (swept CW)
- Power (amplitude) sweep (start/stop)
- Manual sweep
- RPG control between start and stop frequencies
- Alternate sweep
- Alternate successive sweeps between current and stored states

Sweep span range

- Settable from minimum to full range

Output

Minimum power (dBm)

- Standard: -20
- Option 1E1: -135

Maximum power (dBm)

Frequency range	Standard	Option 1E1 + 1EU
100 to 250 kHz	+10 (nom)	+10 (nom)
250 kHz to 10 MHz	+12	+12 (+15)
10 to < 60 MHz	+14	+14 (+17)
60 to 250 MHz	+15	+19 (+20)
> 0.25 to 3.2 GHz	+15	+21 (+23)
> 3.2 to 9 GHz	+15	+21 (+22)

Step attenuator

- (Option 1E1): 0 dB and 5 to 115 dB in 10 dB steps

Amplitude switching speed

- CW or analog modulation: < 3 ms (typical) (without power search)

Level accuracy (dB)

Frequency	> +10 dBm	+10 to 0 dBm	0 to -10 dBm	-10 to -70 dBm	-70 to -90 dBm
100 kHz to 250 kHz	± 0.6 (nom)	± 0.6 (nom)	± 0.6 (nom)	± 0.7 (nom)	± 0.8 (nom)
250 kHz to 2 GHz	± 0.6	± 0.6	± 0.6	± 0.7	± 0.8
> 2 to 9 GHz	± 0.8	± 0.8	± 0.8	± 0.9	± 1.0

Resolution

- 0.01 dB

Output impedance

- 50 Ω (nominal)

SWR (internally leveled) (typical)

- 250 kHz to 2 GHz < 1.4:1
- > 2 to 9 GHz < 1.6:1

Leveling modes

- Internal leveling, external detector leveling, ALC off

Maximum reverse power

- 1/2 Watt (0V DC) (nominal)

Spectral purity

Harmonics (dBc at +10 dBm or maximum specified output power, whichever is lower)

< 10 MHz	-25
10 to 50 MHz	-28
10 to 50 MHz with Option 1EH filters on	-45
0.05 to 2 GHz	-30
0.05 to 2 GHz with Option 1EH filters on	-45
2 to 9 GHz	-55

SSB phase noise (CW), 20 kHz offset from carrier (dBc/Hz)

Frequency	Spec (typical)
250 kHz to 250 MHz	-130 (-134)
> 250 to 500 MHz	-134 (-138)
> 500 MHz to 1 GHz	-130 (-134)
> 1 to 2 GHz	-124 (-128)
> 2 to 3.2 GHz	-120 (-124)
> 3.2 to 9 GHz	-110 (-113)

E8663D

Option UNX, offset from carrier (dBc/Hz)

Frequency	100 Hz spec (typ)	1 kHz spec (typ)	10 kHz spec (typ)	100 kHz spec (typ)
10 MHz (low noise mode)	-130 (-135)	-143 (-148)	-155 (-158)	-155 (-158)
100 MHz (low noise mode)	-119 (-124)	-130 (-135)	-140 (-145)	-140 (-145)
> 250 to 500 MHz	-108 (-118)	-126 (-132)	-132 (-136)	-136 (-141)
> 500 MHz to 1 GHz	-101 (-111)	-121 (-130)	-130 (-134)	-130 (-135)
> 1 to 2 GHz	-96 (-106)	-115 (-124)	-124 (-129)	-124 (-129)
> 2 to 3.2 GHz	-92 (-102)	-111 (-120)	-120 (-124)	-120 (-124)
> 3.2 to 9 GHz	-81 (-92)	-101 (-109)	-110 (-114)	-110 (-115)

Option UNY, offset from carrier (dBc/Hz)

Frequency	100 Hz spec (typ)	1 kHz spec (typ)	10 kHz spec (typ)	100 kHz spec (typ)
10 MHz (low noise mode)	-142 (-145)	-152 (-155)	-158 (-161)	-158 (-161)
100 MHz (low noise mode)	-122 (-124)	-140 (-142)	-145 (-147)	-145 (-147)
> 250 to 500 MHz	-108 (-118)	-126 (-132)	-144 (-148)	-146 (-151)
> 500 MHz to 1 GHz	-101 (-111)	-121 (-130)	-143 (-146)	-140 (-145)
> 1 to 2 GHz	-96 (-106)	-115 (-124)	-136 (-141)	-134 (-139)
> 2 to 3.2 GHz	-92 (-102)	-111 (-120)	-132 (-136)	-130 (-134)
> 3.2 to 9 GHz	-81 (-92)	-101 (-109)	-122 (-126)	-120 (-125)

Broadband Noise (CW mode at +10 dBm output, for offsets > 10 MHz)
 • > 2.4 to 9 GHz: < -148 dBc/Hz (typical)

Frequency modulation

Maximum deviation

- N x 16 MHz

Modulation frequency response

Path	Rates (at 100 kHz deviation) 1 dB bandwidth	3 dB bandwidth (typical)
FM 1	DC to 100 kHz	DC to 10 MHz
FM 2	DC to 100 kHz	DC to 1 MHz

Phase modulation

Maximum deviation

- N x 160 radians (N x 16 radians in high-bandwidth mode)

Modulation frequency response

Mode	Rates (3 dB BW)
Normal BW	DC to 100 kHz
High BW	DC to 1 MHz (typical)

Amplitude modulation ($f_c > 2$ MHz) (typical)

Depth	Linear mode	Exponential (log) mode (downward modulation only)
Maximum	> 90%	> 20 dB
Settable	0 to 100%	0 to 40 dB
Resolution	0.1%	0.01 dB
Accuracy (1 kHz rate)	< ±(6% of setting + 1%)	< ±(2% of setting + 0.2 dB)

Rates (3 dB bandwidth, 30% depth)
 • DC/10 Hz to 100 kHz (typical) (useable to 1 MHz)

External modulation inputs (Ext1 and Ext2)

Modulation types

- AM, FM, and ΦM

Input impedance

- 50 or 600 Ω (nominal) switched

Simultaneous modulation

All modulation types may be simultaneously enabled except: FM with ΦM, and linear AM with exponential AM. AM, ΦM, and FM can sum simultaneous inputs from any two sources (Ext1, Ext2, internal1, or internal2). Any given source (Ext1, Ext2, internal1, or internal2) may be routed to only one activated modulation type.

Internal modulation source

Dual function generators provides two independent signals (internal1 and internal2) for use with AM, FM, ΦM, or LF out.

Waveforms

Sine, square, positive ramp, negative ramp, triangle, Gaussian noise, uniform noise, swept sine, dual sine²¹

Pulse modulation

	500 MHz to 3.2 GHz	Above 3.2 GHz
On/off ratio	80 dB (typ)	80 dB
Rise/fall times (Tr, Tf)	100 ns (typ)	6 ns (typ)
Minimum pulse width	Internally leveled	2 μs
	Level hold (ALC off with power search)	0.5 μs
Repetition frequency	Internally leveled	10 Hz to 250 kHz
	Level hold (ALC off with power search)	DC to 1 MHz

Narrow pulse modulation (Option UNW)

	10 MHz to 3.2 GHz	Above 3.2 GHz
On/off ratio	80 dB	80 dB
Rise/fall times (Tr, Tf)	10 μs (8 ns typical)	10 μs (6 ns typical)
Minimum pulse width	Internally leveled	1 μs
	Level hold (ALC off with power search)	20 ns
Repetition frequency	Internally leveled	10 Hz to 500 kHz
	Level hold (ALC off with power search)	DC to 5 MHz

Internal pulse generator

Modes

- Free-run, triggered, triggered with delay, doublet, and gated. Triggered with delay, doublet, and gated require external trigger source

Period (PRI) (Tp)

- 70 ns to 42 s (repetition frequency: 0.024 Hz to 14.28 MHz)

Pulse width (Tw)

- 10 ns to 42 s

Resolution

- 10 ns (width, delay, and PRI)

General

Power requirements

- 100 to 120 VAC, 50 to 60 Hz; or 220 to 240 VAC, 50 to 60 Hz (automatically selected), < 250 W typical, 450 W maximum

Operating temperature range

- 0 to 55 °C

Storage temperature range

- -40 to 70 °C

Weight

- < 22 kg (48 lb.) net, < 30 kg (68 lb.) shipping

Dimensions

- 178 mm (H) x 426 mm (W) x 515 mm (D) (7 in x 16.8 in x 20.3 in)

Ordering Information

E8663D PSG RF analog signal generator

Frequency range (required option)

- E8663D-503** 100 kHz to 3.2 GHz
- E8663D-509** 100 kHz to 9 GHz

Performance enhancements

- E8663D-1E1** step attenuator
- E8663D-1EU** high output power
- E8663D-1EH** improved harmonics below 2 GHz (low-pass filters)
- E8663D-UNT** AM, FM, phase modulation and LF output
- E8663D-UNW** narrow pulse modulation
- E8663D-1SM** scan modulation
- E8663D-007** analog ramp sweep and scalar network analyzer interface
- E8663D-008** 8 GB removable flash memory
- E8663D-UNX** ultra-low phase noise
- E8663D-UNY** enhanced ultra-low phase noise

Web Link

www.agilent.com/find/E8663D

- Frequency range from 250 kHz to 3 or 6 GHz
- Excellent spectral purity
- Standard high-stability time base
- Built-in low frequency function generator



E4428C ESG RF analog signal generator

Excellent All-Inclusive RF and Analog Modulation Performance up to 3 or 6 GHz

The E4428C ESG analog signal generator delivers outstanding spectral purity, level accuracy, output power, and analog modulation performance up to 3 or 6 GHz for all general-purpose test needs. This makes the E4428C ESG a superb choice for general-purpose tests requiring CW, pulse, AM, Φ M, and FM receiver and component test signals in the cellular, ISM, and UNII frequency bands.

Low Single-Sideband Phase Noise Performance

Single-sideband (SSB) phase noise is an extremely important specification for a signal generator. For example, if used for measuring the adjacent channel selectivity of a receiver, test results might indicate a failure when the receiver is actually functioning properly if the phase noise of the signal generator is too high. With a typical SSB phase noise performance of -134 dBc/Hz at 20 kHz offset from a 1 GHz carrier, the E4428C ESG will meet your demanding performance needs. Other key applications that require high spectral purity include LO substitution, low-jitter clock stimulus, blocking/interference signals, and in-channel measurements close to the carrier.

Specifications for Frequency and Power Characteristics

Frequency

Frequency range

- Option 503: 250 kHz to 3 GHz (electronic attenuator standard)
- Option 506: 250 kHz to 6 GHz (mechanical attenuator only)

Frequency switching speed¹

Option 503		Option 506	
Freq. ²	Freq./Amp. ³	Freq. ²	Freq./Amp. ³
(< 9 ms)	(< 9 ms)	(< 16 ms)	(< 17 ms)
[For hops < 5 MHz within a band]			
(< 9 ms)	(< 9 ms)	(< 12 ms)	(< 14 ms)

Internal reference oscillator

Stability¹

Standard	
Aging rate	< ± 0.1 ppm/yr or < ± 0.0005 ppm/day after 45 days

RF reference input requirements

Standard	
Frequency	1, 2, 5, 10 MHz ± 0.2 ppm

Output power

Power

	Option 503	Option UNB	Option 506
250 kHz to 250 MHz	+11 to -136 dBm	+15 to -136 dBm	+12 to -136 dBm
> 250 MHz to 1 GHz	+13 to -136 dBm	+17 to -136 dBm	+14 to -136 dBm
> 1 to 3 GHz	+10 to -136 dBm	+16 to -136 dBm	+13 to -136 dBm
> 3 to 6 GHz	—	—	+10 to -136 dBm

Level accuracy

With Option 506^{4,5}

Power level	+7 to -50 dBm	-50 to -110 dBm	-110 to -127 dBm	< -127 dBm
250 kHz to 2 GHz	± 0.6	± 0.8	± 0.8	(± 1.5)
2 to 3 GHz	± 0.6	± 0.8	± 1.0	(± 2.5)
3 to 4 GHz	± 0.8	± 0.9	± 1.5	(± 2.5)
4 to 6 GHz	± 0.8	± 0.9	(± 1.5)	

Level switching speed⁴

	Option 503	Option UNB	Option 506
Normal operation (ALC on)	(< 15 ms)	(< 21 ms)	(< 21 ms)
When using power search manual	(< 83 ms)	(< 95 ms)	(< 95 ms)
When using power search auto	(< 103 ms)	(< 119 ms)	(< 119 ms)

Spectral purity

SSB phase noise (at 20 kHz offset)⁴

	Standard
at 500 MHz	< -135 dBc/Hz, (< -138 dBc/Hz)
at 1 GHz	< -130 dBc/Hz, (< -134 dBc/Hz)
at 2 GHz	< -124 dBc/Hz, (< -128 dBc/Hz)
at 3 GHz	< -121 dBc/Hz, (< -125 dBc/Hz)
at 4 GHz	< -118 dBc/Hz, (< -122 dBc/Hz)
at 6 GHz	< -113 dBc/Hz, (< -117 dBc/Hz)

Specifications for Analog Modulation

Frequency bands

Band	Frequency range	N #
1	250 kHz to ≤ 250 MHz	1
2	> 250 MHz to ≤ 500 MHz	0.5
3	> 500 MHz to ≤ 1 GHz	1
4	> 1 to ≤ 2 GHz	2
5	> 2 to ≤ 4 GHz	4
6	> 4 to ≤ 6 GHz	8

Frequency modulation⁶

Maximum deviation⁷

- N x 1 MHz

Modulation frequency rate⁸ (deviation = 100 kHz)

Coupling	1 dB bandwidth	3 dB bandwidth
FM path 1 (DC)	DC to 100 kHz	(DC to 10 MHz)
FM path 2 (DC)	DC to 100 kHz	(DC to 0.9 MHz)
FM path 1 (AC)	20 Hz to 100 kHz	(5 Hz to 10 MHz)
FM path 2 (AC)	20 Hz to 100 kHz	(5 Hz to 0.9 MHz)

Phase modulation⁶

Modulation frequency response^{4,7}

Standard

Mode	Maximum deviation	Allowable rates (3 dB BW)	
		Φ M path 1	Φ M path 2
Normal BW	N x 10 radians	DC to 100 kHz	DC to 100 kHz
High BW	N x 1 radians	(DC to 1 MHz)	(DC to 0.9 MHz)

Amplitude modulation^{6,9} ($f_c > 500$ kHz)

Range

- 0 to 100%

Rates (3 dB bandwidth)

- DC coupled: 0 to 10 kHz
- AC coupled: 10 Hz to 10 kHz

Pulse modulation

On/off ratio⁴

- < 4 GHz > 80 dB
- ≤ 4 GHz (> 64 dB)

Rise/fall times⁴

- (150 ns)

E4428C

Minimum width⁴

- ALC on (2 μ s)
- ALC off (0.4 μ s)

Pulse repetition frequency⁴

- ALC on (10 Hz to 250 kHz)
- ALC off (DC to 1.0 MHz)

Internal pulse generator

- Square wave rate: 0.1 Hz to 20 kHz
- Pulse
 - Period: 8 μ s to 30 seconds
 - Width: 4 μ s to 30 seconds
 - Resolution: 2 μ s

Internal analog modulation source

(Provides FM, AM, pulse, and phase modulation signals and LF audio out)

Waveforms

- sine, square, ramp, triangle, pulse, noise

Rate range

- Sine: 0.1 Hz to 100 kHz
- Square, ramp, triangle: 0.1 Hz to 20 kHz

Swept sine mode (frequency, phase continuous)

- Operating modes: triggered or continuous sweeps
- Frequency range: 0.1 Hz to 100 kHz
- Sweep time: 1 ms to 65 sec
- Resolution: 1 ms

Dual sinewave mode

- Frequency range: 0.1 Hz to 100 kHz
- Amplitude ratio: 0 to 100%
- Amplitude ratio resolution: 0.1%

External modulation inputs

Modulation types

- Ext 1: FM, Φ M, AM, pulse
- Ext 2: FM, Φ M, AM, and pulse

Composite modulation

AM, FM, and Φ M each consist of two modulation paths which are summed internally for composite modulation.

Simultaneous modulation

Multiple modulation types may be simultaneously enabled with some exceptions.

General Characteristics

Operating characteristics

Weight

- < 16 kg (35 lb.) net, < 23 kg (50 lb.) shipping

Dimensions

- 133 mm (H) x 426 mm (W) x 432 mm (D) (5.25 in x 16.8 in x 17 in)

Remote programming

- Interface: GPIB (IEEE-488.2-1987) with listen and talk, RS-232, LAN (10BaseT)
- Control languages⁶: SCPI version 1996.0, also compatible with 8656B and 8657A/B/C/D/J1 mnemonics

Ordering Information

E4428C analog signal generator

Frequency range

- E4428C-503** 250 kHz to 3 GHz (electronic attenuator standard)
- E4428C-506** 250 kHz to 6 GHz (mechanical attenuator only)

Performance enhancements

- E4428C-UNB** high output power with mechanical attenuator (for Option 503 models only)
- E4428C-1EM** moves all front panel connectors to rear
- E4428C-UK6** commercial calibrations certificate with test data

Manuals and accessories

- E4428C-CD1** CD-ROM of English user guide and assembly level service manual (standard with instrument)
- E4428C-ABA** printed English documentation set
- E4428C-OBW** service documentation, assembly level
- E4428C-1CM** rack mount kit without handles
- E4428C-1CP** rack mount kit with handles
- E4428C-1CN** front handle kit

¹ Parentheses denote typical performance

² To within 0.1 ppm of final frequency above 250 MHz or within 100 Hz below 250 MHz

³ Frequency switching time with the amplitude settled within ± 0.1 dB

⁴ Parentheses denote typical performance

⁵ Quoted specifications for 23 $^{\circ}$ C \pm 5 $^{\circ}$ C. Accuracy degrades by less than 0.01 dB/ $^{\circ}$ C over full temperature range. Accuracy degrades by 0.2 dB above +10 dBm, and by 0.8 dB above +13 dBm

⁶ All analog performance above 3 GHz is typical

⁷ Refer to frequency bands on this page to compute N

⁸ Bandwidth is automatically selected based on deviation

⁹ AM is typical above 3 GHz

Web Link

www.agilent.com/find/E4428C

- Frequency range from 100 kHz to 1, 3 or 6 GHz
- Fast switching speeds
- High output power
- Low cost of ownership
- FM, PM, AM and pulse modulation
- Low broadband noise



N5181A MXG RF analog signal generator

Designed for the Most Demanding Manufacturing and R&D Testing

Featuring high reliability and high power – all in two rack units (2RU) – Agilent MXG analog is optimized to provide the accurate and repeatable reference signals needed from the R&D bench to the production line. Add optional fast frequency and amplitude switching and MXG analog delivers the most value for your manufacturing investment by increasing throughput, maximizing uptime, and saving rack space. With scalable RF performance, the Agilent MXG analog is easily configured to meet your specific test needs, including LO and clock substitution, CW interferers, and modulated signals for analog communication systems such as AM, FM, and Φ M.

Fast Switching Speeds

- Increase throughput with arbitrary switching of frequency and amplitude ≤ 1.2 ms or ≤ 900 μ s in list mode

High Output Power

- Compensate for system losses or drive your device into compression with $> +23$ dBm output power

Maximize Uptime

- One of the most reliable signal generators on the market with electronic attenuation to 6 GHz
- Low cost of ownership is ensured with simplified self-maintenance for repair and performance verification, keeping downtime to less than 2 hours using field-replaceable assemblies

Low Broadband Noise

- Better characterize your ADC, Mixer, or receiver with a broadband noise floor less than -155 dBc

Specifications

Frequency range

- Option 501: 100 kHz to 1 GHz
- Option 503: 100 kHz to 3 GHz
- Option 506: 100 kHz to 6 GHz

Frequency switching speed^{1,2}

Type	Standard	Option UNZ ³	Option UNZ ³ (typical)
SCPI mode	≤ 5 ms (typ)	≤ 1.15 ms	≤ 950 μ s
List/step sweep mode	≤ 5 ms (typ)	≤ 900 μ s	≤ 700 μ s

Internal time base reference oscillator aging rate

- $\leq \pm 5$ ppm/10 yrs, $< \pm 1$ ppm/yr (nom)⁴

External reference input frequency

- Standard: 10 MHz
- Option 1ER: 1 to 50 MHz (in multiples of 0.1 Hz)

Output power⁵

- Minimum output power: -110 dBm
- With Option 1EQ⁶: -127 dBm

Maximum output power

Range	Standard ⁷	Option 1EA
100 to 250 kHz	+13 dBm	+15 dBm
> 250 kHz to 50 MHz	+13 dBm	+15 dBm
> 50 MHz to 3.0 GHz	+13 dBm	+23 dBm
> 3.0 to 5.0 GHz	+13 dBm	+17 dBm
> 5.0 GHz	+11 dBm	+16 dBm

Amplitude switching speed^{8,9}

Type	Standard	Option UNZ	Option UNZ (typical)
SCPI mode	≤ 5 ms (typ)	≤ 750 μ s	≤ 650 μ s
List/step sweep mode	≤ 5 ms (typ)	≤ 500 μ s	≤ 400 μ s

Absolute level accuracy¹⁰ [ALC on]

	Standard		Option 1EQ
	+23 ¹¹ to -60 dBm	< -60 to -110 dBm	< -110 to -127 dBm
100 kHz to 250 kHz ¹²	± 0.6 dB	± 1.0 dB	—
> 250 kHz to 1 MHz	± 0.6 dB	± 0.7 dB	± 1.7 dB
> 1 MHz to 1 GHz	± 0.6 dB	± 0.7 dB	± 1.0 dB
> 1 to 3 GHz	± 0.6 dB	± 0.8 dB	± 1.1 dB
> 3 to 4 GHz	± 0.7 dB	± 0.8 dB	± 1.1 dB
> 4 to 6 GHz	± 0.8 dB	± 1.1 dB	± 1.3 dB

Spectral purity

Single sideband phase noise [at 20 kHz offset]

- 500 MHz: ≤ -126 dBc/Hz (typ)
- 1 GHz: ≤ -121 dBc/Hz (typ)
- 2 GHz: ≤ -115 dBc/Hz (typ)
- 3 GHz: ≤ -110 dBc/Hz (typ)
- 4 GHz: ≤ -109 dBc/Hz (typ)
- 6 GHz: ≤ -104 dBc/Hz (typ)

Single sideband phase noise optimized signal-to-noise floor mode

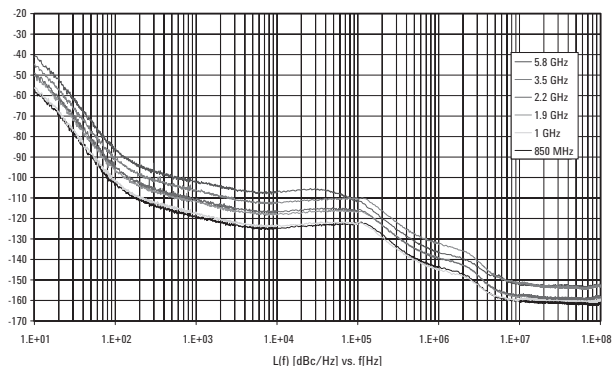

Note: Signal-to-noise optimized mode will improve broadband noise floor. In this mode, other specifications may not apply. Applies to instrument serial number prefix 4818xxxx or above

Analog modulation

Frequency bands¹

Band	Frequency range	N
1	100 kHz to < 250 MHz	1
2	250 to < 375 MHz	0.25
3	375 to < 750 MHz	0.5
4	750 to < 1500 MHz	1
5	1500 to < 3000.001 MHz	2
6	3000.001 to 6000 MHz	4

Frequency modulation¹ (Option UNT)

- Max deviation: $N \times 10$ MHz (nom)
- Modulation frequency response [at 100 kHz deviation]

	1 dB bandwidth	3 dB bandwidth
DC coupled	DC to 3 MHz (nom)	DC to 7 MHz (nom)
AC coupled	5 Hz to 3 MHz (nom)	5 Hz to 7 MHz (nom)

N5181A

Phase modulation¹² (Option UNT)

Modulation deviation and frequency response:

	Max dev	3 dB bandwidth
Normal BW	N x 5 radians (nom)	DC to 1 MHz (nom)
High BW mode	N x 0.5 radians (nom)	DC to 4 MHz (nom)

Amplitude modulation¹³ (Option UNT)

- Maximum depth: 100%
- Modulation rate [3 dB BW]
 - DC coupled: 0 to 10 kHz (typ)
 - AC coupled: 5 Hz to 10 kHz (typ)

Pulse modulation (Option UNU)¹⁴

- On/off ratio: > 80 dB (typ)
- Rise/fall time: < 50 ns (typ)
- Minimum width¹⁵: ≥ 500 ns
- Pulse repetition frequency¹⁵: DC to 2 MHz

Narrow pulse modulation (Option UNW)¹⁴

	500 MHz to 3.0 GHz	Above 3.0 GHz
On/off ratio	> 80 dB (typ)	> 80 dB (typ)
Rise/fall time	< 10 ns; 7 ns (typ)	< 10 ns; 7 ns (typ)
Minimum width¹⁵	≥ 20 ns	≥ 20 ns
Pulse repetition frequency¹⁵	DC to 5 MHz	DC to 10 MHz

Internal pulse generator (included with Option UNU or UNW)

- Modes: free-run, square, triggered, adjustable doublet, trigger doublet, gated, and external pulse
- Square wave rate: 0.1 Hz to 10 MHz, 0.1 Hz resolution (nom)
- Pulse period: 30 ns (500 ns with UNU) to 42 seconds (nom)
- Pulse width: 20 ns (500 ns with UNU) to pulse period – 10 ns (nom)
- Resolution: 10 ns (nom)

Pulse train (Option 320)

- Number of pulse patterns: 2047
- On/off time range (UNU): 500 ns to 42 sec
- On/off time range (UNW): 20 ns to 42 sec

Remote programming

- Interfaces GPIB IEEE-488.2, 1987 with listen and talk
- LAN: 100 BaseT LAN interface, LXI Class B compliant
- USB: Version 2.0
- Control languages : SCPI Version 1997.0

Compatibility languages supporting 100% of commonly used commands

- Agilent Technologies E4438C, E4428C, E442xB, E443xB, E8241A, E8244A, E8251A, E8254A, E8247C, E8257C/D, E8267C/D, 8648 Series, 8656B, E8663B, 8657A/B

Security (Option 006)

- Memory sanitizing, memory sanitizing on power on, and display blanking

Weight

- ≤ 12.5 kg (27.5 lb.) net, ≤ 27.2 kg (60 lb.) shipping

Dimensions

- 88 mm H x 426 mm W x 432 mm L (3.5 in H x 16.8 in W x 17 in L)

¹ Time from receipt of SCPI command or trigger signal to within 0.1 ppm of final frequency or within 100 Hz, whichever is greater, and amplitude settled to within 0.2 dB

² Additional time may be required for the amplitude to settle within 0.2 dB when switching to or from frequencies < 500 kHz

³ Specifications apply when status register updates are off

⁴ Aging rate is determined by design as a function of the TCXO and is not specified

⁵ Quoted specifications between 20 and 30 °C. Maximum output power typically decreases by 0.04 dB/°C for temperatures outside this range

⁶ Settable to –144 dBm with Option 1EQ, but unspecified below –127 dBm

⁷ Specifications apply to units with serial numbers ending with 4818xxxx or greater

⁸ Time from receipt of SCPI command or trigger signal to amplitude settled within 0.2 dB. For units with serial numbers ending in 4742xxxx or less, switching speed is specified for power levels < +5 dBm

⁹ Switching speed specifications apply when status register updates are off.3. Quoted specifications between 20 and 30 °C. For temperatures outside this range, absolute level accuracy degrades by 0.005 dB/°C for frequencies ≤ 4.5 GHz and 0.01 dB/°C for frequencies > 4.5 GHz. Output power may drift up to .003 dB per g/Kg change in specific humidity (nom)

¹⁰ Or maximum specified output power, whichever is lower

¹¹ Specification applies to units with serial numbers ending with 4818xxxx or greater. For units with lower serial numbers refer to the Archive Section at end of this document

¹² N is a factor used to define certain specifications in the document

¹³ AM is specified at carrier frequencies from 500 kHz to 3 GHz, power levels ≤ ±4 dBm, and with ALC on and envelope peaks within ALC operating range (–20 dBm to maximum specified power, excluding step-attenuator setting)

¹⁴ Pulse specifications apply to frequencies > 500 MHz. Operable down to 10 MHz

¹⁵ ALC off with power search

Ordering Information

Frequency

N5181A-501 frequency range from 100 kHz to 1 GHz

N5181A-503 frequency range from 100 kHz to 3 GHz

N5181A-506 frequency range from 100 kHz to 6 GHz

Performance enhancements

N5181A-UNZ fast switching

N5181A-1EA high output power

N5181A-1EQ low power (< –110 dBm)

N5181A-UNU pulse modulation

N5181A-UNW narrow pulse modulation

N5181A-320 pulse train generator

N5181A-UNT AM, FM, phase modulation

N5181A-006 instrument security

N5181A-1ER flexible reference input (1-50 MHz)

N5181A-1EM move RF output to rear panel 1

N5181A-UK6 commercial calibration certificate with test data

N5181A-099 expanded license key upgradeability

Accessories

N5181A-1CM rackmount kit

N5181A-1CN front handle kit

N5181A-1CP rackmount and front handle kit

N5181A-1CR rack slide kit

N5181A-AXT transit case

N5181A-800 customer service kit front panel connector configuration

(parts kit enables owners to repair the MXG on site, includes internal replacement parts, tools, and a calibrated RF module.)

N5181A-801 customer service kit rear panel (1EM) RF connector configuration (parts kit enables owners to repair the MXG on site, includes internal replacement parts, tools, and a calibrated RF module.)

Web Link

www.agilent.com/find/n5181a

- Frequency range from 100 kHz to 20, 31.8 or 40 GHz
- Fast switching speeds
- High output power
- Low cost of ownership
- FM, PM, AM and pulse modulation
- Low broadband noise



N5183A MXG microwave analog signal generator

Microwave Signal Generation Optimized for Manufacturing

The N5183A MXG delivers the performance you require for a wide variety of broadband measurements in a compact, 2U-high package, making it a particularly useful tool for microwave component and system manufacturing test applications, including LO substitution, traveling wave tube amplifier (TWTA) tests, and antenna measurements.

Power to Overcome System Losses

Every microwave engineer knows that as frequencies go up, so do power losses through cables, switches, filters, and other components in your test system. The MXG provides +18 dBm to 20 GHz to overcome those losses and provide adequate power to your device.

Increase Throughput

Demanding schedules require that modern test systems deliver high measurement throughput. The N5183A MXG delivers a fast, reliable stimulus with frequency switching speeds of $\leq 900 \mu\text{s}$ ($\leq 600 \mu\text{s}$ typical) and amplitude switching speeds $\leq 5 \text{ ms}$ ($\leq 2 \text{ ms}$ typical) in digital step sweep mode.

Lower Cost of Ownership

Every element of the N5183A MXG is designed to maximize uptime and reduce your cost of ownership, from a simplified design that delivers high reliability to cost- and time-effective tools for easy self-maintenance. The MXG has 100% internal diagnostic capability, and is composed of five easily replaceable, pre-calibrated assemblies that minimize any potential downtime to less than 1 working day.

Specifications

Frequency range¹

- Option 520: 100 kHz to 20 GHz
- Option 532: 100 kHz to 31.8 GHz
- Option 540: 100 kHz to 40 GHz

Frequency switching speed^{2,3}

Type	Standard	Option UNZ	Option UNZ (typical)
SCPI mode	$\leq 5 \text{ ms}$ (typ)	$\leq 1.15 \text{ ms}$	$\leq 750 \mu\text{s}$
List/step sweep mode	$\leq 5 \text{ ms}$ (typ)	$\leq 900 \mu\text{s}$	$\leq 600 \mu\text{s}$

Internal time base reference oscillator aging rate

- $< \pm 1 \text{ ppm/yr}$ (0 to 55 °C)

External reference input frequency

- Standard (fixed): 10 MHz $\pm 10 \text{ Hz}$
- Option 1ER (variable): 1 to 50 MHz (in multiples of 0.1 Hz)

Output power⁴

	Standard	Option 1E1 (step attenuator)
Minimum output power	-20 dBm	-90 dBm, settable to -130 dBm

Maximum output power

Range	Standard ⁵	Option 1EA (high output power) ⁵	
Option 520	100 kHz to 250 kHz	+11 dBm	+14 dBm
	> 250 kHz to 3.2 GHz	+11 dBm	+15 dBm
	> 3.2 GHz to 20 GHz	+11 dBm	+18 dBm
Options 532 and 540	100 kHz to 250 kHz	+11 dBm	+14 dBm
	> 250 kHz to 3.2 GHz	+7 dBm	+14 dBm
	> 3.2 GHz to 17 GHz	+7 dBm	+15 dBm
	> 17 to 31.8 GHz	+7 dBm	+13 dBm
	> 31.8 to 40 GHz	+7 dBm	+12 dBm

Amplitude switching speed^{7,8}

- SCPI mode: $\leq 2 \text{ ms}$ (typ)
- List/step sweep mode: $\leq 2 \text{ ms}$ (typ)

Absolute level accuracy (dB)⁹

Frequency range	> +10 dBm	+10 to -10 dBm	< -10 to -20 dBm
250 kHz to 2 GHz	$\pm 0.6 \text{ dB}$	$\pm 0.6 \text{ dB}$	$\pm 1.4 \text{ dB}$
> 2 to 20 GHz	$\pm 0.9 \text{ dB}$	$\pm 0.9 \text{ dB}$	$\pm 1.3 \text{ dB}$
> 20 to 40 GHz	$\pm 1.0 \text{ dB}$	$\pm 0.9 \text{ dB}$	$\pm 1.3 \text{ dB}$

Absolute level accuracy with Option 1E1 (dB)

Frequency range	> +10 dBm	+10 to -10 dBm	< -10 to -75 dBm	< -75 to -90 dBm
250 kHz to 2 GHz	$\pm 0.6 \text{ dB}$	$\pm 0.6 \text{ dB}$	$\pm 0.7 \text{ dB}$	$\pm 1.4 \text{ dB}$
> 2 to 20 GHz	$\pm 0.9 \text{ dB}$	$\pm 0.9 \text{ dB}$	$\pm 1.0 \text{ dB}$	$\pm 1.6 \text{ dB}$
> 20 to 40 GHz	$\pm 1.0 \text{ dB}$	$\pm 0.9 \text{ dB}$	$\pm 1.1 \text{ dB}$	$\pm 2.0 \text{ dB}$

Spectral purity

Harmonics (dBc)

- 250 kHz to 2 GHz: -28 (-30 typ)
- > 2 to 20 GHz: -54 (-60 typ)
- > 20 to 40 GHz: -56 (typ)

Single sideband phase noise [at 20 kHz offset]

- 500 MHz: $\leq -122 \text{ dBc/Hz}$ (typ)
- 1 GHz: $\leq -116 \text{ dBc/Hz}$ (typ)
- 2 GHz: $\leq -110 \text{ dBc/Hz}$ (typ)
- 3 GHz: $\leq -110 \text{ dBc/Hz}$ (typ)
- 5 GHz: $\leq -104 \text{ dBc/Hz}$ (typ)
- 10 GHz: $\leq -98 \text{ dBc/Hz}$ (typ)
- 20 GHz: $\leq -92 \text{ dBc/Hz}$ (typ)
- 40 GHz: $\leq -86 \text{ dBc/Hz}$ (typ)

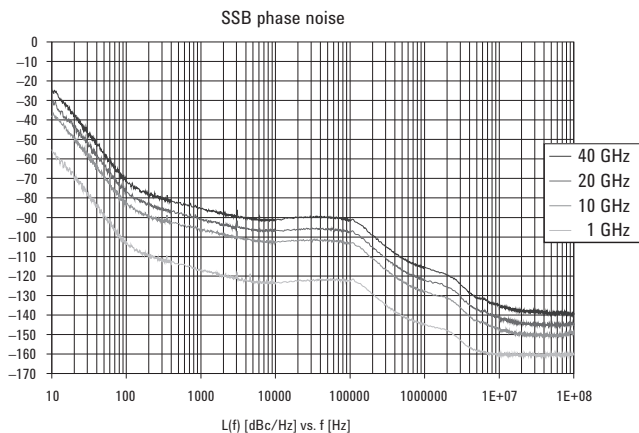

N5183A

Analog modulation

Frequency bands¹⁰

Band	Frequency range	N
1	100 kHz to < 250 MHz	1
2	250 to < 375 MHz	0.25
3	375 to < 750 MHz	0.5
4	750 to < 1500 MHz	1
5	1.5 to < 3.0 GHz	2
6	3.0 to < 6.0 GHz	4
7	6.0 to < 12.0 GHz	8
8	12.0 to < 24.0 GHz	16
9	24.0 to 40 GHz	32

Frequency modulation¹⁰ (Option UNT)

- Max deviation: N x 10 MHz (nom)

Modulation frequency response [at 100 kHz deviation]

	1 dB bandwidth	3 dB bandwidth
DC coupled	DC to 3 MHz (nom)	DC to 7 MHz (nom)
AC coupled	5 Hz to 3 MHz (nom)	5 Hz to 7 MHz (nom)

Phase modulation¹⁰ (Option UNT)

Modulation deviation and frequency response:

	Max dev	3 dB bandwidth
Normal BW	N x 5 radians (nom)	DC to 1 MHz (nom)
High BW mode	N x 0.5 radians (nom)	DC to 4 MHz (nom)

Amplitude modulation¹¹ (Option UNT)

- Maximum depth: 90%
- Modulation rate [3 dB BW, 30% depth]
 - DC coupled: 0 to 10 kHz (typ)
 - AC coupled: 5 Hz to 10 kHz (typ)

Pulse modulation (Option UNU)¹²

- On/off ratio: > 80 dB (typ)¹³
- Rise/fall time: < 50 ns (typ)
- Minimum width¹³: ≥ 500 ns
- Pulse repetition frequency¹³: DC to 2 MHz

Narrow pulse modulation (Option UNW)¹²

	500 MHz to 3.2 GHz	Above 3.2 GHz
On/off ratio	> 80 dB (typ)	> 80 dB (typ)
Rise/fall time	< 10 ns; 7 ns (typ)	< 10 ns; 7 ns (typ)
Minimum width¹⁴	≥ 20 ns	≥ 20 ns
Pulse repetition frequency¹⁴	DC to 5 MHz	DC to 10 MHz

Internal pulse generator (included with Option UNU or UNW)

- Modes: free-run, square, triggered, adjustable doublet, trigger doublet, gated, and external pulse
- Square wave rate: 0.1 Hz to 10 MHz, 0.1 Hz resolution (nom)
- Pulse period: 30 ns (500 ns with Option UNU) to 42 seconds (nom)
- Pulse width: 20 ns (500 ns with Option UNU) to pulse period – 10 ns (nom)
- Resolution: 10 ns (nom)

Pulse train (Option 320)

- Number of pulse patterns: 2047
- On/off time range (Option UNU): 500 ns to 42 sec
- On/off time range (Option UNW): 20 ns to 42 sec

Remote programming

- Interfaces GPIB IEEE-488.2, 1987 with listen and talk
- LAN: 100BaseT LAN interface, LXI Class B compliant
- USB: Version 2.0
- Control languages : SCPI Version 1997.0

Compatibility languages supporting 100% of commonly used commands

- Agilent Technologies E4438C, E4428C, E442xB, E443xB, E8241A, E8244A, E8251A, E8254A, E8247C, E8257C/D, E8267C/D, 8648 Series, 8656B, E8663B, 8657A/B

Security (Option 006)

- Memory sanitizing, memory sanitizing on power on, and display blanking

Weight

- ≤ 13.8 kg (30 lb.) net, ≤ 28.4 kg (62 lb.) shipping

Dimensions

- 88 mm H x 426 mm W x 432 mm L (3.5 in H x 16.8 in W x 17 in L)

Ordering Information

Frequency

- N5183A-520** frequency range from 100 kHz to 20 GHz
- N5183A-532** frequency range from 100 kHz to 31.8 GHz
- N5183A-540** frequency range from 100 kHz to 40 GHz

Performance enhancements

- N5183A-1E1** step attenuator
- N5183A-1EA** high output power
- N5183A-UNZ** fast frequency switching
- N5183A-UNU** pulse modulation
- N5183A-UNW** narrow pulse modulation
- N5183A-320** pulse train generator
- N5183A-UNT** AM, FM, phase modulation
- N5183A-006** instrument security
- N5183A-1ER** flexible reference input (1-50 MHz)
- N5183A-1EM** move RF output to rear panel
- N5183A-1ED** type N RF output connector (Option 520 only)
- N5183A-UK6** commercial calibration certificate with test data

Accessories

- N5183A-1CM** rackmount kit
- N5183A-1CN** front handle kit
- N5183A-1CP** rackmount and front handle kit
- N5183A-1CR** rack slide kit
- N5183A-AXT** transit case

¹ Performance below 250 is unspecified, except as indicated

² Time from receipt of SCPI command or trigger signal to within 0.1 ppm of final frequency or within 100 Hz, whichever is greater, and amplitude settled to within 0.2 dB

³ Additional time may be required for the amplitude to settle within 0.2 dB when switching to or from frequencies < 500 kHz

⁴ Quoted specifications between 15 and 35 °C. Maximum output power typically decreases by 0.2 dB/°C for temperatures outside this range

⁵ Settable power +2 dB higher than specified

⁶ Settable power +30 dBm

⁷ Time from receipt of SCPI command or trigger signal to amplitude settled within 0.2 dB

⁸ Specification does not apply when switching from and to amplitudes where ALC levels are < -5 dBm for Option 540 or < 0 dBm for Option 520

⁹ Level accuracy applies from -20 dBm to maximum output power between 15 °C and 35 °C. For temperatures outside this range, absolute level accuracy degraded by 0.01 dB/°C for frequencies ≤ 4.5 GHz and 0.02 dB/°C for frequencies > 4.5 GHz. For instruments with Type-N connectors (Option 1ED), specifications are degraded typically 0.2 dB above 18 GHz. Specifications do not apply above the maximum specified power

¹⁰ N is a factor used to define certain FM and ΦM specifications in the instrument

¹¹ AM is specified at carrier frequencies > 2 MHz, ALC on, and when AM envelope does not exceed max power or go below -15 dBm for Option 520 or -20 dBm for Option 540

¹² Pulse specifications apply to frequencies > 500 MHz. Operable down to 10 MHz

¹³ Applies to power levels > -5 dBm for Option 1E1

¹⁴ With ALC off, power search on

Web Link

www.agilent.com/find/n5183a

- Complete function set at an ultra low initial cost
- Professional performance: 9 kHz to 3 GHz CW and swept output, 20 Hz to 80 kHz low frequency coverage, -127 to +13 dBm amplitude coverage, -95 dBm SSB phase noise, AM/FM/ΦM/pulse modulation
- Enhanced usability
- Optional analog IQ input (80 MHz RF bandwidth)

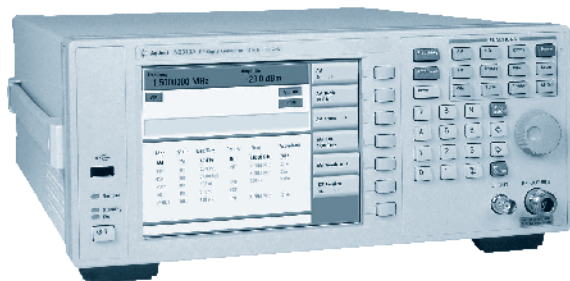

N9310A RF Signal Generator

The Agilent N9310A RF signal generator is one of the new products in Agilent low cost RF test and measurement family, offering ultra high price/performance for customers in consumer electronics manufacturing, base station installation and maintenance, and education teaching lab, as well as low cost research and development.

Rich function set in one box at an affordable price enables you to easily initiate your new projects. Adequate logical hardkeys and interface, USB connectivity, and SCPI compatible make either front panel operation or remote control easy to start-up. What is more, the multi-language user interface helps you to recognize the software menu faster and easier, accelerating front panel operations.

Now, with the exceptionally low price of the N9310A signal generator, you can afford to own Agilent test equipment you always wanted.

Specifications

Frequency

- Range: 9 kHz to 3.0 GHz
- Resolution: 0.1 Hz
- Switching speed: < 10 ms

Output

- Power: -127 to +13 dBm, +20 dBm settable
- Resolution: 0.1 dB
- Accuracy: ± 1 dB
- Switching speed: < 10 ms
- VSWR (typical):
 - < 1.6, $f_c = 1.5$ MHz to 2.5 GHz
 - < 1.8, $f_c = 2.5$ to 3.0 GHz
- Connector: N-type, 50 Ω nominal

Reversal power

- RF power: +36 dBm
 - DC voltage: ± 30 V
- 1 minute, the warning for reversed power protection is nominally +25 dBm

Time base reference oscillator

- Stability:
 - < ± 1 ppm/year, aging
 - < ± 1 ppm, temperature over 0 to 45 $^{\circ}\text{C}$
- Connector: BNC, female

External reference input

- Range: 2, 5, 10 MHz
- Amplitude: 0.5 to 2 Vrms
- Connector: BNC, female, 50 Ω

Spectral purity

- SSB phase noise: < -95 dBc/Hz, $f_c = 1$ GHz, at 20 kHz offset
- Residual FM: < 30 Hz rms, < 90 Hz peak, CW mode, $f_c = 1$ GHz, BW = 0.3 to 3 kHz, < 30 Hz rms, ResFM optimized mode
- Harmonics: < -30 dBc, Level ≤ 0 dBm, $f_c \geq 1$ MHz
- Non-harmonics: < -50 dBc, level ≤ 0 dBm, > 10 kHz from f_c

Sweep type:

- Step, list

Sweep mode:

- RF: 9 kHz to 3 GHz
- LF: 20 Hz to 80 kHz
- Amplitude: -127 to +13 dBm
- RF & amplitude

Analog modulation:

- AM/FM/ΦM/pulse

I/Q modulation (Option 001):

- Operating mode: external I/Q inputs
- VSWR: < 1.5
- Full scale input: 0.5 Vrms
- Modulation frequency range: DC to 40 MHz. At 3 dB points Mod frequency = 10 kHz
- QPSK EVM: 3%, typical, 1 Msps, 0.22 RRC filter
- GMSK phase error: 1.2 $^{\circ}$ rms. Typical, 1 Msps, BT = 0.5

Weight:

- 9.2 kg

Dimensions:

- 132.5 mm (H) x 320 mm (W) x 400 mm (D)

Ordering Information

N9310A-001 analog IQ input capability. This requires external stimulus

N9310A-1CM rackmount kit

N9310A-1TC hard transit case

N9310A-1HB handle and bumper

Web Link

www.agilent.com/find/N9310A

Vector Signal Generators

Key Specifications Comparison

N9310A
N5182A
E4438C
E8267D



N9310A



E4438C ESG



N5182A MXG

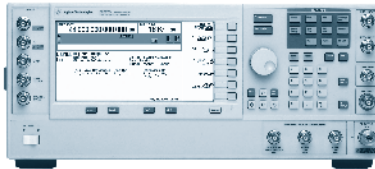

E8267D PSG

Vector Signal Generators

Whether you are working with wireless communications at RF or sophisticated pulse generation at microwave frequencies, Agilent provides a vector signal generator that will meet your needs. Ranging from basic to advanced performance up to 44 GHz, each instrument has a built-in I/Q modulator to support the complex modulation formats in modern wireless systems. Generate custom and proprietary test signals with a wide range of digital modulation formats or use Signal Studio software to simplify the creation of I/Q waveforms.

Side-by-Side Key Specifications Comparison

	Basic performance	Mid-performance	High performance	High performance
	N9310A Page 193	N5182A MXG Page 201	E4438C ESG Page 199	E8267D PSG Page 195
Key attributes	<ul style="list-style-type: none"> Optimized for low-cost consumer electronics manufacturing test, education, service and repair Large (6.5"), easy to operate color screen Optional I/Q modulator (ext. I/Q inputs only) USB interface, with flash memory stick support Localized GUI with 11 regional languages 	<ul style="list-style-type: none"> Industry-best ACPR and excellent EVM performance High output power Fast switching speeds Performance arbitrary waveform generator Low cost of ownership 	<ul style="list-style-type: none"> Optimized for R&D Advanced ARB and real-time baseband generator Digital I/Q inputs and outputs Internal BER analyzer Extensive signal creation software Low phase noise 	<ul style="list-style-type: none"> Optimized for R&D Integrated vector modulation up to 44 GHz Advanced ARB and real-time baseband generator High power Low phase noise Narrow pulse
Frequency range	9 kHz to 3 GHz	100 kHz to 3 or 6 GHz	250 kHz to 1, 2, 3, 4, 6 GHz	250 kHz to 20, 31.8, 44 GHz
Output power	+13 to -127 dBm	+23 to -127 dBm	+17 to -136 dBm	+18 to -130 dBm
Level accuracy	±1 dB	±0.6 to 1.7 dB	±0.5 to 1.5 dB	±0.6 to 2.0 dB
SSB phase noise (20 kHz Offset)	-95 dBc/Hz (at 1 GHz)	-121 dBc/Hz (at 1 GHz)	-134 dBc/Hz (at 1 GHz)	-126 dBc/Hz (at 10 GHz)
Harmonics	< -30 dBc	< -30 dBc	< -30 dBc	< -28 to < -55 dBc
Spurious	< -50 dBc	< -47 to < -68 dBc	< -58 to < -80 dBc	< -52 to < -80 dBc
Switching speed	< 10 ms	< 1.2 ms	< 9 ms	< 8 ms
Jitter (@622 MHz, 5 MHz BW)	—	47 µUI	46 µUI	19 µUI
BW internal baseband generator	—	100 MHz	80 MHz	80 MHz
BW external IQ inputs	40 MHz	> 160 MHz	> 160 MHz	> 2 GHz

- First microwave signal generator with integrated vector modulation up to 44 GHz
- Flexible waveform creation and correction software available
- Highest output power in the industry
- Excellent phase noise performance

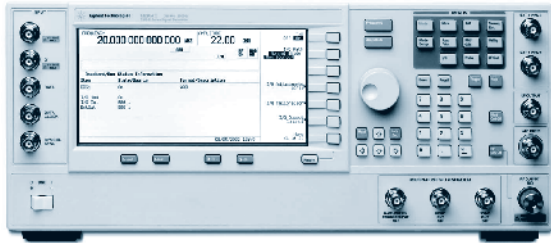

The Agilent PSG signal generators offer the features you need to be successful in today's complex technical environment. Whether working on radar systems, satellite communications, terrestrial microwave radio for broadband wireless access, or performing component tests, the PSG is the solution for you.

E8267D PSG Vector Signal Generator

- Integrated microwave vector signal generator operating up to 44 GHz
- Internal baseband generator achieves 80 MHz RF modulation bandwidth
- External I/Q inputs achieves 160 MHz RF modulation bandwidth, and 1.6 GHz ($f_c > 3.2$ GHz)
- Flexible waveform sequencing
- Flexible analog modulation formats: AM, FM, Φ M, and pulse
- Narrow pulse modulation (20 ns) down to 10 MHz
- Industry leading high output power
- Enhanced ultra-low phase noise

Flexibility for Any Application

Many systems, such as pulsed radar sets or broadband wireless communications, that operate at microwave frequencies need wide modulation bandwidths ranging from tens to hundreds of megahertz. E8267D features enable generation of vector modulated signals and include:

- Internal I/Q modulation capability
- Optional wideband I/Q inputs supporting RF modulation bandwidth of 2 GHz
- Optional internal baseband generator operates in dual mode, combining deep memory arbitrary waveform generator with a real-time baseband generator
- Standard two-tone and multitone utilities built into optional internal baseband generator
- Compatibility with Agilent's advanced design system (ADS), MATLAB and Excel

Signal Creation Software

Signal creation software is available for development and generation of waveforms with the internal baseband generator. These include calibrated AWGN, GPS personality and a GPS scenario generator.

Also create reference signals: pulse building, multitone, W-CDMA, GSM, WLAN, DVB-H, and more (For more details, see the Signal Studio section on page 203).

Specifications

Frequency

Range

- Option 520: 250 kHz to 20 GHz
- Option 532: 250 kHz to 31.86 GHz
- Option 544: 250 kHz to 44 GHz

Resolution

- CW: 0.001 Hz
- All Sweep modes: 0.01 Hz

Switching speed: < 16 ms (typical)

Phase offset: Adjustable in nominal 0.1° increments

Frequency bands

Band	Frequency range	N
1	250 kHz to 250 MHz	1/8
2	> 250 to 500 MHz	1/16
3	> 500 MHz to 1 GHz	1/8
4	> 1 to 2 GHz	1/4
5	> 2 to 3.2 GHz	1/2
6	> 3.2 to 10 GHz	1
7	> 10 to 20 GHz	2
8	> 20 to 28.5 GHz	3
9	> 28.5 to 44 GHz	5

Internal timebase reference oscillator

- Aging rate: < $\pm 3 \times 10^{-8}$ /year or < $\pm 2.5 \times 10^{-10}$ /day after 30 days

Temperature effects (typical): < $\pm 4.5 \times 10^{-9}$ 0 to 55 °C

Line voltage effects (typical): < $\pm 2 \times 10^{-10}$ for $\pm 10\%$ change

External reference frequency: 10 MHz only (within 1 ppm)

Step (digital) sweep

Operating modes

- Step sweep of frequency or amplitude or both (start to stop)
- List sweep of frequency or amplitude or both (arbitrary list)

Sweep range

- Frequency sweep: within instrument frequency range
- Amplitude sweep: within attenuator hold range

Dwell time 1 ms to 60 s

- Frequency settling time: 8 ms (typical)
- Amplitude settling time: 5 ms (typical)

Number of points

- Step sweep: 2 to 65535
- List sweep: 2 to 1601 per table

Triggering: Auto, external, single, or GPIB

Ramp (analog) sweep (Option 007)

Operating modes

- Synthesized frequency sweep (start/stop), (center/span), (swept CW)
- Power (amplitude) sweep (start/stop)
- Manual sweep: RPG control between start and stop frequencies
- Alternate successive sweeps between current and stored states

Sweep span range: Settable from minimum to full range

Triggering: Auto, external, single, or GPIB

Output power

Minimum settable power (dBm): -130

Maximum output power (dBm)

	Option 520 spec (typ)	Options 532 and 544 spec (typ)
250 kHz to 10 MHz	+14 (+17)	+13 (+16)
10 to < 60 MHz	+16 (+19)	+15 (+18)
60 to 400 MHz	+21 (+22)	+20 (+21)
> 0.4 to 3.2 GHz	+22 (+24)	+21 (+23)
> 3.2 to 10 GHz	+18 (+23)	+14 (+21)
> 10 to 20 GHz	+18 (+22)	+14 (+18)
> 20 to 32 GHz	—	+14 (+18)
> 32 to 40 GHz	—	+12 (+18)
> 40 to 44 GHz	—	+10 (+13)

Step attenuator: 0 to 115 dB in 5 dB steps

Amplitude switching speed

- CW or analog modulation: < 3 ms (typical) (without power search)

Level accuracy (dB)

Frequency	+16 to +10 dBm	+10 to -10 dBm	-10 to -70 dBm	-70 to -90 dBm
250 kHz to 2 GHz	± 0.6	± 0.6	± 0.7	± 0.8
> 2 to 20 GHz	± 0.8	± 0.8	± 0.9	± 1.0
> 20 to 32 GHz	± 1.0	± 0.9	± 1.0	± 1.7
> 32 to 44 GHz	± 1.0	± 0.9	± 1.5	± 2.0

E8267D

CW level accuracy with I/Q modulation (relative to CW) (with PRBS modulated data)

With ALC on:

- QAM or QPSK formats: ± 0.2 dB
- Constant-amplitude formats (FSK, GMSK, etc): ± 0.2 dB

With ALC off: ± 0.2 dB (typical)

Resolution: 0.01 dB

Temperature stability: 0.01 dB/°C (typical)

User flatness correction

- Number of points: 2 to 1601 points/table
- Number of tables: up to 10,000, memory limited

Output impedance: 50 Ω (nominal)

SWR (internally leveled) (typical)

- 250 kHz to 2 GHz: $< 1.4:1$
- > 2 GHz to 20 GHz: $< 1.6:1$
- > 20 GHz: $< 1.8:1$ (typical)

Leveling modes

- Internal leveling, external detector leveling, millimeter source module, ALC off

Maximum reverse power: 1/2 Watt (nominal), 0 V DC

Spectral purity

Harmonics (dBc at +10 dBm or maximum specified output power, whichever is lower)

Frequency	
< 1 MHz	-25 (typ)
1 to 10 MHz	-25
10 to 50 MHz	-28
10 to 50 MHz with Option 1EH filters on	-45
0.05 to 2 GHz	-30
0.05 to 2 GHz with Option 1EH filters on	-55
2 to 20 GHz	-55
20 to 67 GHz	-45 (typ)

SSB phase noise (CW), 20 kHz offset from carrier (dBc/Hz)

Frequency	Spec (typ)
250 kHz to 250 MHz	-130 (-134)
> 250 to 500 MHz	-134 (-138)
> 500 MHz to 1 GHz	-130 (-134)
> 1 to 2 GHz	-124 (-128)
> 2 to 3.2 GHz	-120 (-124)
> 3.2 to 10 GHz	-110 (-113)
> 10 to 20 GHz	-104 (-108)
> 20 to 28.5 GHz	-100 (-104)
> 28.5 to 44 GHz	-96 (-100)

Option UNX: ultra-low phase noise (CW)

Offset from carrier (dBc/Hz)

Frequency	100 Hz spec (typ)	1 kHz spec (typ)	10 kHz spec (typ)	100 kHz spec (typ)
250 kHz to 250 MHz	-104 (-120)	-121 (-128)	-128 (-132)	-130 (-133)
> 250 to 500 MHz	-108 (-118)	-126 (-132)	-132 (-136)	-136 (-141)
> 500 MHz to 1 GHz	-101 (-111)	-121 (-130)	-130 (-134)	-130 (-135)
> 1 to 2 GHz	-96 (-106)	-115 (-124)	-124 (-129)	-124 (-129)
> 2 to 3.2 GHz	-92 (-102)	-111 (-120)	-120 (-124)	-120 (-124)
> 3.2 to 10 GHz	-81 (-92)	-101 (-109)	-110 (-114)	-110 (-115)
> 10 to 20 GHz	-75 (-87)	-95 (-106)	-104 (-107)	-104 (-109)
> 20 to 28.5 GHz	-72 (-83)	-92 (-102)	-100 (-103)	-100 (-105)
> 28.5 to 44 GHz	-68 (-77)	-88 (-97)	-96 (-99)	-96 (-101)

Option UNY enhanced ultra-low phase noise (CW)

Offset from carrier (dBc/Hz)

Frequency	100 Hz spec (typ)	1 kHz spec (typ)	10 kHz spec (typ)	100 kHz spec (typ)
250 kHz to 250 MHz	-104 (-120)	-121 (-128)	-140 (-144)	-140 (-143)
> 250 to 500 MHz	-108 (-118)	-126 (-132)	-144 (-148)	-146 (-151)
> 500 MHz to 1 GHz	-101 (-111)	-121 (-130)	-142 (-146)	-140 (-145)
> 1 to 2 GHz	-96 (-106)	-115 (-124)	-136 (-141)	-134 (-139)
> 2 to 3.2 GHz	-92 (-102)	-111 (-120)	-132 (-136)	-130 (-134)
> 3.2 to 9 GHz	-81 (-92)	-101 (-109)	-122 (-126)	-120 (-125)
> 10 to 20 GHz	-75 (-87)	-95 (-106)	-116 (-119)	-114 (-119)
> 20 to 28.5 GHz	-72 (-83)	-92 (-102)	-112 (-115)	-110 (-115)
> 28.5 to 44 GHz	-68 (-77)	-88 (-97)	-108 (-111)	-106 (-111)

Broadband noise

- (CW mode at +10 dBm output, for offsets > 10 MHz)
- > 2.4 to 20 GHz: < -148 dBc/Hz (typical)
- > 20 GHz: < -141 dBc/Hz (typical)

Option UNT

- AM, FM, phase modulation, and LF output

Frequency modulation

Maximum deviation: N x 16 MHz

Modulation frequency response

Path	Rates (at 100 kHz deviation)	
	1 dB bandwidth	3 dB bandwidth (typical)
FM 1	DC to 100 kHz	DC to 10 MHz
FM 2	DC to 100 kHz	DC to 1 MHz

Phase modulation

Maximum deviation

- N x 160 radians (N x 16 radians in high-bandwidth mode)

Modulation frequency response

Mode	Rates (3 dB BW)
Normal BW	DC to 100 kHz
High BW	DC to 1 MHz (typical)

Amplitude modulation ($f_c > 2$ MHz) (typical)

Depth	Linear mode	Exponential (log) mode (downward modulation only)
Maximum	$> 90\%$	> 20 dB
Settable	0 to 100%	0 to 40 dB
Resolution	0.1%	0.01 dB

Accuracy (1 kHz rate) $< \pm(6\%$ of setting + 1%) $< \pm(2\%$ of setting + 0.2 dB)

Rates (3 dB bandwidth, 30% depth)

- DC to 100 kHz (typical) (useable to 1 MHz)

Wide band AM

Rate (typical 1 dB bandwidth)

- ALC on: 1 kHz to 80 MHz
- ALC off: DC to 80 MHz

External modulation inputs (Ext1 & Ext2)

Modulation types: AM, FM, and Φ M

Input impedance: 50 or 600 Ω (nominal) switched

Simultaneous modulation

All modulation types may be simultaneously enabled except: FM with Φ M, linear AM with exponential AM, and Wideband AM with I/Q. AM, FM, and Φ M can sum simultaneous inputs from any two sources (Ext1, Ext2, internal1, or internal2). Any given source (Ext1, Ext2, internal1, or internal2) may be routed to only one activated modulation type.

Internal modulation source

Dual function generators provides two independent signals (internal1 and internal2) for use with AM, FM, Φ M, or LF out.

Waveforms: Sine, square, positive ramp, negative ramp, triangle, Gaussian noise, uniform noise, swept sine, dual sine.

LF out: Output: internal1 or internal2

Pulse modulation (Option UNU)

	500 MHz to 3.2 GHz	Above 3.2 GHz
On/off ratio	80 dB (typ)	80 dB
Rise/fall times (Tr, Tf)	100 ns (typ)	6 ns (typ)
Minimum pulse width	Internally leveled	2 μ s
	Level hold (ALC off with power search)	0.5 μ s
Repetition frequency	Internally leveled	10 Hz to 250 kHz
	Level hold (ALC off with power search)	DC to 1 MHz
		DC to 3 MHz

Narrow pulse modulation (Option UNW)

	10 MHz to 3.2 GHz	Above 3.2 GHz
On/off ratio	80 dB	80 dB
Rise/fall times (Tr, Tf)	10 ns (8 ns typ)	10 ns (6 ns typ)
Minimum pulse width	Internally leveled	1 μ s
	Level hold (ALC off with power search)	20 μ s
Repetition frequency	Internally leveled	10 Hz to 500 kHz
	Level hold (ALC off with power search)	DC to 5 MHz

Internal pulse generator

Modes

- Free-run, triggered, triggered with delay, doublet, and gated. Triggered with delay, doublet, and gated require external trigger source

Period (PRI) (Tp)

- 70 ns to 42 s (repetition frequency: 0.024 Hz to 14.28 MHz)

Pulse width (Tw): 10 ns to 42 s

Resolution: 10 ns (width, delay, and PRI)

Vector modulation

External I/Q inputs

- Input impedance: switched 50 or 600 W (nominal)
- Input range: minimum 0.1 V_{rms} , Maximum 1 V_{peak}
- Flatness: ± 1 dB within ± 40 MHz of carrier (with ALC off) (typical)

I/Q adjustments

- I & Q offsets
 - External inputs (600 Ω) ± 5 Volts
 - External inputs (50 Ω) $\pm 50\%$
 - Internal baseband generator $\pm 50\%$
- I/Q attenuation: 0 to 40 dB
- I/Q gain balance: ± 4 dB
- I/Q quadrature skew: $\pm 10^\circ$ range (typical)
- Low pass filter: selectable 40 MHz or through

I/Q baseband outputs

- Differential: I, I bar, Q, Q bar
- Single ended: I, Q
- Frequency range: DC to 40 MHz

Wideband external differential I/Q inputs (Option 016)

RF output frequency range

- 250 MHz to 3.2 GHz
- 3.2 to 44 GHz

Input

- Input (baseband) frequency range: DC to 130 MHz (nominal) for 250 MHz to 3.2 GHz output; DC to 1 GHz for 3.2 to 44 GHz (nominal)

RF path filters

- Carrier frequency: low-pass 3 dB cutoff frequency (nominal)
- > 250 to 396 MHz: 200 to 420 MHz bandpass filter
- > 396 to 698 MHz: 350 to 650 MHz bandpass filter
- > 628 to 1000 MHz: 1040 MHz low pass filter
- > 1 to 1.5 GHz: 1.6 GHz low pass filter
- > 3.2 to 5 GHz: 5.5 GHz low pass filter
- > 5 to 8 GHz: 8.9 GHz low pass filter
- > 8 to 12.8 GHz: 13.9 GHz low pass filter
- > 12.8 GHz: 22.5 GHz low pass filter
- > 20 to 24 GHz: 19.6 to 24.5 GHz band pass filter
- > 24 to 28.5 GHz: 23.5 to 29.0 GHz band pass filter
- > 28.5 to 32 GHz: 28 to 32.5 GHz band pass filter
- > 32 to 36 GHz: 31.7 to 36.5 GHz band pass filter
- > 36 to 40 GHz: 35.5 to 40.4 GHz band pass filter
- > 40 to 44 GHz: 39.5 to 44.3 GHz band pass filter

I/Q baseband generator (arbitrary waveform mode) (Options 602)

Channels

- 2 (I and Q)

Resolution

- 16 bits (1/65,536)

Baseband waveform memory

- Length (playback): 64 Msamples/channel (Option 602)
- Length (storage): 1.2 Gsamples on 8 GB hard drive (Option 009)

Waveform segments

- Segment length: 60 samples to 64 Msamples
- Maximum number of segments: 8,192

Waveform sequences

- Maximum total number of segments: 16,384
- Sequencing: continuously repeating
- Maximum number of sequences: 16,384
- Maximum segments/sequence: 1 to 32,768
- Maximum segment repetitions: 1 to 65,536

Clock

- Sample rate: 1 Hz to 100 MHz
- Resolution: 0.001 Hz

Reconstruction filter: (fixed)

- 50 MHz (used for all symbol rates)

Multi-carrier

- Number of carriers: up to 100 (limited by a max bandwidth of 80 MHz depending on symbol rate and modulation type)
- Frequency offset (per carrier): -40 MHz to $+40$ MHz
- Power offset (per carrier): 0 dB to -40 dB

Modulation

- PSK: BPSK, QPSK, OQPSK, $\pi/4$ DQPSK, 8PSK, 16PSK, D8PSK
- QAM: 4, 16, 32, 64, 256
- MSK, ASK, FSK: selectable: 2, 4, 8, 16
- Data: random only

Two-tone

- Frequency spacing: 100 Hz to 80 MHz (symmetrical about carrier)
- IM distortion
- 250 kHz to 3.2 GHz: < -45 dBc for RF levels < 0 dBm (typical)
- > 3.2 to 20 GHz: < -55 dBc for RF levels < 0 dBm (typical)

I/Q baseband generator (real-time mode) (Options 602)

Basic modulation types (custom format)

- PSK: BPSK, QPSK, OQPSK, $\pi/4$ DQPSK, 8PSK, 16PSK, D8PSK
- MSK: user-defined phase offset from 0 to 100°
- QAM: 4, 16, 32, 64, 128, 256
- FSK: selectable: 2, 4, 8, 16 level symmetric
- ASK
- User defined: custom map of up to 16 deviation levels
- Symbol rate: maximum deviation
- < 5 MHz: 4 times symbol rate
- 5 to 50 MHz: 20 MHz

I/Q

- Custom map of 256 unique values

FIR filter

- Selectable: Nyquist, root Nyquist, gaussian, rectangular, custom FIR
- α : 0 to 1, BbT: 0.1 to 1

Symbol rate

- For external serial data: adjustable from 1000 symbols/sec to a maximum symbol rate of 50 Mbits/sec \div #bits/symbol
- For internally generated data: adjustable from 1000 symbols/sec to 50 Msymbols/sec. and a maximum of 8 bits per symbol. Modulation quality may be degraded at high symbol rates

Data types

- Internally generated data
 - Pseudo-random patterns: PN9, PN11, PN15, PN20, PN23
 - Repeating sequence: Any 4-bit sequence, other fixed patterns
- Direct-pattern RAM (PRAM)
 - Max size: 64 Mbits (each bit uses an entire sample space)
 - Use: non-standard framing
- User file
 - Max size: 3.2 Mbytes
 - Use: continuous modulation or internally generated TDMA standard
- Externally generated data
 - Type: serial data
 - Inputs: data, bit clock, symbol sync accepts data rates $\pm 5\%$ of specified data rate

Generate up to sixteen phase-coherent signals

Testing multireceiver systems in phased-array radar, communications networks, and synthetic aperture radar has traditionally been difficult and expensive. Field-testing, while perhaps necessary for final system verification, is expensive in the design phase. The phase-coherent simulation system, with up to 16 E8267D PSGs and some special

E8267D

options, provides a more repeatable, configurable alternative for the laboratory or the flight line. As shown, one PSG is the master, delivering the fundamental LO signal to the distribution network, which distributes this signal back to the master and all slaves as a common reference. The ESG is the clock source, driving the external clock inputs of each PSG's internal baseband generator. The system provides full-phase coherency needed for testing multi-receiver systems, as well as full control over time, phase, amplitude and frequency.

Change the waveform sequence dynamically during playback

In a system level test environment, the ability to dynamically change the stimulus waveform without discontinuity is a distinct advantage. The E8267D dynamic sequencing special Option SP2 enhances the "segment advance" capability of Option 601/602 arbitrary waveform generator to allow jumping to any of 256 different waveform segments in the playback memory. The sequencing enhancement allows determination of the next segment to be made dynamically via an 8-bit value strobe into the rear panel auxiliary I/O D-type connector.

General

Power requirements

- 90 to 267 Vac 50 to 60 Hz, (automatically selected) 400 W typical, 650 W maximum

Operating temperature range

- 0 to 55 °C

Compatibility

- OML Inc. – AG Series mm-wave source modules
- Agilent Technologies EPM Series power meters

Weight

- < 25 kg (54 lb.) net, < 33 kg (74 lb.) shipping

Dimensions

- 178 mm (H) x 426 mm (W) x 515 mm (D) (7 in x 16.8 in x 20.3 in)

Ordering Information

Frequency range

- E8267D-520** 250 kHz to 20 GHz
- E8257D-532** 250 kHz to 31.8 GHz
- E8267D-544** 250 kHz to 44 GHz

Performance enhancements

- E8267D-602** internal baseband generator, 64 MSa memory
- E8267D-003** PSG digital output connectivity with N5102A
- E8267D-004** PSG digital input connectivity with N5102A
- E8267D-007** analog ramp sweep and scalar network analyzer interface
- E8267D-009** 8 GB removable flash memory
- E8267D-016** wideband external I/Q inputs
- E8267D-403** calibrated AWGN
- E8267D-409** global Positioning System (GPS) personality
- E8267D-422** scenario generator for GPS personality
- E8267D-1EH** improved harmonics below 2 GHz (low-pass filters)
- E8267D-UNT** AM, FM, phase modulation and LF output
- E8267D-UNU** pulse modulation
- E8267D-UNW** narrow pulse modulation
- E8267D-1SM** scan modulation
- E8267D-UNX** ultra-low phase noise
- E8267D-UNY** enhanced ultra-low phase noise
- E8267D-1ED** type-N(f) RF output connector (Option 520 only)
- E8267D-1EM** moves all front panel connectors to the rear panel

Special Options

- E8267D-SP2** dynamic sequencing capability
- E8267D-H1S** 1 GHz external frequency reference input
- E8267D-H1G** connections for phase coherency and improved phase stability < 250 MHz
- E8267D-HCC** connections for phase coherency > 250 MHz
- E8267D-H18** wideband downconverter

Web Link

www.agilent.com/find/psg

4

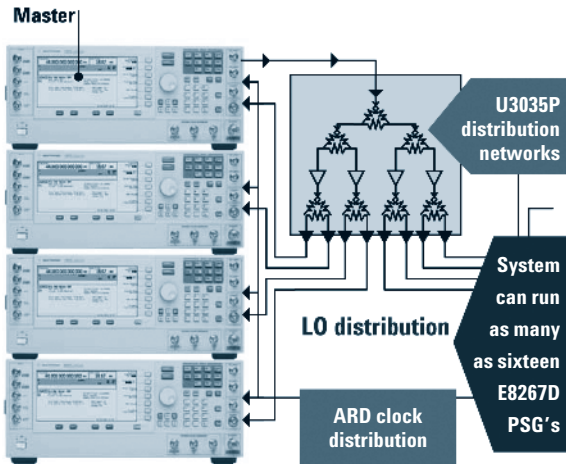

Lock up to sixteen PSG vector signal generators to achieve phase coherency with special Option HCC

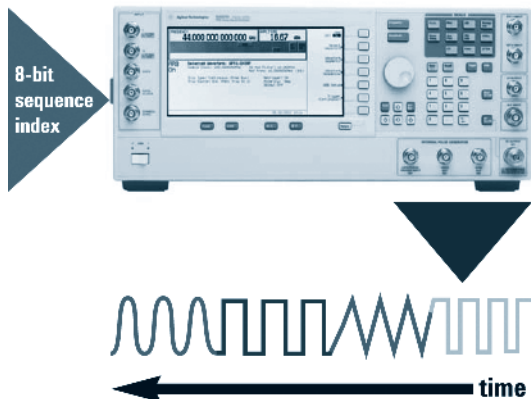

Jump to different waveform segments seamlessly with special Option SP2

- Frequency range from 100 kHz to 1, 2, 3, 4 or 6 GHz
- Dual mode real-time and arbitrary waveform IQ baseband generator
- Excellent spectral purity

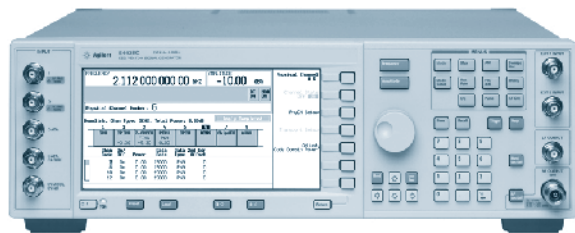

E4438C ESG RF vector signal generator

The E4438C ESG's high spectral purity, powerful baseband generator, and application-specific personalities make it the clear choice for development and manufacturing from the component to the system level.

Superior Dual Mode Baseband Generator

Flexible arbitrary waveform generator supporting 80 MHz RF bandwidth and 64 Msamples of playback memory.

Connectivity to N5106A PXB baseband generator and channel emulator. Ideal for design validation or functional test where single or multi-channel fading is needed such as LTE conformance testing with MIMO.

Powerful real-time applications:

- HSPA allows closed loop HARQ throughput performance testing
- Multi-satellite GPS: > 30 minutes of scenario playback. Pair with 8960 for A-GPS testing
- Custom modulation: user defined modulation with data sourced internally or from an external serial port
- AWGN: non-repeating noise with settable Eb/No or C/N ratio for any technology

Digital Baseband IQ Inputs and Outputs

Accelerate device verification without waiting for your analog baseband section to be complete. The ESG E4438C digital IQ inputs and outputs are enabled when paired with the N5102A digital signal interface module.

Excellent Spectral Purity

Use the E4438C with low phase noise Option UNJ for LO substitution, low-jitter clock stimulus, blocking/interference signals, and in-channel measurements close to the carrier.

Broadest and Most Trusted Signal Creation Software

Create reference signals: LTE, HSPA+, W-CDMA, GSM, cdma2000, WLAN, WiMAX, DVB-H, DAB and more. See the section on Signal Studio for a more detailed list of applications.

Specifications for Frequency and Power Characteristics

Frequency range

Option:

- **501:** 250 kHz to 1 GHz
- **502:** 250 kHz to 2 GHz
- **503:** 250 kHz to 3 GHz
- **504:** 250 kHz to 4 GHz
- **506:** 250 kHz to 6 GHz (requires Option UNJ)

Frequency switching speed³

	Option 501-504		Option 501-504 w/UNJ		With Option 506	
	Freq. ¹	Freq./Amp. ²	Freq. ¹	Freq./Amp. ²	Freq. ¹	Freq./Amp. ²
Digital modulation on	< 35 ms	< 49 ms	< 35 ms	< 52 ms	< 41 ms	< 57 ms
Digital modulation off	< 9 ms	< 9 ms	< 9 ms	< 9 ms	< 16 ms	< 17 ms

Digital modulation

on	< 35 ms	< 49 ms	< 35 ms	< 52 ms	< 41 ms	< 57 ms
off	< 9 ms	< 9 ms	< 9 ms	< 9 ms	< 16 ms	< 17 ms

Internal reference oscillator

- Aging rate: < ±1 ppm/yr < ±0.1 ppm/yr or < ±0.0005 ppm/day after 45 days

RF reference input requirements

- Frequency: 1, 2, 5, 10 MHz ± 0.2 ppm

Output power

	Option 501-504	With Option UNB	Option 506
250 kHz to 250 MHz	+11 to -136 dBm	+15 to -136 dBm	+12 to -136 dBm
> 250 MHz to 1 GHz	+13 to -136 dBm	+17 to -136 dBm	+14 to -136 dBm
> 1 to 3 GHz	+10 to -136 dBm	+16 to -136 dBm	+13 to -136 dBm
> 3 to 4 GHz	+7 to -136 dBm	+13 to -136 dBm	+10 to -136 dBm
> 4 to 6 GHz	—	—	+10 to -136 dBm

Level accuracy (dB)

With Option 506^{3,4}

Power level	+7 to -50 dBm	-50 to -110 dBm	-110 to -127 dBm	< -127 dBm
250 kHz to 2 GHz	±0.6	±0.8	±0.8	(±1.5)
2 to 3 GHz	±0.6	±0.8	±1.0	(±2.5)
3 to 4 GHz	±0.8	±0.9	±1.5	(±2.5)
4 to 6 GHz	±0.8	±0.9	(±1.5)	

Level switching speed³

	Option 501-504	Option UNB	Option 506
Normal operation (ALC on)	< 15 ms	< 21 ms	< 21 ms

Spectral purity

SSB phase noise (at 20 kHz offset)³

	Option 501-504	With Option UNJ
at 500 MHz	< -124 dBc/Hz	< -135 dBc/Hz, (< -138 dBc/Hz)
at 1 GHz	< -118 dBc/Hz	< -130 dBc/Hz, (< -134 dBc/Hz)
at 3 GHz	< -106 dBc/Hz	< -121 dBc/Hz, (< -125 dBc/Hz)
at 6 GHz	N/A	< -113 dBc/Hz, (< -117 dBc/Hz)

Specifications for Analog Modulation

Frequency bands	Frequency range	N #
1	250 kHz to ≤ 250 MHz	1
2	> 250 to ≤ 500 MHz	0.5
3	> 500 MHz to ≤ 1 GHz	1
4	> 1 to ≤ 2 GHz	2
5	> 2 to ≤ 4 GHz	4
6	> 4 to ≤ 6 GHz	8

Frequency modulation^{6,7}

Maximum deviation⁵

- Option 501-504: N x 8 MHz
- With Option UNJ: N x 1 MHz

Coupling	Modulation frequency rate ³ (deviation = 100 kHz)	
	1 dB bandwidth	3 dB bandwidth
FM path 1 (DC)	DC to 100 kHz	(DC to 10 MHz)
FM path 2 (DC)	DC to 100 kHz	(DC to 0.9 MHz)
FM path 1 (AC)	20 Hz to 100 kHz	(5 Hz to 10 MHz)
FM path 2 (AC)	20 Hz to 100 kHz	(5 Hz to 0.9 MHz)

Phase modulation^{6,7}

Modulation Frequency Response^{3,5}

	Mode	Maximum deviation	Allowable rates (3 dB BW)	
			ΦM path 1	ΦM path 2
Standard	Normal BW	N x 80 rad	DC to 100 kHz	DC to 100 kHz
	High BW	N x 8 rad N x 1.6 rad	(DC to 1 MHz) (DC to 10 MHz)	(DC to 0.9 MHz) (DC to 0.9 MHz)
With Option UNJ	Normal BW	N x 10 radians	DC to 100 kHz	DC to 100 kHz
	High BW	N x 1 radians	(DC to 1 MHz)	(DC to 0.9 MHz)

Amplitude modulation⁸ (f_c > 500 kHz)

Range

- 0 to 100%

Rates (3 dB bandwidth)

- DC coupled: 0 to 10 kHz, AC coupled: 10 Hz to 10 kHz

E4438C

Wideband AM

- Rates** (1 dB bandwidth)³
- ALC on (400 Hz to 40 MHz)
 - ALC off (DC to 40 MHz)

Pulse modulation

On/off ratio³

- < 4 GHz > 80 dB
- ≤ 4 GHz (> 64 dB)

Rise/fall times³

- (150 ns)

Minimum width³

- ALC on (2 μs), ALC off (400 ns)

Pulse repetition frequency³

- ALC on (10 Hz to 250 kHz), ALC off (DC to 1.0 MHz)

Internal pulse generator

- Square wave rate: 0.1 Hz to 20 kHz
- Pulse
 - Period: 8 μs to 30 seconds
 - Width: 4 μs to 30 seconds
 - Resolution: 2 μs

Internal analog modulation source

Waveforms

- sine, square, ramp, triangle, pulse, noise

Rate range

- Sine: 0.1 Hz to 100 kHz
- Square, ramp, triangle: 0.1 Hz to 20 kHz

Swept sine mode (frequency, phase continuous)

- Operating modes: triggered or continuous sweeps
- Frequency range: 0.1 Hz to 100 kHz

Dual sinewave mode

- Frequency range: 0.1 Hz to 100 kHz
- Amplitude ratio: 0 to 100%

Composite modulation

- AM, FM, and ΦM each consist of two modulation paths which are summed internally for composite modulation

Simultaneous modulation

- Simultaneously enable multiple modulation types (some exceptions)

Baseband generator (arbitrary waveform mode) (Option 601 or 602)

Channels/resolution

- 2 (I and Q)/16 bits

Arbitrary waveform memory

- Maximum playback capacity: 8 or 64 Msamples/channel (Option 601 or 602)
- Maximum storage capacity
 - 1.2 Gsamples (Option 005)
 - 2.8 Msample (standard)

Clock

- Sample rate: 1 Hz to 100 MHz

Modulation

- PSK: BPSK, QPSK, OQPSK, π/4DQPSK, 8PSK, 16PSK, D8PSK
- QAM: 4, 16, 32, 64, 128, 256
- ASK, MSK, FSK: selectable: 2, 4, 8, 16

Multitone

- Number of tones: 2 to 64, with selectable on/off state per tone

Baseband generator (real-time mode) (Option 601 or 602)

Basic modulation types (custom format)

- PSK: BPSK, QPSK, OQPSK, π/4DQPSK, 8PSK, 16PSK, D8PSK
- MSK: user-defined phase offset from 0 to 100°
- ASK: user defined depth from 0.001 to 100%
- QAM: 4, 16, 32, 64, 128, 256
- FSK: user defined: custom map of up to 16 deviation levels

Symbol rate

- Adjustable up to 50 Mb/s/sec

Data types

- Pseudo-random patterns: PN9, PN11, PN15, PN20, PN23
- User file
- Externally streamed serial data

3GPP W-CDMA distortion performance

Offset	Config	Spec	Typ
	1 DPCH	-65 dBc	(-67 dBc)
Adj (5MHz)	64 DPCH	-63 dBc	(-66 dBc)

Weight

- < 16 kg (35 lb.) net, < 23 kg (50 lb.) shipping

Dimensions

- 133 mm (H) x 426 mm (W) x 432 mm (D) (5.25 in x 16.8 in x 17 in)

Remote programming

- Interface: GPIB (IEEE-488.2-1987), RS-232, LAN (10BaseT)

Control languages

- SCPI version 1996.0

Signal Creation Software

E4438C-400 3GPP W-CDMA with HSDPA

E4438C-401 cdma2000 and IS-95A

E4438C-402 TDMA (GSM, GPRS, EDGE, EGPRS, DADC, PCD, PHS, TETRA, DECT)

E4438C-403 calibrated noise

E4438C-409 GPS

E4438C-422 scenario generator for GPS

Also, create reference signals: LTE, HSPA+, W-CDMA, GSM, WLAN, DVB-H, and more (For more details, see the Signal Studio section on page 203).

Ordering Information

Frequency ranges

E4438C-501 250 kHz to 1 GHz (electronic attenuator standard)

E4438C-502 250 kHz to 2 GHz (electronic attenuator standard)

E4438C-503 250 kHz to 3 GHz (electronic attenuator standard)

E4438C-504 250 kHz to 4 GHz (electronic attenuator standard)

E4438C-506 250 kHz to 6 GHz (requires Option UNJ, mechanical attenuator only)

Performance enhancements

E4438C-UNB high output power with mechanical attenuator (for Option 501–504 models only)

E4438C-UNJ enhanced phase noise performance

E4438C-1EM move all front panel connectors to rear

E4438C-601 internal baseband generator with 8 Msamples with digital bus capability

E4438C-602 internal baseband generator with 64 Msamples with digital bus capability

E4438C-003 enables digital output connectivity with N5102A

E4438C-004 enables digital input connectivity with N5102A

E4438C-005 6 Gbyte internal hard drive

E4438C-UN7 internal bit-error-rate analyzer

E4438C-HEC external baseband clock input

E4438C-HBC phase coherent carriers up to 6 GHz

E4438C-HCC phase coherent carriers up to 4 GHz

E4438C-UK6 hardcopy of the commercial calibration certificate and calibration test data

See Signal Studio section on page 203 for Signal Studio software ordering information.

Accessories

E4438C-1CM rackmount flange kit

E4438C-1CN front handle kit

E4438C-1CP rackmount flange and front handle kit

¹ To within 0.1 ppm of final frequency above 250 MHz or within 100 Hz below 250 MHz

² Frequency switching time with the amplitude settled within ±0.1 dB

³ Parentheses denote typical performance

⁴ Quoted specifications for 23 °C ± 5 °C. Accuracy degrades by less than 0.02 dB/°C over full temperature range. Accuracy degrades by 0.2 dB above +7 dBm

⁵ Refer to frequency bands on this page for N values

⁶ All analog performance above 4 GHz is typical

⁷ For non-Option UNJ units, specifications apply in phase noise mode 2 (default)

⁸ AM is typical above 3 GHz or if wideband AM or I/Q modulation is simultaneously enabled

Web Link

www.agilent.com/find/e4438c

- Frequency range from 100 kHz to 1, 3 or 6 GHz
- Industry-best ACPR and excellent EVM performance
- High output power
- Fast switching speeds
- Low cost of ownership



N5182A MXG RF vector signal generator

Designed for the Most Demanding Manufacturing Lines

Featuring fast frequency, amplitude, waveform switching, high power with an electronic attenuator, and high reliability – all in two rack units (2RU) – Agilent MXG vector is optimized for manufacturing cellular communications, wireless connectivity components and audio/video receivers. MXG vector provides better value for your investment by increasing throughput, improving test yield, maximizing uptime, and saving rack space. With scalable RF and baseband performance, the MXG vector is easily configured to meet your specific test needs.

Best-in-Class RF Performance for Tomorrow's Design's

With the industry's best combination of high power and distortion performance the MXG vector ensures that you are measuring your device and not the test equipment. When combined with flexible signal creation tools such as Signal Studio software, the low ACLR & EVM makes the MXG a complete R&D solution for W-CDMA, LTE, and more.

Industry – Best ACPR

- Decrease test uncertainty in manufacturing and increase yields
- Better device characterization in R&D

High Output Power

- Compensate for system losses or drive your device into compression with > +23 dBm output power

Fast Switching Speeds

- Increase throughput with arbitrary switching of frequency and amplitude ≤ 1.2 ms or ≤ 900 μ s in list mode

Maximize Uptime

- Low cost of ownership is ensured with simplified self-maintenance for repair and performance verification. Downtime kept under 2 hours with use of field-replaceable assemblies

Powerful Features

- Synchronize multiple MXG's for coherent MIMO operation
- Broadband channel corrections for wide band signals
- Digital I/O, fading, and more with PXB baseband generator and channel emulator

N5182A Catalog Specifications

See N5182A MXG and N5162A MXG ATE vector signal generator data sheet, literature number 5989-5261EN for warranted specifications.

Frequency range

- Option 503: 100 kHz to 3 GHz
- Option 506: 100 kHz to 6 GHz

Frequency switching speed¹

Type	Standard	Option UNZ	Option UNZ (typical)
Digital modulation on	SCPI mode	≤ 5 ms (typ)	≤ 1.15 ms
	List/step sweep mode	≤ 5 ms (typ)	≤ 900 μ s

Internal time base reference oscillator aging rate

- $\leq \pm 5$ ppm/10 yrs, $< \pm 1$ ppm/yr (nom)

External reference input frequency

- Option 1ER: 1 to 50 MHz (10 MHz standard)

Output power

- Minimum with Option 1EQ: -127 dBm (-110 dBm standard)

Maximum output power

Range	Standard	Option 1EA
> 100 KHz to 50 MHz	+13 dBm	+15 dBm
> 50 MHz to 3.0 GHz	+13 dBm	+23 dBm
> 3.0 to 5.0 GHz	+13 dBm	+17 dBm
> 5.0 GHz	+11 dBm	+16 dBm

Amplitude switching speed²

Type	Standard	Option UNZ	Option UNZ (typical)
Digital modulation on	SCPI mode	≤ 5 ms (typ)	≤ 1.15 ms
	List/step sweep mode	≤ 5 ms (typ)	≤ 900 μ s

Absolute level accuracy (ALC on)

	Standard		Option 1EQ
	+23 ³ to -60 dBm	< -60 to -110 dBm	< -110 to -127 dBm
100 to 250 kHz	± 0.6 dB	± 1.0 dB	—
> 250 kHz to 1 MHz	± 0.6 dB	± 0.7 dB	± 1.7 dB
> 1 MHz to 1 GHz	± 0.6 dB	± 0.7 dB	± 1.0 dB
> 1 to 3 GHz	± 0.6 dB	± 0.8 dB	± 1.1 dB
> 3 to 4 GHz	± 0.7 dB	± 0.8 dB	± 1.1 dB
> 4 to 6 GHz	± 0.8 dB	± 1.1 dB	± 1.3 dB

Spectral purity

Single sideband phase noise (at 20 kHz offset)

- 1 GHz: ≤ -121 dBc/Hz (typ)
- 3 GHz: ≤ -110 dBc/Hz (typ)
- 6 GHz: ≤ -104 dBc/Hz (typ)

Analog modulation

Frequency bands¹

Band	Frequency range	N
1	100 kHz to < 250 MHz	1
2	250 to < 375 MHz	0.25
3	375 to < 750 MHz	0.5
4	750 to < 1500 MHz	1
5	1500 to < 3000.001 MHz	2
6	3000.001 to 6000 MHz	4

Frequency modulation⁴ (Option UNT)

- Max deviation: $N \times 10$ MHz (nom)
- Modulation frequency response [at 100 kHz deviation]

	1 dB bandwidth	3 dB bandwidth
DC/AC coupled	DC/5 Hz to 3 MHz (nom)	DC/5 Hz to 7 MHz (nom)

Phase modulation⁴ (Option UNT)

	Max dev	3 dB bandwidth
Normal BW	$N \times 5$ radians (nom)	DC to 1 MHz (nom)
High BW mode	$N \times 0.5$ radians (nom)	DC to 4 MHz (nom)

N5182A

Amplitude modulation⁵ (Option UNT)

- Maximum depth: 100%
- Modulation rate [3 dB BW]: DC/AC coupled: 0/5 Hz to 10 kHz (typ)

Wideband AM rates

- ALC on/off: DC/800 Hz to 50 MHz (nom)

Pulse modulation (Option UNU)⁶

- On/off ratio: > 80 dB (typ)
- Rise/fall time: < 50 ns (typ)
- Minimum width⁷: ≥ 500 ns
- Pulse repetition frequency⁷: DC to 2 MHz

Narrow pulse modulation (Option UNW)⁶

	500 MHz to 3.0 GHz	Above 3.0 GHz
On/off ratio	> 80 dB (typ)	> 80 dB (typ)
Rise/fall time	< 10 ns; 7 ns (typ)	< 10 ns; 7 ns (typ)
Minimum width⁷	≥ 20 ns	≥ 20 ns
Pulse repetition frequency⁷	DC to 5 MHz	DC to 10 MHz

Internal pulse generator (included with Option UNU or UNW)

- Square wave rate: 0.1 Hz to 10 MHz, 0.1 Hz resolution (nom)
- Pulse period: 30 ns (500 ns with UNU) to 42 seconds (nom)
- Pulse width: 20 ns (500 ns with UNU) to pulse period – 10 ns (nom)

Pulse train (Option 320)

- Number of pulse patterns: 2047
- On/off time range: 500 ns (UNU) or 20 ns (UNW) to 42 sec

Baseband generator (Options 651, 652, 654)

- Channels: 2 [I and Q]

	Clock rate	Bandwidth
Option 651	100 Sa/s to 30 MSa/s	24 MHz
Option 652	100 Sa/s to 60 MSa/s	48 MHz
Option 654	100 Sa/s to 125 MSa/s	100 MHz

Waveform switching speed

Type	Standard	Option UNZ
SCPI mode	≤ 5 ms (typ)	≤ 1.2 ms (typ)
List/step sweep mode	≤ 5 ms (typ)	≤ 900 μs (typ)

Arbitrary waveform memory

- Maximum playback capacity: 8 MSa, 64 MSa (Option 019)
- Maximum storage capacity including markers: 800 MSa

Multi-baseband generator synchronization

- Trigger repeatability: < 1 ns (nom)

AWGN (Option 403)

- Randomness: repetition period 313 x 10⁹ years

Custom modulation (Option 431)

- PSK: BPSK, QPSK, OQPSK, π/4DQPSK, 8PSK, 16PSK, D8PSK
- QAM: 4, 16, 32, 64, 128, 256
- FSK: 2, 4, 8, 16/MSK/ASK

Multitone and two-tone (Option 430)

- Number of tones: 2 to 64, with selectable on/off state per tone

Real-time phase noise impairments (Option 432)

- Create precise digital added phase noise impairments

3GPP W-CDMA distortion performance

Offset	Configuration	Option UNV ⁸	
		Spec	Typ
Adj (5MHz)	64 DPCH 1 carrier	-71 dBc	-73 dBc

Remote programming

- Interfaces: GPIB, 100BaseT LAN, LXI Class B, USB 2.0
- Control languages: SCPI Version 1997.0

Compatibility languages

- E4438C, E4428C, E442xB, E443xB, E8241A, 8648 Series, E8663B, and more...

Security (Option 006)

- Memory sanitizing, and display blanking

Weight

- ≤ 12.5 kg (27.5 lb.) net, ≤ 27.2 kg (60 lb.) shipping

Dimensions

- 88 mm H x 426 mm W x 432 mm L (3.5 in H x 16.8 in W x 17 in L)

Signal Creation Software

- N5182A-403** calibrated AWGN
- N5182A-430** multitone and two-tone
- N5182A-431** custom digital modulation
- N5182A-432** phase noise impairments

Also create reference signals: LTE, HSPA+, W-CDMA, GSM, WLAN, DVB-H, and more (For more details, see the Signal Studio section on page 203).

Ordering Information

Frequency

- N5182A-503** frequency range from 100 kHz to 3 GHz
- N5182A-506** frequency range from 100 kHz to 6 GHz

Performance enhancements

- N5182A-UNZ** fast switching
- N5182A-1EA** high output power
- N5182A-1EQ** low power (< -110 dBm)
- N5182A-UNU** pulse modulation
- N5182A-UNW** narrow pulse modulation
- N5182A-320** pulse train generator
- N5182A-UNT** AM, FM, phase modulation
- N5182A-006** instrument security
- N5182A-1ER** flexible reference input (1 – 50 MHz)
- N5182A-1EM** move RF output to rear panel 1
- N5182A-UK6** commercial calibration certificate with test data
- N5182A-099** expanded license key upgradeability
- N5182A-012** LO in/out for phase coherency

Vector-specific Options

- N5182A-651** internal baseband generator (30 MSa/s, 8 MSa)
- N5182A-652** internal baseband generator (60 MSa/s, 8 MSa)
- N5182A-654** internal baseband generator (125 MSa/s, 8 MSa)
- N5182A-019** increase baseband generator memory to 64 MSa
- N5182A-1EL** differential I/Q outputs
- N5182A-403** calibrated AWGN
- N5182A-UNV** enhanced dynamic range
- N5182A-430** multitone and two-tone
- N5182A-431** custom digital modulation
- N5182A-432** phase noise impairments
- N5182A-221-229** waveform license 5-packs 1 to 9 (purchase up to 9 packs for 45 Signal Studio waveforms)
- N5182A-250-259** waveform license 50-packs 1 to 10 (purchase up to 10 packs for 500 Signal Studio waveforms)

See the Signal Studio section on page 203 for Signal Studio software ordering information.

Accessories

- N5182A-1CM** rackmount kit
- N5182A-1CN** front handle kit
- N5182A-1CP** rackmount and front handle kit
- N5182A-1CR** rack slide kit
- N5182A-AXT** transit case
- N5182A-800** customer service kit front panel connector configuration (parts kit enables owners to repair the MXG on site, includes internal replacement parts, tools, and a calibrated RF module.)
- N5182A-801** customer service kit rear panel (1EM) RF connector configuration (parts kit enables owners to repair the MXG on site, includes internal replacement parts, tools, and a calibrated RF module.)

¹ Time from receipt of SCPI command or trigger signal to within 0.1 ppm of final frequency or within 100 Hz, whichever is greater, and amplitude settled to within 0.2 dB
² Time from receipt of SCPI command or trigger signal to amplitude settled within 0.2 dB
³ Or maximum specified output power, whichever is lower
⁴ N is a factor used to define certain specifications in the document
⁵ AM is specified at carrier frequencies from 500 kHz to 3 GHz, power levels ≤ ±4 dBm, and with ALC on and envelope peaks within ALC operating range (-20 dBm to maximum specified power, excluding step-attenuator setting)
⁶ Pulse specifications apply to frequencies > 500 MHz. Operable down to 10 MHz
⁷ ALC off with power search
⁸ Frequency range 1800 to 2200 MHz

Web Link

www.agilent.com/find/mxg

- Create Agilent-validated and performance-optimized reference signals
- Configure signals in an easy-to-use, application-specific graphical interface
- Take advantage of the broad application coverage
- Scale capability and performance to meet your specific test needs
- Validate 3rd party interoperability

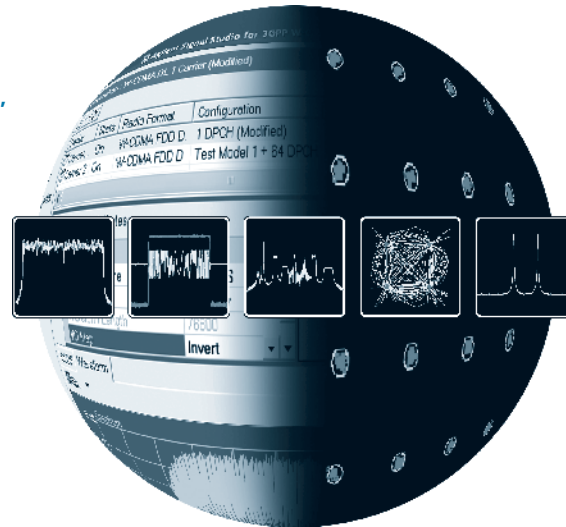

- N7600B
- N7601B
- N7602B
- N7606B
- N7609B
- N7611B
- N7612B
- N7613A
- N7615B
- N7616B
- N7617B
- N7619A
- N7620A
- N7621A
- N7621B
- N7622A
- N7623B
- N7624B
- N7625B
- E4438C-407
- E4438C-419
- E4438C-SP1
- E8267D-SP1



Cellular communications

3GPP LTE FDD/TDD
3GPP W-CDMA
HSPA/HSPA+
TD-SCDMA
cdmaOne
cdma2000/1xEV
GSM/EDGE/EDGE Evo



Wireless connectivity

802.11 WLAN (a/b/g/p/j/n)
802.16e mobile WiMAX
802.16d fixed WiMAX
Bluetooth
802.15 MB-OFDM UWB



Audio/video broadcasting

DVB-C/H/S/S2/T/T2
J.83 A/B(DOCSIS DS)/C
ISDB-T
ATSC
DTMB
CMMB
T/S-DMB
FM stereo/RDS
DAB, DAB+



Detection, positioning, tracking, and navigation

Pulse building
Multi-satellite GPS
GPS scenario generator

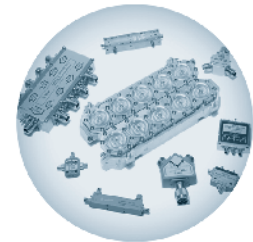

General RF and microwave

Toolkit
Enhanced multitone
Noise power ratio

Signal Studio Software

Agilent Signal Studio is a suite of flexible, easy-to-use, signal creation software that will cut the time you spend on signal simulation. And, with a demonstrated first-to-market track record, Agilent's signal creation software helps you stay at the forefront of product development as wireless systems continue to evolve.

Cellular Communications

Signal Studio has built a solid reputation as the benchmark test stimulus in the cellular communications industry with a comprehensive suite of standards-compliant solutions for existing and evolving 2G, 3G and 3.9G cellular communications systems. As technology advances to support more voice capacity, broadband data and mobile video services, Signal Studio is advancing to enable you to continue tackling increasingly complex design and manufacturing test challenges.

Wireless Networking

The race to deliver broadband wireless connectivity is accelerating and Agilent is working hard to help you stay ahead of the pack by providing signal creation solutions early in the technology lifecycle. As emerging and rapidly evolving wireless connectivity standards advance to support higher data rates, Signal Studio is pushing ahead to provide you with the tools you need to optimize your designs and ramp production.

Audio/Video Broadcasting

Broadband communications systems and modern handheld wireless devices are making mobile video services a reality. As satellite, terrestrial, cable and mobile audio/video broadcasting systems and standards press forward to support higher bit rates for high definition (HD) video, more robust quality of service, and mobility, you can count on Signal Studio to enable cost effective design validation and manufacturing.

Detection, Positioning, Tracking, and Navigation

Modern detection, positioning, tracking and navigation systems need advanced signal creation tools to simulate realistic operating environments for receiver verification, such as antenna scan pulse patterns and GPS signals with moving scenarios. The racks of test equipment previously required to develop and manufacture radar and global navigation satellite systems can now be cost effectively replaced by commercial off-the-shelf (COTS) instruments and Signal Studio.

General Purpose

Signal Studio for general purpose RF and microwave test applications shortens development time by simplifying your test setup and lowering the overall cost of test. Agilent provides innovative signal creation and performance optimization software tools for use in development and manufacturing of RF and microwave transceivers and the components that comprise them. Create multitone and NPR signals for distortion test and apply signal corrections to minimize non-linear distortion of the test stimulus to reduce your measurement uncertainty.

Product Summary

Model #	Signal Studio	N5182A MXG N5162A MXG ATE	E4438C ESG	E8267D PSG	N5106A PXB ¹	DigRF V3 and V4 solutions ⁵	N8300A wireless test set	Free trial license
---------	---------------	------------------------------	---------------	---------------	----------------------------	--	--------------------------------	-----------------------



Cellular communications

N7624B	3GPP LTE FDD	•	•		•	•		•
N7625B	3GPP LTE TDD	•	•		•	•		•
N7621A	N7600B 3GPP W-CDMA	•	•	•	•	•		•
N7621B	E4438C-419 3GPP W-CDMA HSPA		•					
N7623B	N7602B GSM/EDGE	•	•	•	•	•		•
N7624B	N7601B 3GPP2 CDMA	•	•	•		•		•
N7625B	N7612B TD-SCDMA	•	•		•			•

Wireless connectivity

N7615B	802.16 WiMAX	•	•	•	•	•	•	•
N7613A	802.16-2004 WiMAX	•	•	•				•
N7617B	802.11 WLAN	•	•	•	•			•
N7606B	Bluetooth	•	•	•				•
N7619A	MB-OFDM UWB			• ²				

Audio/video broadcasting

N7623B	Digital video	•	•	•	•			•
N7616B	T-DMB	•	•					•
E4438C-407	S-DMB		•					
N7611B	Broadcast radio	•	•					•

Detection, positioning, tracking & navigation

N7609B	Global navigation satellite systems				•			
N7620A	Pulse building		•	• ³				•

General RF & microwave

N7621A	Multitone distortion (wideband)			• ⁴				
N7621B	Multitone distortion (narrowband)	•	•	•				•
E4438C-SP1	Jitter injection		•					
E8267D-SP1	Jitter injection			•				
N7622A	Toolkit	•	•	•				

¹ Free trial not currently available on N5106A PXB, 16800/16900 logic analyzers, N5443A/44A RDX, N8300A, N603xA PXI ARB, and N8240A/41A LXI ARB

² Requires the N6030A/31A PXI arbitrary waveform generator

³ Also supports the N6030A/31A PXI and N8240A/41A LXI arbitrary waveform generator

⁴ Requires the N603xA PXI or N8240A/41A LXI arbitrary waveform generator

⁵ All compatible Signal Studio products support 16800/16900 logic analyzers. N7624B and N7625B also support the N5343A/44A RDX solution

Web Link

www.agilent.com/find/signalstudio

- Up to 120 MHz baseband generation, real-time fading, and signal capture bandwidth
- 512 Msa playback and signal capture memory per channel
- Up to six baseband generators and eight faders for interference, diversity, and MIMO test (1x2, 1x4, 2x1, 2x2, 2x4, 4x2)
- Select and customize standard-based channel models, calculate correlation coefficients based on antenna setup, and create a custom correlation matrix
- LTE, HSPA, W-CDMA, GSM/EDGE, TD-SCDMA, Mobile WiMAX, WLAN, digital video, broadcast radio, and GPS
- Connect with SystemVue software or play back your own MATLAB waveforms
- Connect to the Agilent 8960 Series 10 (E5515C) wireless communication test set for real-time fading

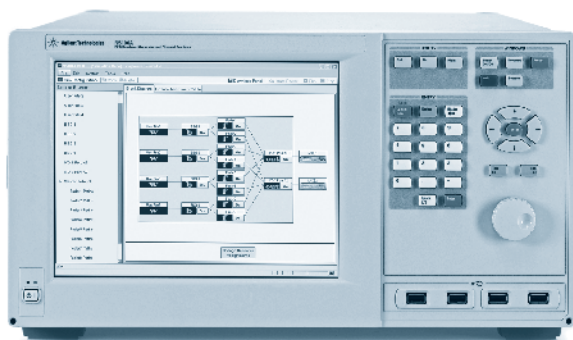

N5106A PXB baseband generator and channel emulator

Comprehensive Diagnostics for Receiver Signal Processing

Keep pace with rapid design changes using the PXB baseband generator and channel emulator to test receiver signal processing to standards and beyond. The PXB is the only instrument that combines multi-format baseband generation, real-time fading, and signal capture in a single box. At any stage of the R&D lifecycle, you can use the PXB to quickly diagnose and troubleshoot designs.

Count on the PXB to:

- Minimize design uncertainty, with the most flexibility to test beyond standards requirements
- Reduce the time, cost, and complexity of system setup and calibration
- Maximize the value of your investment through higher instrument utilization and easy upgrades

Specifications

- Maximum sample rate/bandwidth: 150 MHz max sample rate, 120 MHz max bandwidth
- Waveform playback and signal capture memory size: 512 Msamples
- Type (arb only or arb realtime): arb + realtime

Ordering Information

- N5106A-611** 1 DSP block on 1 baseband card
- N5106A-612** 2 DSP blocks on 1 baseband cards
- N5106A-613** 3 DSP blocks on 2 baseband cards
- N5106A-614** 4 DSP blocks on 2 baseband cards
- N5106A-615** 5 DSP blocks on 3 baseband cards
- N5106A-616** 6 DSP blocks on 3 baseband cards
- N5106A-617** 7 DSP blocks on 4 baseband cards
- N5106A-618** 8 DSP blocks on 4 baseband cards
- N5106A-619** 9 DSP blocks on 5 baseband cards
- N5106A-620** 10 DSP blocks on 5 baseband cards
- N5106A-621** 11 DSP blocks on 6 baseband cards
- N5106A-622** 12 DSP blocks on 6 baseband cards
- N5106A-632** 2 I/O ports – 2 analog I/Q out and 2 digital I/O on 1 I/O card
- N5106A-634** 4 I/O ports – 4 analog I/Q out and 4 digital I/O on 2 I/O card
- N5106A-636** 6 I/O ports – 6 analog I/Q out and 6 digital I/O on 3 I/O card
- N5106A-EFP** baseband generation
- N5106A-QFP** fading with SISO channel models
- N5106A-RFP** mobile WiMAX channel models
- N5106A-TFP** LTE channel models
- N5106A-FFP** signal capture
- N5106A-JFP** calibrated AWGN
- N5106A-8FP** connect to E5515C (8960)
- N5106A-181** USB enabled keyboard, mouse, and DVD-ROM drive

Web Link

www.agilent.com/find/pxb

N5102A

Provides either digital inputs or digital outputs flexible data formats

- Variable 4 to 16 bit words on dual 16 bit buses
- Serial, parallel, and parallel interleaved (DDR)
- 2's complement and binary offset numbering
- Selectable MSB or LSB
- Digital IQ or digital IF¹

Flexible clocking

- Up to 400 MHz in serial mode, 100 MHz in parallel mode
- Provision for internal, external, or device clocking
- Independent data input and output rates
- Adjustable clock phase and skew
- Up to four clocks per sample²

Flexible signal interface

- Low voltage TTL, CMOS (1.5 V, 1.8 V, 2.5 V, 3.3 V) and LVDS
- Single cable connects signal generator and interface module
- Interchangeable break-out boards simplify device connection
- Simple user interface

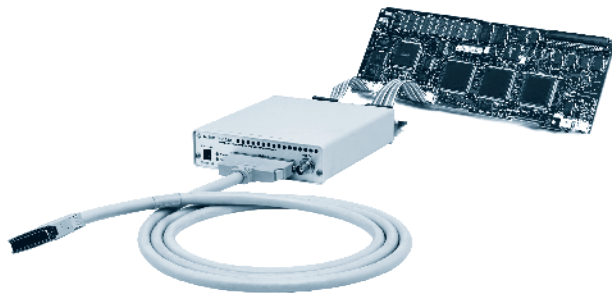

The N5102A digital signal interface module provides flexible and reliable digital interfaces to the N5106A PXB baseband generator and channel emulator, E4438C ESG and E8267D PSG vector signal generators to interact with your DUT at the digital plane. The interface module adapts to your device with the logic type, data format, clock features, and signaling you require. With its three-meter extension cable and a selection of connector types, the interface module connects easily to your device, in most cases eliminating the need for custom fixtures. When connected to the N5106A PXB, E4438C ESG or E8267D PSG it performs digital output and input functions. In the output mode, you can deliver realistic complex-modulated signals such as LTE, HSPA, W-CDMA, 1xEV-DO, custom pulses, WLAN, digital video, GPS and many others directly to your digital devices and subsystems. In the input mode, the interface module ports your digital input to the these platforms' baseband system, providing a quick and easy way of up-converting to calibrated analog I/Q, RF or μ W frequencies.

Specifications

Data

Digital data format

- User-selectable: 2's complement or binary offset, IQ (I, I-bar, Q, Q-bar) or digital IF¹ (real, imaginary)

Data port

- Dual 16-bit data buses support parallel, parallel IQ interleaved, parallel QI interleaved, or serial port configuration

(Device interface) connector

144-pin Tyco Z-Dok+ connects to break-out boards (included) that interface with the following connector types:

- 68-pin SCSI
- 38-pin dual AMP Mictor
- 100-pin dual Samtec
- 20-pin dual 0.1 inch headers
- 40-pin dual 0.1 inch headers
- The Z-Dok+ mating connector is also included for custom interfacing

Logic types

- Single-ended: LVTTTL, 1.5 V CMOS, 1.8 V CMOS, 2.5 V CMOS, 3.3 V CMOS
- Differential: LVDS

Data output resampling

- PXB/ESG/PSG baseband output is resampled to the arbitrary clock rate set by the user via real-time curve-fit calculations

Clock

Clock input

- User selectable: internal clock, device under test DUT clock (device interface connector), or external clock (ext clock in connector) SMA, 50 ohm, 0 dBm nominal, 1 to 400 MHz

Clock output

- User selectable: device interface connector, or clock out connector SMA, 2 Vpp into load > 5 K ohm from 1 to 100 kHz, 400 mVpp into 50 ohm load from 100 kHz to 400 MHz

Sample rate

- User-selectable up to a maximum 100 MHz, but limited by other user settings
- In serial mode, the maximum rate is 400 MHz/word size
- Tables 4-1 through 4-6 in the user's guide (N5102-90001) supply a complete list of rates for every case

Bit rate

- Serial: up to 400 MHz per serial line (400 Mbps LVDS) or 150 MHz per serial line (150 Mbps (CMOS/LVTTTL)), 32 lines available
- Parallel: up to 100 MHz x word size (1.6 Gbps LVDS, CMOS and LVTTTL) per parallel bus, 2 parallel buses available

Clocks per sample

- In parallel output mode, the data sample can be held for 1, 2 or 4 clock cycles

Clock to data skew

- Coarse adjustment in 90° steps from 0 to 270°; fine-adjustment in increments of 100 ps up to 5 ns

Clock polarity

- Clock signals may be inverted

Frequency reference input

- 1 to 100 MHz BNC, 50 ohm, 3 dBm \pm 6 dB

Power supply (included)

- Input: 100 to 240 VAC, 0.7 A, 50 to 60 Hz
- Output: 5 V, 4 A DC

Ordering Information

N5102A digital signal interface module

¹ IF is available only in output mode

² Multiple clocks/sample only available in parallel and parallel interleaved output mode

Web Link

www.agilent.com/find/n5102a

Discontinued Products Cross Reference Table

This table contains recommended replacement products.

For more detailed information regarding replacement performance please see the pages listed below.

Discontinued product	Recommended replacement product	Options	Page
E8241A PSG-L Series performance signal generator, 20 GHz	E8257D ¹	520	181
E8244A PSG-L Series performance signal generator, 40 GHz	E8257D ¹	540	181
E8251A PSG-A Series performance signal generator, 20 GHz	E8257D	520, UNT, UNW	181
E8254A PSG-A Series performance signal generator, 40 GHz	E8257D	540, UNT, UNW	181
E8247C PSG CW signal generator	E8257D ¹		181
E8257C PSG analog signal generator	E8257D	UNT, UNW	181
E8267C PSG vector signal generator	E8267D	UNT, UNW	195
83620A Synthesized sweeper, 10 MHz to 20 GHz	E8257D	520, 007, UNT ² , UNU ³	181
83620B Synthesized swept – signal generator, 0.01 to 20 GHz	E8257D	520, 007, UNT ² , UNU ³	181
83622A Synthesized sweeper, 2 to 20 GHz	E8257D	520, 007, UNT ² , UNU ³	181
83622B Synthesized swept – signal generator, 2 to 20 GHz	E8257D	520, 007, UNT	181
83623A Synthesized sweeper, 10 MHz to 20 GHz, high power	E8257D	520, 007, UNT ² , UNU ³	181
83623B High power swept – signal generator, 0.01 to 20 GHz	E8257D	520, 007, UNT ² , UNU ³	181
83623L Synthesized swept – CW generator, 10 MHz to 20 GHz	E8257D ¹	520, 007	181
83624A Synthesized sweeper, 2 to 20 GHz, high power	E8257D	520, 007, UNT ² , UNU ³	181
83624B High power swept – signal generator, 2 to 20 GHz	E8257D	520, 007, UNT ² , UNU ³	181
83630B Synthesized swept – signal generator, 0.01 to 26.5 GHz	E8257D	532, 007, UNT ² , UNU ³	181
83630L Synthesized swept – CW generator, 10 MHz to 26.5 GHz	E8257D ¹	532, 007	181
83640A Synthesized sweeper, 10 MHz to 40 GHz	E8257D	540, 007, UNT ² , UNU ³	181
83640B Synthesized swept – signal generator, 0.01 to 40 GHz	E8257D	540, 007, UNT ² , UNU ³	181
83640L Synthesized swept – CW generator, 10 MHz to 40 GHz	E8257D ¹	540, 007	181
83650B Synthesized swept – signal generator, 0.01 to 50 GHz	E8257D	550, 007, UNT ² , UNU ³	181
83650L Synthesized swept – CW generator, 10 MHz to 50 GHz	E8257D ¹	550, 007	181
E4400B ESG-A Series analog signal generator, 1 GHz	N5181A	501, UNT, UNU, 1EQ	189
E4420B ESG-A Series analog signal generator, 2 GHz	N5181A	503, UNT, UNU, 1EQ	189
E4421B ESG-A Series analog signal generator, 3 GHz	N5181A	503, UNT, UNU, 1EQ	189
E4422B ESG-A Series analog signal generator, 4 GHz	N5181A	506, UNT, UNU, 1EQ	189
E4423B ESG-AP Series analog signal generator, 1 GHz	E4428C	503	187
E4424B ESG-AP Series analog signal generator, 2 GHz	E4428C	503	187
E4425B ESG-AP Series analog signal generator, 3 GHz	E4428C	503	187
E4426B ESG-AP Series analog signal generator, 4 GHz	E4428C	506	187
E4430B ESG-D Series vector signal generator, 1 GHz	N5182A	503, UNT, UNU, 1EQ	201
E4431B ESG-D Series vector signal generator, 2 GHz	N5182A	503, UNT, UNU, 1EQ	201
E4432B ESG-D Series vector signal generator, 3 GHz	N5182A	503, UNT, UNU, 1EQ	201
E4433B ESG-D Series vector signal generator, 4 GHz	N5182A	506, UNT, UNU, 1EQ	201
E4434B ESG-DP Series vector signal generator, 1 GHz	E4438C	501, UNJ	199
E4435B ESG-DP Series vector signal generator, 2 GHz	E4438C	502, UNJ	199
E4436B ESG-DP Series vector signal generator, 3 GHz	E4438C	503, UNJ	199
E4437B ESG-DP Series vector signal generator, 4 GHz	E4438C	506, UNJ	199
8645A Frequency-agile signal generator, 1 GHz or 2 GHz	N5181A E4428C	501/503, UNZ 503, UNB	189 187
8644B High-performance signal generator, 1 GHz or 2 GHz	E8663D	503, UNT, UNU, UNY	185
8648A Synthesized signal generator, 100 kHz to 1 GHz	N5181A	501, UNT, UNU, 1EQ	189
8648B Synthesized signal generator, 9 kHz to 2 GHz	N5181A	503, UNT, UNU, 1EQ	189
8648C Synthesized signal generator, 9 kHz to 3.2 GHz	N5181A	506, UNT, UNU, 1EQ	189
8648D Synthesized signal generator, 9 kHz to 4 GHz	N5181A	506, UNT, UNU, 1EQ	189
8662A High-performance signal generator, 1.2 GHz	E8663D	503, UNT, UNU, UNX	185
8663A High-performance signal generator, 2.5 GHz	E8663D	503, UNT, UNU, UNX	185
8664A High-performance signal generator, 3 GHz	E8663D	503, UNT, UNW, UNX	185
8665B High-performance signal generator, 6 GHz	E8663D	509, UNT, UNW, UNX	185

¹ For CW only capability the E8257D is ordered without analog modulation options

² To add scan modulation to the E8257D, Option 1SM must be included

³ For equivalent operation below 3.2 GHz, Option UNW must be substituted for Option UNU on the E8257D



Function/arbitrary waveform generator family

Find Your Fit in the Agilent Technologies Family

In addition to producing sine waves accurate in frequency and amplitude Agilent function generators are versatile signal sources that can produce all of the following waveforms: square, triangle, ramp and pulse. Tuning is continuous over wide bands, and many models can modulate these waveforms and sweep them across a range of frequencies. Agilent function generators use frequency syntheses techniques to generate their outputs. There are many applications for these general-purpose signal sources including speed sensor characterization, and design and test of communications receivers.

You can create complex signals for your unique applications using the Agilent function generators programmable arbitrary waveforms. Waveforms can be created from the front panel or on a PC and then downloaded. A typical use for arbitrary waveforms is to simulate specific ECG waveforms to verify that an electronic hospital patient monitor responds in the proper manner.

From complex signal to simple waveforms, there is an Agilent function generator that is right for the job. See the table for additional detail.

New 33500 Series Function/Arbitrary Waveform Generators

The 33500 Series offers new revolutionary signal generation that provides superior signal integrity, true pint-by-point arbitrary waveforms, and dual channel coupling for applications spanning R&D to manufacturing. The 33500 Series includes a 1 & 2 channel model with 30 MHz sine, square and pulse waves, 250 M samples/second and 16-bit sampling. The advanced design of sweep control and arbitrary waveform technology features are unmatched by other function/arbitrary waveform generators. Setup and control are even easier using the large, high-resolution color display. Fast programming speeds are achieved via 10/100 LAN, USB 2.0 and GPIB interfaces and SCPI compatible commands. For more information go to page 210.

81150A Pulse Function Arbitrary Noise Generator

The Agilent 81150A pulse function arbitrary noise generator is a 4-in-1 device with up to 120 MHz pulse and pattern generation, 240 MHz sine waves and 2 GSa/s arbitrary waveform generation. The digital noise provides signal repetition time of up to 26 days and FM, AM, PW, PWM, FSK modulation capabilities up to 10 MHz. More information on page 215.

Prominent 33220A, 33210A and 33250A Function/Arbitrary Waveform Generators

The 33220A (20 MHz), 33210A (10MHz) and 33250A (80MHz) function/arbitrary waveform generators use direct digital synthesis (DDS) techniques to create a stable, accurate output signal for clean, low distortion sine waves. The benefits are apparent in every signal you produce, from the sine wave frequency accuracy to the fast rise/fall times of square waves, to the ramp linearity. Complex custom waveforms with 14-bit resolution, and sample rates of 50 MSa/s are easy to create using the 33220A/210A function generators. The 33250A provides 12-bit resolution and sample rates of 200 MSa/s for arbitrary waveforms. For more information see selection guide on page 209.

81180A High-Bandwidth Arbitrary Waveform Generator

Optimized for specific communications applications such as I/Q modulation, the 81180A provides up to 2 GHz IQ modulation bandwidth. With 12 bits resolution and up to 4.2 GS/s sampling rate, the 81180A has excellent dynamic range and delivers reliable and repeatable measurements. For more information see page 213.

M9330A Series, N8241A, and N8242A Wideband Arbitrary Waveform Generators

The M9330A (PXI) Series and N8241A and N8242A (LXI) arbitrary waveform generators deliver high resolution waveforms for wideband communication systems. With up to 500 MHz of bandwidth per channel and two channels, these products deliver unprecedented performance at 10 bits or 15 bits of resolution and 1.25 GS/s or 625 MS/s sample rate. For more information see page 212.

N5106A PXB Baseband Generator and Channel Emulator

The N5106A PXB baseband generator and channel emulator tests receiver signal processing to standards and beyond. The PXB combines multi-format baseband generation, real-time fading and signal capture in a single box. At any stage of the R&D lifecycle, you can use the PXB to quickly diagnose and troubleshoot designs. Emulate standard signals such as LTE, digital video, and GPS using Signal Studio software. For more information see page 205.

U2761A USB Modular Function/Arbitrary Waveform Generator

The 20 MHz, U2761A modular function/arbitrary waveform generator offers 11 standard waveforms plus pulse and arbitrary waveforms generation capabilities in a small compact package. Agilent measurement manager (AMM) software is bundled with the product providing a familiar front panel interface for quick setup. The U2761A can function as a standalone module or as a modular device in the U2781A USB modular product chassis. For more information, see selection guide below.

Selection Guide for Agilent General Purpose Function/Arbitrary Waveform Generators

	U2761A	33210A/33220A	33250A	33521A/33522A	81150A
Frequency range (sine, square)	1 μ Hz to 20 MHz	1 μ Hz to 10 MHz (33210A) 1 μ Hz to 20 MHz (33220A)	1 μ Hz to 80 MHz	1 μ Hz to 30 MHz	1 μ Hz to 240 MHz
Number of channels	1 channel	1 channel	1 channel	1 channel (33521A) 2 channels (33522A)	1 channel (81150A-001) 2 channels (81150A-002)
Key features	USB-based modular function generator with arbitrary waveform and pulse generation capability	Provides stable, accurate output signal for clean, low distortion sine waves. 14-bit resolution	TCXO timebase provides frequency accuracy of 1 ppm for demanding applications 12-bit resolution	Unmatched signal integrity, true point-by-point arbs, and dual channel coupling 16-bit resolution	High precision pulse generator enhanced with versatile function/arbitrary waveform generator for ideal and real world signals
Standard waveforms	Sine, square, ramp, triangle, pulse, DC	Sine, square, pulse, triangle, ramp, noise, sine(x)/x, exponential rise and fall, cardiac, DC volts	Sine, square, pulse, triangle, ramp, noise, sine(x)/x, exponential rise and fall, cardiac, DC volts	Sine, square, ramp, pulse, triangle, Gaussian noise, PRBS (pseudorandom binary sequence), DC, cardiac, exponential fall, exponential rise, Gaussian pulse, haversine, lorentz, negative ramp, sinc	Sine, pulse, square, triangle, ramp, sin(x)/x, exponential rise and fall; cardiac, noise with selectable crest factor and 26 days signal rate repetition
Pulse	5 MHz with variable period and pulse width	5 MHz, variable edge time	50 MHz, variable edge time	30 MHz, independent leading and trailing edge time	1 μ Hz to 120 MHz, variable rise/fall time
Arbitrary waveforms	2 to 64 K points (2 M points with Option 1FP)	2 to 64 K points (Optional for 33210A)	1 to 64 K points	8 to 1 MSa (16 MSa with Option 002) with multi-segment sequencing	512 k samples per channel
Sample rate	50 MSa/s	50 MSa/s	200 MSa/s	1 μ Sa/s to 250 MSa/s, 1 μ Sa/s resolution	2 GSa/s
Modulation	AM, FM, PM, ASK, FSK, PSK	AM, FM, PM, FSK, PWM (all internal/external (AM, FM, FSK for 33210A))	AM, FM, FSK (all internal/external)	AM, FM, PM, FSK, BPSK, PWM, Sum (all internal/external)	AM, FM, PM, PWM FSK
Sweep	Linear or logarithmic	Linear or logarithmic; up or down	Linear or logarithmic; up or down	Linear, logarithmic, list (up to 128 user-defined frequencies)	Linear or logarithmic up or down
Burst	N/A	Gated, N-cycle	Gated, N-cycle	Gated, N-cycle	Gated, N-cycle
External clock reference (can also be used to create precise phase offsets or to phase-lock two generators)	External lock range: 10 MHz \pm 170 Hz	Optional External lock range: 10 MHz \pm 500 Hz Internal frequency: 10 MHz	External lock range: 10 MHz \pm 35 kHz Internal frequency: 10 MHz	External lock range: 10 MHz \pm 20 Hz Internal frequency: 10 MHz \pm 1 Hz	10 MHz
Connectivity (IntuiLink SW included)	USB	GPIB, USB, LAN	GPIB, RS-232	LAN & USB 2.0. GPIB (optional)	GPIB, LAN, USB, IntuiLink SW

Web Link

www.agilent.com/find/functiongenerators

33521A
33522A

- 1 and 2 channel 30 MHz, 250 MSa/s, 16-bit
- Advanced sweep control, advanced arbitrary waveform technology
- 1 M-point/ch waveform memory (16 M Option 002)
- 512 step arbitrary waveform sequencing
- < 30 ps jitter – all signals
- Dual channel mode – independent or coupled channels
- Built-in graphical editor application

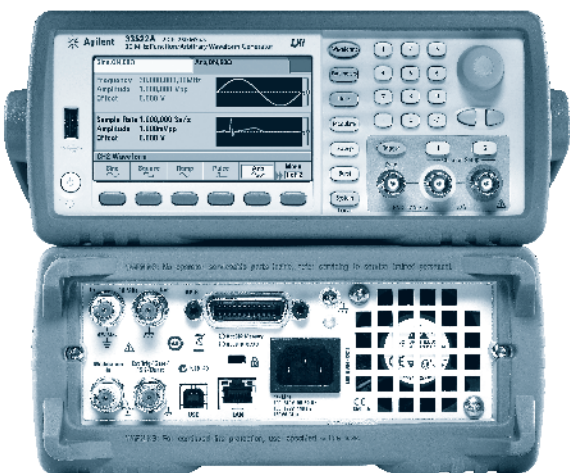

33522A, 2 channel 30 MHz function generator

33500 Series Function/Arbitrary Waveform Generators

The 1 and 2 channel 33521A and 33522A function/arbitrary waveform generators provide signals such as sine, square, ramp and noise, for qualifying designs and provide signals for stimulus in test systems. The instruments pulse width modulation (PWM) capability is powerful when controlling analog circuits with a microprocessor's digital outputs. PWM is used in applications including engine control, power management and supply as well as analog translation of digital audio. The 33522A 2-channel function generator uses coupled 2-channel arbitrary waveforms to apply a two-tone test signal to exercise the response of a linear amplifier. Many baseband wireless communications protocols require a 2-channel modulation, such as the 33522A can provide, to source signals such as I & Q.

The 33521A and 33522A are the first 30 MHz function/arbitrary waveform generators in their class providing functions, pulses, and point-by-point arbitrary waveforms in one instrument. They provide you with the ability to create many arbitrary waveforms without a PC, using the embedded waveform builder. The revolutionary signal generation provided by these instruments offers the highest signal fidelity with full-bandwidth pulses, and real point-by-point arbitrary waveforms.

Specifications

Instrument characteristics

33521A: 1-channel
33522A: 2-channel

Waveforms

- Standard: sine, square, ramp, pulse, triangle, Gaussian noise, PRBS (pseudorandom binary sequence), DC
- Built-in arbitrary: cardiac, exponential fall, exponential rise, Gaussian pulse, haversine, lorentz, negative ramp, sinc
- User-defined arbitrary: up to 1 MSa (16 MSa with Option 002) with multi-segment sequencing

Modulation types and operating modes

- Modulation types: AM, FM, PM, FSK, BPSK, PWM, Sum (carrier + modulation)
- Operating modes: continuous, modulate, frequency sweep, burst (counted or gated)

Waveform characteristics

Sine

- Frequency range: 1 μ Hz to 30 MHz, 1- μ Hz resolution
- Amplitude flatness (spec) (relative to 1 kHz):
 - < 100 kHz: ± 0.10 dB
 - 100 kHz to 5 MHz: ± 0.15 dB
 - 5 to 20 MHz: ± 0.30 dB
 - 20 to 30 MHz: ± 0.40 dB
- Harmonic distortion (typ):
 - < 20 kHz: < -70 dBc
 - 20 to 100 kHz: < -65 dBc
 - 100 kHz to 1 MHz: < -50 dBc
 - 1 to 20 MHz: < -40 dBc
 - 20 to 30 MHz: < -35 dBc
- THD (typ): 20 Hz to 20 kHz: $< 0.04\%$
- Non-harmonic spurious (typ):
 - Standard: < -75 dBc, increasing +20 dB/decade above 2 MHz
 - Option 010: < -75 dBc, increasing +20 dB/decade above 10 MHz
- Phase Noise (SSB) (typ)

	Standard	Option 010
1 kHz offset	-105 dBc/Hz	-110 dBc/Hz
10 kHz offset	-115 dBc/Hz	-125 dBc/Hz
100 kHz offset	-125 dBc/Hz	-135 dBc/Hz

Arbitrary waveform characteristics

General

- Waveform length: 8 to 1 MSa (16 MSa with Option 002) in increments of 1
- Sample rate: 1 μ Sa/s to 250 MSa/s, 1- μ Sa/s resolution
- Voltage resolution: 16 bits
- Bandwidth (-3 dB, nom):
 - Filter off: 40 MHz
 - "Normal" filter on: 0.27 x (sample rate)
 - "Step" filter on: 0.13 x (sample rate)
- Rise & fall time: 0.35/bandwidth (10 ns min) with "normal" or "step" filter on
- Settling time (typ): < 200 ns to 0.5% of final value
- Jitter (typ)
 - Filter off: < 40 ps
 - "Normal" or "step" filter on: < 5 ps

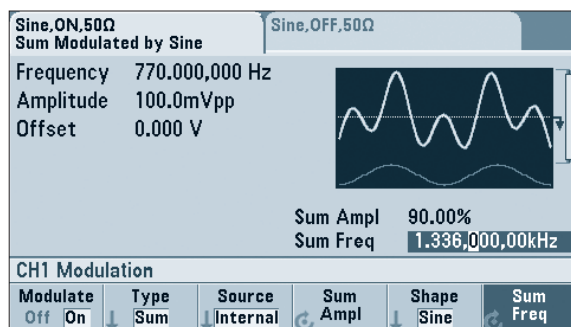

33521A/33522A display output: sum modulation used to create 2-tone telecom signals

Waveform sequencing

- Operation: individual arbitrary waveforms (segments) can be combined into user-defined lists (sequences) to form longer, more complex waveforms. Each sequence step specifies whether to repeat the associated segment a certain number of times, to repeat it indefinitely, to repeat it until a Trigger event occurs, or to stop and wait for a Trigger event. Additionally, the behavior of the Sync output can be specified in each step. To improve throughput, up to 32 sequences totaling of up to 1024 segments can be pre-loaded into volatile memory
- Segment length: 8 to 1 MSa (16 MSa with Option 002) in increments of 1
- Sequence length: 1 to 512 steps
- Segment repeat count: 1 to 1×10^6 , or infinite

Other specifications are the same as in the GENERAL section above

Output characteristics

Isolation

- Outputs: connector shells for Ch 1, Ch 2, Sync, and Mod In are connected together but isolated from the instrument's chassis. Maximum allowable voltage on isolated connector shells is ± 42 Vpk

Signal output

- Output impedance (nom): 50 Ω
- On, off, inverted: user-selectable for each channel
- Voltage limit: user-definable VMAX and VMIN safety limits
- Overload protection: short-circuit protected; output turns off automatically when an overload is applied

Amplitude

- Range:
 - 1 mVpp to 10 Vpp into 50 Ω
 - 2 mVpp to 20 Vpp into open circuit
- Resolution: 4 digits
- Units: Vpp, Vrms, or dBm, selectable
- Accuracy (spec): $\pm 1\%$ of setting ± 1 mVpp at 1 kHz

DC offset

- Range [5]:
 - $\pm (5$ VDC – Peak AC) into 50 Ω
 - $\pm (10$ VDC – Peak AC) into open circuit
- Resolution: 4 digits
- Units: VDC
- Accuracy (spec): $\pm 1\%$ of offset setting $\pm 0.25\%$ of amplitude setting ± 2 mV

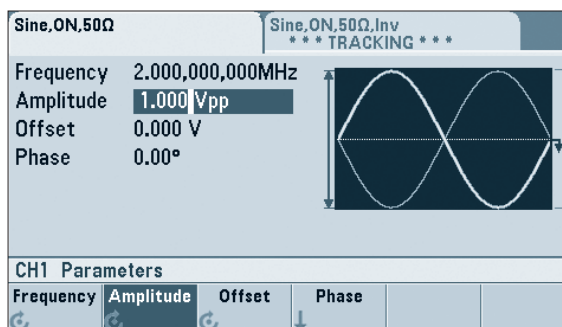

33522A display output: dual channel tracking used to create a differential output

Frequency accuracy

- Standard (TCXO) (spec):
 - 1 Year, 23 ± 5 °C: ± 1 ppm of setting ± 15 pHz
 - 1 Year, 0 to 55 °C: ± 2 ppm of setting ± 15 pHz
- Option 010 (OCXO) (spec):
 - 1 Year, 0 to 55 °C: ± 0.1 ppm of setting ± 15 pHz

2-channel characteristics (33522A only)

- Operating modes: independent, coupled parameter(s), combined (Ch 1 + Ch 2), or differential (Ch 2 = –Ch 1)
- Parameter coupling: none, frequency (ratio or difference) and/or amplitude and DC offset
- Relative phase: 0° to 360°, 0.1° resolution
- Skew (typ): < 200 ps
- Crosstalk (typ): < –85 dB

Ordering Information

- 33521A** 1-channel function/arbitrary waveform generator
- 33522A** 2-channel function/arbitrary waveform generator
- 33522A-002** increases arbitrary waveform memory to 16 MSa/channel
- 33522A-010** high-stability frequency reference
- 33522A-400** GPIB interface

Web Link

www.agilent.com/find/33500

M9330A
N8241A

- 1.25 GS/s sample rate
- 15 bit vertical resolution
- Dual channel, differential outputs
- 16 MS waveform memory
- Multi-module synchronization
- Multiple programmatic interfaces



M9330A



N8241A

Frequency reference

- Input drive level
 - +2 to +12 dBm into 50 ohms (+2 dBm nominal) waveform length
 - 8 MS per channel (16 MS with Option 016)
- Minimum waveform length: 128 samples
- Waveform granularity: 16 samples
- Segments: 1 to 256 k unique segments can be defined consisting of waveform start and stop addresses, repetitions, and marker enable flags
- Sequences: up to 256 k total unique waveform sequences can be defined. A sequence is a contiguous series of waveform segments

External triggers

- Number of inputs: 5 each (4 SMB female front panel connectors plus one software trigger)
- External markers: markers can be defined for each waveform segment
- Number of outputs: 4 each (SMB female)
- Module synchronization: supports system scaling for any number of arbitrary waveform generator modules. A single module can support fan-out of 8 modules for precise triggering and repeatability. Driver boards may be used to scale any number of modules

Ordering Information

- M9330A** 15-bit, 1.25 GS/s arbitrary waveform generator
- M9331A** 10-bit, 1.25 GS/s arbitrary waveform generator
- N8241A** 15-bit, 1.25 GS/s or 625 MS/s arbitrary waveform generator
- N8242A** 10-bit, 1.25 GS/s or 625 MS/s arbitrary waveform generator

Web Link

www.agilent.com/find/awg

4

Agilent's M9330A and N8241A arbitrary waveform generators deliver unprecedented performance for creation of complex wideband waveforms. High sampling rate and high bit resolution provided in a single instrument enable designers to create ideal waveforms for accurate test of radar, satellite, and frequency agile systems. Each channel of the arbitrary waveform generator provides 500 MHz of modulation bandwidths and over 65 dBc of spurious free dynamic range. When combined with a wideband I/Q upconverter, modulation bandwidth of 1 GHz can be realized at microwave frequencies for authentic signal simulations for IF and RF subsystem test.

Specifications

- Channels: two independent channels available as baseband or IF outputs
 - CH 1: Single-ended and differential
 - CH 2: Single-ended and differential
- Modulation bandwidth: 500 MHz per channel (1 GHz I/Q bandwidth)
- Resolution: 15-bit (1/32,768 levels)
- Output spectral purity – (CH 1 and CH 2)
 - Harmonic distortion: < -65 dBc for each channel DC to 500 MHz
 - Non-harmonic spurious: < -75 dBc for each channel DC to 500 MHz
 - Noise floor: < -150 dBc/Hz across the channel bandwidth
- Sample clock-internal: fixed 1.25 GS/s
- Internal clock output: +3 dBm nominal
- External clock input: tunable 100 MS/s to 1.25 GS/s
- External clock input drive level: +5 to -15 dBm typical
- Phase noise characteristics
 - 1 kHz: -95 dBc/Hz
 - 10 kHz: -115 dBc/Hz
 - 100 kHz: -138 dBc/Hz
 - 1 MHz: -150 dBc/Hz
- Noise floor: -150 dBc/Hz
- Accuracy: same as 10 MHz timebase input

- 4.2 GS/s samples rate
- 12 bit vertical resolution
- 1 or 2 channels, 2 instruments can form a 4 channel instrument
- Differential outputs
- 64 MS waveform memory



81180A

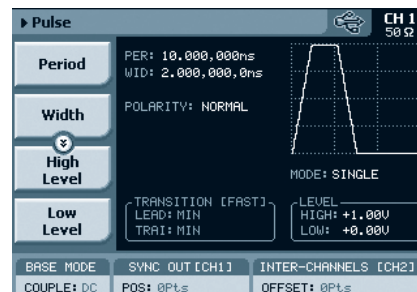
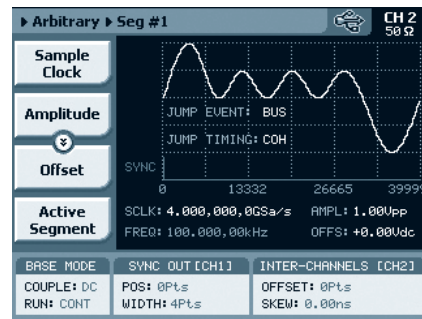

Applications

- Wireless standards with > 1 GHz modulation BW (WiHD, WiGig, Bluetooth 2.0)
- RF environment simulation up to 1.5 GHz (e.g. DVB-T/H, T-DMB)
- UWB up to 2 GHz modulation BW
- Software defined radio
- Satellite
- Radar
- General purpose arbitrary waveform generator and function generator
- Education

Specifications

- 10 MS/s – 4.2 GS/s, 12 bit arbitrary waveform and function generator
- 1 or 2 channel (coupled/uncoupled)
- 2 GHz IQ modulation bandwidth
- Two instrument can be synchronized to form 4 channel system
- Three software selectable amplifier
 - Optimized for I/Q applications in conjunction with Vector PSG with 1 GHz, differential output and DC coupled
 - Optimized for maximum bandwidth and flatness for direct RF applications with up to 1.5 GHz, single-ended and AC coupled
 - Optimized for applications in the time domain with low overshoot and jitter with differential output, DC coupled and 600 ps transition times
- Internal and external clock
- Up to 64 M sample memory
- Two markers per channel with adjustable width and levels
- Advanced sequencing capabilities (step, loop, nested and conditional jumps)
- Trigger input to control sequence advance
- 8-bit dynamic control connector
- Integration in Agilent Waveform Editor, MATLAB, LabView and Signal Studio

Ordering Information

- 81180A** 4.2 GSa/s arbitrary waveform generator
- 81180A-116** 1 channel, 16 M points memory
- 81180A-216** 2 channel, 16 M points memory
- 81180A-264** 2 channel, 64 M points memory
- 81180A-SYN** synchronization cable to build up a 4 channel instrument out of two 81180A
- 81180A-F4G** reconstruction filter set for 4 GSa/s – 1 channel

Web Link

www.agilent.com/find/81180

81101A
 81104A with
 81105A
 81150A
 81110A with
 81111A
 81110A with
 81112A
 81130A with
 81131A
 81130A with
 81132A
 81133A
 81134A
 E8311A
 E8312A

81101A

- 1 channel
- Up to 20 Vpp (into 50 Ohm)
- Variable transition times between 5 ns and 200 ms
- Internal and external clocking
- 1 mHz to 50 MHz repetition rate
- Glitch-free timing changes
- Triggerable or internal PLL
- Single ended outputs

81104A with 81105A

- 1 or 2 channels
- Up to 20 Vpp (into 50 Ohm)
- Variable transition times between 3 ns and 200 ms
- Internal and external clocking
- Glitch-free timing changes
- Triggerable or internal PLL
- Single ended outputs
- Analog channel addition
- Complex data patterns
- Pseudo random binary sequence (PRBS) generation

81150A

- 1 or 2 channels
- 1 µHz – 120 MHz pulses with variable rise/fall time
- 1 µHz – 240 MHz sine waveform outputs
- 2 GSa/s and 14 bit vertical resolution
- Precise digital noise: crest factor (peak/RMS) selectable: 3.1, 4.8, 6.0, 7.0
- Noise repetition 26 days
- Pulse, sine, square, ramp, noise and arbitrary waveforms
- Triggerable
- FM, AM, PM, FSK, PWM modulation capability
- Full control of all pulse parameters (rise/fall/width/etc)
- Differential outputs
- Ideal and arbitrary bit shaped pattern up to 120 Mbit/s
- Three level signals
- PRBS 2³¹
- 16 MBit pattern memory

81110A, 81111A and 81112A

- 1 or 2 channels
- Up to 20 Vpp (into 50 Ohm)
- Variable transition times between 3 ns and 200 ms
- Internal and external clocking
- 1 mHz to 330 MHz repetition rate
- Glitch-free timing changes
- Triggerable or internal PLL
- Single ended outputs
- Analog channel addition
- Data patterns
- Pseudo random binary sequence (PRBS) generation

E8311A and E8312A pulse pattern generators

- Same as 81110A in VXI form factor

81130A with 81131A

- 1 or 2 channels
- Up to 3.8 Vpp (into 50 Ohm)
- Selectable transition times 800 ps or 1.6 ns
- Internal and external clocking
- 1 kHz to 400 MHz repetition rate
- Precision timing
- Differential outputs
- EXOR channel addition
- Complex data pattern and pattern segment looping
- Pseudo random binary sequence (PRBS) generation

81130A with 81132A

- 1 or 2 channels
- Up to 2.5 Vpp (into 50 Ohm)
- Fixed transition times 500 ps typ.
- Internal and external clocking
- 1 kHz to 660 MHz repetition rate
- Precision timing
- Differential outputs
- EXOR channel addition
- Up to 1.32 Gbit/s data generation
- Complex data patterns and pattern segment looping e.g. for USB 2.0 pre-compliance testing
- Pseudo random binary sequence (PRBS) generation

81133A and 81134A

- 1 channel (81133A) or 2 channels (81134A)
- 50 mV up to 2 Vpp amplitude (into 50 Ohm)
- Programmable termination voltage
- Transition times < 90 ps (adjustable between 70 – 120 ps typ.)
- 15 MHz to 3.35 GHz repetition rate
- Total jitter typically less than 2 ps RMS jitter
- 12 Mbit pattern memory per channel
- PC-based pattern management software
- 1.5 ps typ. clock jitter
- Differential outputs
- Complex data patterns e.g. for PCI Express, SATA
- Pseudo random binary sequence (PRBS) generation
- Delay Modulation: –250 to 250 ps (up to 500 ps total jitter)
- Modulation Frequency: 0 – 200 MHz
- Additional variable crossover between 30 – 70% typ.
- NRZ/RZ/R1 signal formats over the full frequency range

Leading Pulse, Pattern, Data and Clock Generation for All Test Needs in Digital Design and Manufacturing

Agilent Technologies offers a comprehensive portfolio of signal generation instruments for digital waveforms and data signal. Whether your applications calls for

- Demanding digital pulses
- High-speed clock signals
- Square waves
- Flexible serial or
- Parallel bit patterns and data streams

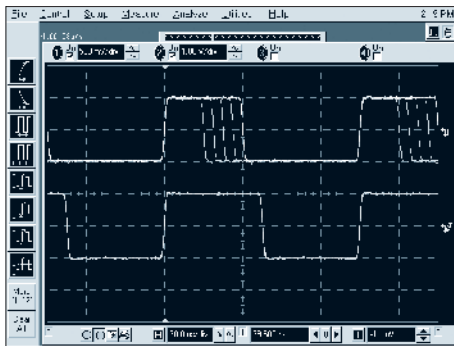
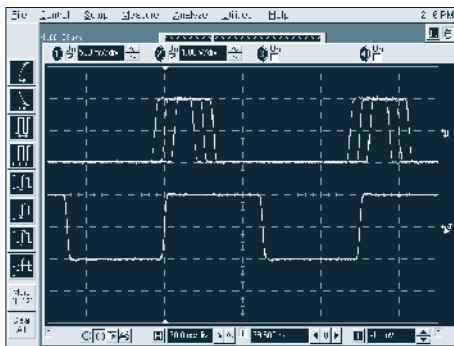

Flexible pulse generation

The Agilent *81101A 50 MHz pulse generator* is the instrument of choice for cost efficient pulse and clock generation providing flexibility and full control over timing parameters.

- 1 channel
- Up to 20 Vpp (into 50 Ohm)
- Variable transition times between 5 ns and 200 ms
- Internal and external clocking
- 1 MHz to 50 MHz repetition rate
- Glitch-free timing changes
- Triggerable or internal PLL
- Single ended outputs



The Agilent *81104A 80 MHz pulse generator* provides the same pulse generation capability as the 81101A with an enhanced frequency range. Even greater flexibility is provided by the modular output channel concept: one or two 81105A output channels can be configured in the 81104A mainframe.

- 1 or 2 channels
- Up to 20 Vpp (into 50 Ohm)
- Variable transition times between 3 ns and 200 ms
- Internal and external clocking
- Glitch-free timing changes
- Triggerable or internal PLL
- Single ended outputs
- Analog channel addition
- Complex data patterns
- Pseudo random binary sequence (PRBS) generation



The Agilent *81150A* is a pulse function arbitrary noise generator. The 4-in-1 instrument is designed for best signal generation whether ideal or real-world signals are needed.

It offers flexible pulse, clock and trigger generation with highest signal quality and with a frequency range up to 120 Mhz. It is therefore a perfect fit for all system clock or trigger applications. In addition to the typical digital applications mixed signal devices and analog devices can be tested to its limits. The reproducible noise combined with the modulation capabilities up to 10 MHz allow repeatable real-world testing.

- 4-in-1 instrument for ideal and real-world signals
- Precise 120 Mhz pulse generator with variable timing parameters
- Digital noise generator to stress your device to its limits
- Function arbitrary generator up to 240 MHz sine waves
- Optional pattern generator for ideal analog, digital and mixed signal devices

- 81101A
- 81104A with
- 81105A
- 81150A
- 81110A with
- 81111A
- 81110A with
- 81112A
- 81130A with
- 81131A
- 81130A with
- 81132A
- 81133A
- 81134A
- E8311A
- E8312A

81101A
81104A with
81105A
81150A
81110A with
81111A
81110A with
81112A
81130A with
81131A
81130A with
81132A
81133A
81134A
E8311A
E8312A

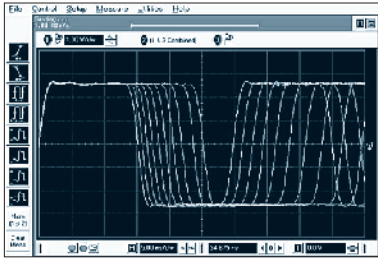

Glitch-free timing changes

The Agilent *81110A 165 MHz pulse pattern generator* with one or two 81111A output channels is the industry-standard for pulse, pattern, data and PRBS generation up to 165.

- 1 or 2 channels
- Up to 20 Vpp (into 50 Ohm)
- Variable transition times between 3 ns and 200 ms
- Internal and external clocking
- 1 MHz to 80 MHz repetition rate
- Glitch-free timing changes
- Triggerable or internal PLL
- Single ended outputs
- Analog channel addition
- Data patterns
- Pseudo random binary sequence (PRBS) generation



The *81130A 400 MHz pulse pattern generator* with one or two 81131 output channels satisfies higher timing and precision demands. On top of the enhanced data generation and pattern segment looping features allow you to generate complex data patterns.

- 1 or 2 channels
- Up to 3.8 Vpp (into 50 Ohm)
- Selectable transition times 800 ps or 1.6 ns
- Internal and external clocking
- 1 kHz to 400 MHz repetition rate
- Precision timing
- Differential outputs
- EXOR channel addition
- Complex data pattern and pattern segment looping
- Pseudo random binary sequence (PRBS) generation

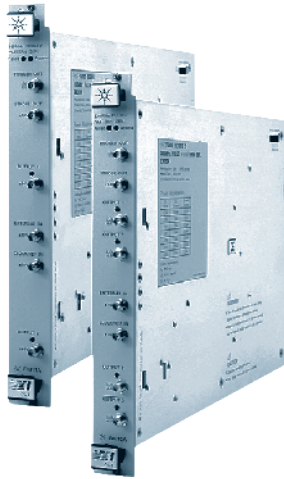

The Agilent *81110A 330 MHz pulse pattern generator* with one or two 81112A output channels provides up to two differential output channels with fast transition times for a broad range of tests.

- 1 or 2 channels
- Up to 3.8 Vpp (into 50 Ohm)
- Selectable transition times 800 ps or 1.6 ns
- Internal and external clocking
- 1 MHz to 330 MHz repetition rate
- Glitch-free timing changes
- Triggerable or internal PLL
- Differential outputs
- Data patterns
- Pseudo random binary sequence (PRBS) generation

From the versatility of Agilent Technologies 81110A comes the convenience of VXI with the *E8311A, E8312A and E8305A pulse pattern generators*. These exercise the same specifications as the 81111A and 81112A modules with the same programmability and pattern and data sequence capabilities in a plug & play VXI form (C-size, 1 slot) – compatibility that makes the transition from lab to production quick and simple.

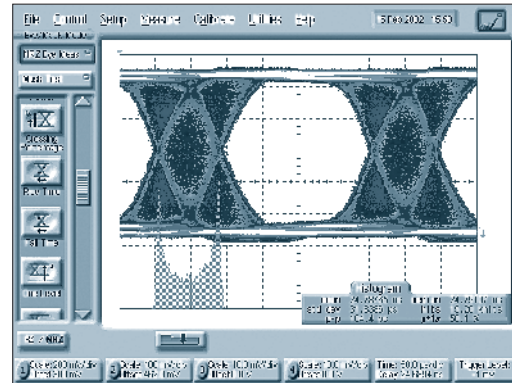

Jitter modulated with sine wave

The Agilent *81130A 660 MHz pulse pattern generator* with one or two 81132A output channels offers up to 1.32 Gbit/s by the digital channel add feature.

- 1 or 2 channels
- Up to 2.5 Vpp (into 50 Ohm)
- Fixed transition times 500 ps typ.
- Internal and external clocking
- 1 kHz to 660 MHz repetition rate
- Precision timing
- Differential outputs
- EXOR channel addition
- Up to 1.32 Gbit/s data generation
- Complex data patterns and pattern segment looping e.g. for USB 2.0 pre-compliance testing
- Pseudo random binary sequence (PRBS) generation

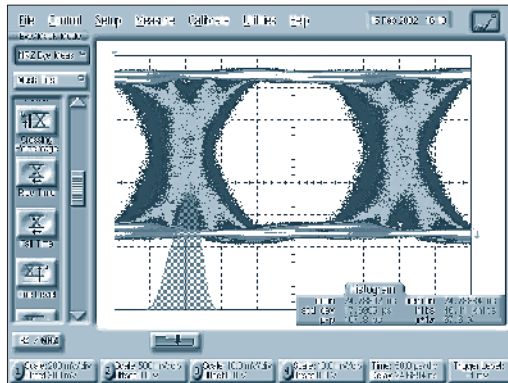

Jitter modulated with noise

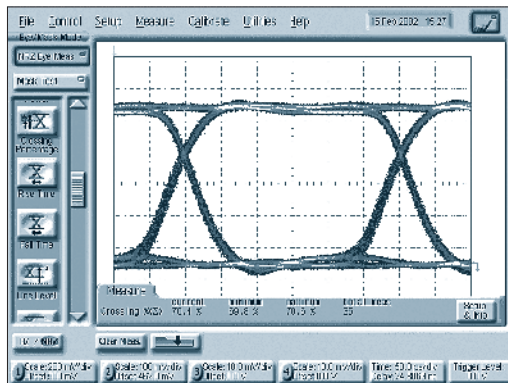

Variable cross over point at 70%

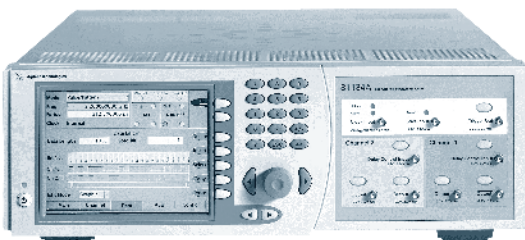

81133/34A pulse pattern generator, 3.35 GHz, dual-channel

Ordering Information

Main products

Mainframe	Output channels and hardware options	Description
81101A		50 MHz pulse generator
81104A	81105A (1 or 2)	80 MHz pulse generator 80 MHz output channel for 81104A
81150A-001		1 channel pulse function arbitrary generator
81150A-002		2 channel pulse function arbitrary generator
81110A	81111A (1 or 2) 81112A (1 or 2)	165/330 MHz pulse pattern generator 165 MHz output channel for 81110A 330 MHz output channel for 81110A
81130A	81131A 81132A	400/660 MHz pulse pattern generator 400 MHz output channel for 81130A 660 MHz output channel for 81130A
81133A		3.35 GHz 1 channel pulse pattern generator
81134A		3.35 GHz 2 channel pulse pattern generator
E8311A	(Included)	165 MHz VXI pulse pattern generator
E8312A	(Included)	330 MHz VXI pulse pattern generator

81101A
81104A with
81105A
81150A
81110A with
81111A
81110A with
81112A
81130A with
81131A
81130A with
81132A
81133A
81134A
E8311A
E8312A

Web Link

www.agilent.com/find/pulse

When timing is crucial and high performance is required, the Agilent 81133A and 81134A provide the fast rise times and low jitter that are required for in depth analyzes and performance characterizations of your devices.

- 1 channel (81133A) or 2 channels (81134A)
- 50 mV up to 2 V_{pp} amplitude (into 50 Ohm)
- Programmable termination voltage
- Transition times < 90 ps (adjustable between 70 – 120 ps typ.)
- 15 MHz to 3.35 GHz repetition rate
- Total jitter typically less than 2 ps
- 12 Mbit pattern memory per channel
- PC-based pattern management software
- 1.5 ps typ. RMS jitter
- Differential outputs
- Complex data patterns e.g. for PCI Express, SATA
- Pseudo random binary sequence (PRBS) generation
- Delay modulation: –250 to 250 ps (up to 500 ps total jitter)
- Modulation frequency: 0 – 200 MHz
- Additional variable crossover between 30 – 70% typ.
- NRZ/RZ/R1 signal formats over the full frequency range

Data Generators and Analyzers for Functional and Parametric Tests

Whether you require powerful pulses for the latest generation of laser diodes, need to characterize a high-speed serial bus device at the physical layer or need to get a detailed insight into your systems' signal integrity.

Agilent Technologies offers a comprehensive portfolio containing

- 1 – 2 channel pulse pattern generator up to 3.35 GHz
- Parallel BERT and data generator up to 28 GB/s

Choose the performance and configuration you need.



J-BERT N4903B

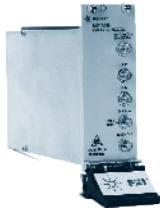

N2102B PXIT pattern generator



81110A pulse pattern generator



81104A pulse pattern generator



81130A pulse data generator



81150A pulse function arbitrary noise generator



81133A, 81134A pulse pattern generator

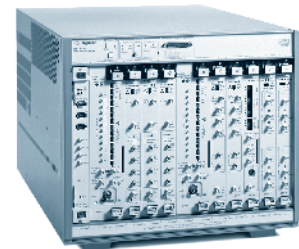
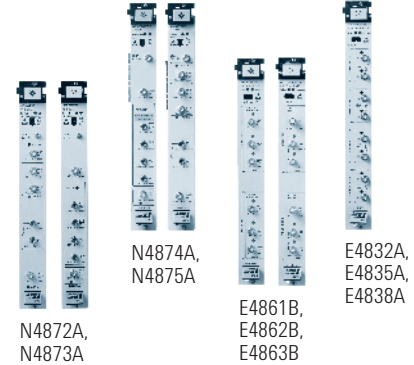

ParBERT 81250

Product	Channels	Frequency range	Data capabilities
81104A pulse pattern generator, 80 MHz	1 or 2, single ended	1 mHz – 80 MHz	16 kBit/channel; PRBS 2 ⁿ⁻¹ , n = 7, 8,...14; RZ, NRZ, DNRZ
81110A pulse pattern generator, 165/330 MHz	1 or 2	1 mHz – 165 MHz with 81111A or 1 mHz – 330 MHz with 81112A	16 kBit/channel; PRBS 2 ⁿ⁻¹ , n = 7, 8,...14; RZ, NRZ, DRNZ
81130A pulse data generator, 400/660 MHz and 1.32 Gb/s	1 or 2	1 kHz – 400 MHz with 81131A or 1 kHz – 660 MHz with 81132A	64 kBit/channel; PRBS 2 ⁿ⁻¹ , n = 7, 8,...15; RZ, NRZ, DNRZ
81150A pulse function arbitrary noise generator	1 or 2	120 Mbits 120 MHz pulse, 240 MHz sine	PRBS –7, 9, 11, 15, 23, and 31 Pattern modulation: AM, FM, PM User defined and predefined bit transitions with up to 64 arbitrary waveform points per bit transitions
81133A pulse pattern generator, 3.35 GHz, single channel	1	15 MHz – 3.35 GHz	12 MBit/channel; PRBS 2 ⁿ⁻¹ , n = 5, 6,...15, 23, 31; RZ, NRZ, DNRZ, R1
81134A pulse pattern generator, 3.35 GHz, dual-channel	2	15 MHz – 3.35 GHz	12 MBit/channel; PRBS 2 ⁿ⁻¹ , n = 5, 6,...15, 23, 31; RZ, NRZ, DNRZ, R1
13.5 Gb/s ParBERT modules (N4872A, N4873A)	up to 15 (30)	620 Mb/s to 13.5 Gb/s	—
7 Gb/s ParBERT modules (N4874A, N4875A)	up to 15 (30)	620 Mb/s to 7 Gb/s	—
3.35 Gb/s ParBERT modules (E4861B, E4862B, E4863B)	up to 32 (64)	20.84 Mb/s to 3.35 Gb/s	—
675 Mb/s ParBERT modules (E4832A, E4835A, E4838A)	up to 64 (128)	333 Kb/s to 675 Mb/s	—
N4903B J-BERT high-performance serial BERT up to 7 Gb/s and 12.5 Gb/s with complete jitter tolerance	1 or 2	150 Mb/s to 7 or 12.5 Gb/s /14.2 G	32 MBit, PRBS 2 ⁿ⁻¹ , n = 7, 10, 11, 15, 23, 31; NRZ, sequencing with 120
N2102B PXIT pattern generator	1	Fixed rates up to 10.3125 Gb/s	PRBS generations 2 ⁿ⁻¹ , (n = 7, 9, 15, 23, 31) User selectable patterns: K28.5, K28.7, PRBS generations 2 ⁿ⁻¹ , (n=7, 9, 15, 23, 31)

Web Link

www.agilent.com/find/data_generators

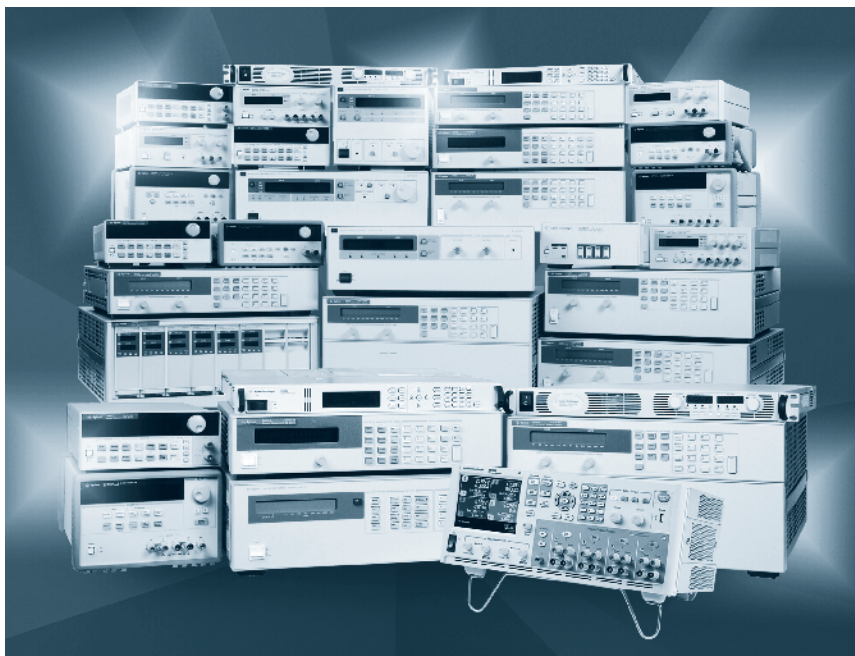

Agilent offers a full line of over 200 power supplies

DC Power Supplies

Since DC power supplies are used in a variety of applications, Agilent offers a wide selection – from 20 W up to 6600 W – in a variety of performance, system, and bench models as well as specialty and modular power systems. In order to protect your device under test, all Agilent DC power supplies offer over voltage protection (OVP). Most Agilent power supplies offer over current protection (OCP) and/or over temperature protection (OTP) in addition to OVP.

Specialty

Agilent offers DC power supplies with critical performance characteristics required for specific applications such as mobile communications and solar array simulation.

Modular

Agilent offers fully programmable power supplies in a modular format such as the N6700 modular power system. There is an extensive choice of power options, from basic through performance. Additionally all the modules interact in the same way at a single interface node which simplifies system architecture and reduces cost when your test system changes.

Performance

Speed, accuracy and advanced programming features make performance power supplies the right choice when the DC power supply is a factor in test performance. With features such as fast programming times and

downloadable V&I sequences, these DC power supplies reduce your risk during test and system development.

Basic

Affordable, quiet and stable power supplies for both manual and simple computer controlled operation, the Agilent line of basic power supplies are ideal for both manual and automatic testing. These power supplies are available in bench-friendly or system-ready models and provide cost effective, essential power sourcing capabilities to meet your testing needs.

Application Specific DC Power Supplies

Model	Max voltage per output (DC)	Max current per output (DC)	Number of outputs	Total max power	Key features/application	Page
N6781A	20 V	±3 A	1	20 W	2-quadrant source measure unit for battery drain analysis	228, 229
N6782A	20 V	±3 A	1	20 W	2-quadrant source measure unit for functional test	
N6784A	±20 V	±3 A	1	20 W	4-quadrant general purpose source measure unit	
66300 family	15 V	5 A	2	45 W	Mobile communications DC power sources – single and dual output high performance supplies function as a power source alternative to batteries and charger for testing mobile phones and portable devices. Front panel and GPIB interfaces	223
66332A	20 V	5 A	1	100 W		
E4360 family	130 V _{oc}	8.5 I _{sc}	2	1200 W	Modular solar array simulator (SAS) – dual output programmable DC power source that simulates the output characteristics of a solar array. Low profile (19 inches wide x 2 U high) ¹ mainframe. Two modules to choose from (E4361A, E4362A). Advanced programming capabilities through LAN (LXI Class C), GPIB, and USB	224, 225
E4356A	80 V	30 A	1	2100 W	Telecommunications DC power source – dual range high performance DC power supply provides maximum power at both 70 and 80 V ranges. Used for telecom hardware that operates from a 48 V or higher rail, such as base stations switches. Advanced programming via GPIB	See web link below

For more information, visit our web site at www.agilent.com/find/E4356

¹ U refers to one rack unit of a standard EIA equipment rack. 1 U high = 1.75 inches (44.4 mm) of vertical rack space

System DC Power Supplies

Modular DC power systems/ analyzer	Max voltage per output (DC)	Max current per output (DC)	Max number of outputs	Total max power	Key features/application	Page
N6700B	100 V	50 A	4	400 W	Low-profile (19 inches wide by 1 U high) ¹ modular power system mainframe with over 20 different N6700 modules to choose from, including: basic, performance, precision, and SMU. Remote programming via LAN (LXI Class C), USB, and GPIB. Used in automated test for supplying bias power and stimulus to sub-assemblies and final products. Synchronize to other events in your ATE system with advanced hardware and software triggering	226, 227
N6701A	100 V	50 A	4	600 W		
N6702A	100 V	50 A	4	1200 W		
N6705B	100 V	50 A	4	600 W	DC power analyzer mainframe, uses any N6700 Series module. Easy to use front panel and fully programmable over LAN (LXI), USB, and GPIB. Used in R&D for power on sequence of prototypes and battery drain applications	226, 227
66000A	200 V	16 A	8	1200 W	Modular power system mainframe (19 inches wide x 4 U high) ¹ with 6 different modules to choose from. Remote programming via GPIB. Used in automated test for supplying bias power and stimulus to sub-assemblies and final products	See web link below

For more information, visit our web site at www.agilent.com/find/66000

Multiple output high performance supplies	Max voltage per output (DC)	Max current per output (DC)	Number of outputs	Total max power	Key features/application
6621A, 6622A	50 V	10 A	2	160 W	Dual output system power supply (19 inches wide x 3 U high) ¹ , low and high ranges, remote programming via GPIB. Two 80 W outputs
6623A	50 V	10 A	3	160 W	Triple output system power supply (19 inches x 3 U high) ¹ , low and high ranges, remote programming via GPIB. Two 40 W and one 80 W outputs
6624A, 6627A	50 V	5 A	4	160 W	Quad output system power supply (19 inches wide x 3 U high) ¹ , low and high ranges, remote programming via GPIB. Four 40 W outputs
6625A, 6628A	50 V	2 A	2	100 W	Precision dual output system power supply (19 inches wide x 3 U high) ¹ , low and high ranges, remote programming via GPIB. One 25 W and one 50 W output (6625A); Two 50 W outputs (6628A)
6626A, 6629A	50 V	2 A	4	200 W	Precision quad output system power supply (19 inches wide x 3 U high) ¹ , low and high ranges, remote programming via GPIB. Two 25 W and two 50 W outputs (6626A); Four 50 W outputs (6629A)

For more information, visit our web site at www.agilent.com/find/6620

Single output high performance supplies	Max voltage (DC)	Max current (DC)	Max power	Key features/application
6611C	8 V	5 A	40 W	High performance single output, system power supply, small compact for R&D bench use (9.5 inches wide x 2 U high) ¹ , front panel control and advance programming features via GPIB and RS232 interfaces
6612C	20 V	2 A	40 W	
6613C	50 V	1 A	50 W	
6614C	100 V	5 A	50 W	

For more information, visit our web site at www.agilent.com/find/6610

6631B	8 V	10 A	80 W	High performance single output, system power supply (19 inches wide x 2 U high) ¹ , front panel control and advance programming features via GPIB and RS232 interfaces
6632B	20 V	5 A	100 W	
6633B	50 V	2 A	100 W	
6634B	100 V	1 A	100 W	

For more information, visit our web site at www.agilent.com/find/6630

6641A, 6541A	8 V	20 A	160 W	High performance single output, system power supply (19 inches wide x 2 U high) ¹ , front panel control, analog control of output voltage and current. Advanced programming features via GPIB and RS232 interfaces (664xA units only)
6642A, 6542A	20 V	10 A	200 W	
6643A, 6543A	35 V	6 A	210 W	
6644A, 6544A	60 V	3.5 A	210 W	
6645A, 6545A	120 V	1.5 A	180 W	

For more information, visit our web site at www.agilent.com/find/6640 or www.agilent.com/find/6540

6651A, 6551A	8 V	50 A	400 W	High performance single output system power supply (19 inches wide x 3 U high) ¹ , front panel control, analog control of output voltage and current. Advanced programming features via GPIB interface (665x units only). Several special options (J0x, J1x) are available with different maximum voltage and current, but power remains approximately 500 W
6652A, 6552A	20 V	25 A	500 W	
6653A, 6553A	35 V	15 A	525 W	
6654A, 6554A	60 V	9 A	540 W	
6655A, 6555A	120 V	4 A	480 W	

For more information, visit our web site at www.agilent.com/find/6650 or www.agilent.com/find/6550

6671A, 6571A	8 V	220 A	1760 W	High performance single output system power supply (19 inches wide x 3 U high) ¹ , front panel control, analog control of output voltage and current. Advanced programming features via GPIB interface (667x units only). Several special options (J0x, J1x) are available with different maximum voltage and current, but power remains approximately 2000 W
6672A, 6572A	20 V	100 A	2000 W	
6673A, 6573A	35 V	60 A	2100 W	
6674A, 6574A	60 V	35 A	2100 W	
6675A, 6575A	120 V	18 A	2160 W	

For more information, visit our web site at www.agilent.com/find/6670 or www.agilent.com/find/6570

¹ U refers to one rack unit of a standard EIA equipment rack. 1 U high = 1.75 inches (44.4 mm) of vertical rack space

Single output high performance (DC) supplies	Max voltage (DC)	Max current (DC)	Max power	Key features/application
6680A	5 V	875 A	4375 W	High performance single output system power supply (19 inches wide x 5 U high) ¹ , front panel control, analog control of output voltage and current. Advanced programming features via GPIB interface
6681A	8 V	580 A	4640 W	
6682A	21 V	240 A	5040 W	
6683A	32 V	160 A	5120 W	
6684A	40 V	128 A	5120 W	

For more information, visit our web site at www.agilent.com/find/6680

6690A	15 V	440 A	6600 W	High performance single output system power supply (19 inches wide x 5 U high) ¹ , front panel control, analog control of output voltage and current. Advanced programming features via GPIB interface
6691A	30 V	220 A	6600 W	
6692A	60 V	110 A	6600 W	

For more information, visit our web site at www.agilent.com/find/6690

Single output, medium performance supplies	Max voltage (DC)	Max current (DC)	Max power	Key features/application	Page
N574xA	100 V	100 A	750 W	Low profile (19 inches wide x 1 U high) ¹ single output DC system power supply. GPIB, LAN (LXI Class C), and USB interfaces	230, 231
N575xA	600 V	5 A	750 W	Low profile (19 inches wide x 1 U high) ¹ single output DC system power supply. GPIB, LAN (LXI Class C), and USB interfaces	230, 231
N576xA	100 V	180 A	1500 W	Low profile (19 inches wide x 1 U high) ¹ single output DC system power supply. GPIB, LAN (LXI Class C), and USB interfaces	230, 231
N577xA	600 V	10 A	1500 W	Low profile (19 inches wide x 1 U high) ¹ single output DC system power supply. GPIB, LAN (LXI Class C), and USB interfaces	230, 231
N873xA	100 V	400 A	3300 W	High power, low profile (19 inches wide x 2 U high) ¹ single output DC system power supply. GPIB, LAN (LXI Class C), and USB interfaces	230, 231
N874xA	600 V	22 A	3300 W	High power, low profile (19 inches wide x 2 U high) ¹ single output DC system power supply. GPIB, LAN (LXI Class C), and USB interfaces	230, 231
N875xA	100 V	250 A	5000 W	High power, low profile (19 inches wide x 2 U high) ¹ single output DC system power supply. GPIB, LAN (LXI Class C), and USB interfaces	230, 231
N876xA	600 V	34 A	5000 W	High power, low profile (19 inches wide x 2 U high) ¹ single output DC system power supply. GPIB, LAN (LXI Class C), and USB interfaces	230, 231

For more information, visit our web site at www.agilent.com/find/N5700 or www.agilent.com/find/N8700

Auto-ranging single output supplies	Max voltage (DC)	Max current (DC)	Max power	Key features/application
6033A	20 V	30 A	242 W	Autoranging single output DC power supply, providing a maximum of power at a variety of operating voltages. Minimizes number of system power supplies. Built in measurements and advanced programming features via GPIB
6038A	60 V	10 A	240 W	
6035A	500 V	5 A	1050 W	
6031A	20 V	120 A	1064 W	
6030A	200 V	17 A	1200 W	
6032A	60 V	50 A	1200 W	

For more information, visit our web site at www.agilent.com/find/6030

¹ U refers to one rack unit of a standard EIA equipment rack. 1 U high = 1.75 inches (44.4 mm) of vertical rack space

Basic Bench DC Power Supplies

Bench	Max voltage per output (DC)	Max current per output (DC)	Number of outputs	Total max power	Key features/application	Page
E3610A – E3612A	120 V	3 A	1	30 W	Single output, dual range DC power supply. Compact size for bench use. Front panel control only	237
E3630A	± 20 V 6 V	.5 A 2.5 A	3	35 W	Triple output DC power supply. Compact size for bench use. Front panel control only	237
E3620A	25 V	1 A	2	50 W	Double output DC power supply. Compact size for bench use. Front panel control only	237
E3614A – E3617A	60 V	6 A	1	60 W	Single output DC power supply. Compact size for bench use. Front panel control only	237
E3640A – E3641A	60 V	3 A	1	30 W	Single output, dual range DC power supply. Compact size for bench and system use. Front panel control, GPIB & RS-232 interfaces for computer programmed control	239
E3642A – E3643A	60 V	5 A	1	50 W		
E3644A – E3645A	60 V	8 A	1	80 W		
E3631A	± 25 V 6 V	1 A 5 A	3	80 W	Triple output DC power supply. Compact size for bench use. Front panel control, GPIB & RS-232 interfaces for computer programmed control	238
E3646A – E3647A	60 V	3 A	2	60 W	Dual output, dual range DC power supply. Compact size for bench and system use. Front panel and GPIB interface	239
E3648A – E3649A	60 V	5 A	2	100 W		
E3632A – E3634A	50 V	20 A	1	200 W	Single output DC power supply. Compact size for bench use. Front panel control, GPIB & RS-232 interfaces for computer programmed control	238

Low cost basic bench supplies	Max voltage per output (DC)	Max current per output (DC)	Number of outputs	Total max power	Key features/application	Page
U3606A	30 V	3 A	1	30 W	Low cost combination power supply and digital multimeter. Single output, dual range DC supply, 5½ digit DMM. Front panel control, GPIB and USB interfaces	134
U8001A	30 V	3 A	1	90 W	Low cost single-output, non-programmable DC power supplies	237
U8002A	30 V	5 A	1	150 W		

Other Power Products

DC loads	Voltage input rating (DC)	Current input rating (DC)	Max number of modules	Input power per module or unit	Key feature/application	Page
N3300A	0 to 240 V	0 to 120 A	6	150 to	DC electronic load mainframe with 6 different modules to choose from. DC loads are used for testing power supplies and other devices requiring a load. Front panel, GPIB, and RS-232 interfaces	232
N3301A	0 to 240 V	0 to 120 A	2	600 W		
6060B	3 to 60 V	0 to 60 A	1	300 W	Single input DC electronic loads, particularly suited for the lab bench. Extensive protection is provided to protect your prototypes under test, including: overvoltage, overcurrent, overtemperature, overpower, and reverse polarity. Front panel and GPIB interfaces	234
6063B	3 to 240 V	0 to 10 A	1	250 W		

AC power supplies	Max voltage output (rms)	Max current output (rms)	Number of phases	Power	Key feature/application	Page
6811B	300 V	3.25 A	1	375 VA	AC power source/analyzer – designed for applications which require precise control, accurate measurement, and analysis of single-phase AC power such as power supply testing, AC Mains (50/60 Hz), CE Mark testing, UPS testing, avionics (400 Hz), testing power factor corrected equipment and telecom equipment. Front panel, GPIB and RS-232 interfaces	235
6812B	300 V	6.5 A	1	750 VA		
6813B	300 V	13 A	1	1750 VA		

Web Link

www.agilent.com/find/power

- Fast transient voltage response
- Precision μA measurement
- Dynamic current pulse measurement
- Exceptional sourcing and current sinking
- GPIB interface, SCPI (standard commands for programmable instruments)

- Programmable output resistance (66319B/D, 66321B/D) for battery emulation
- Simplified test and analysis with 14565B device characterization software

66309B
66309D
66311B
66319B
66319D
66321B
66321D
66332A
14565B

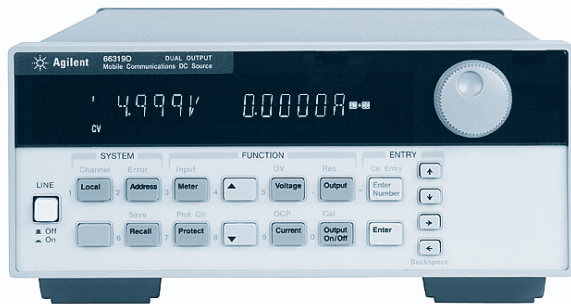

66319 D

Solutions for Battery Powered Devices

Agilent's mobile communications DC sources are a family of 45 watt power supplies that functional as a power-source alternative to batteries and charger for testing mobile phones and portable devices. They offer up to 5 A peak current sourcing, with improved output stability, and superior voltage transient response; Fast Response Power Technology that prevents device shutdowns due to significant voltage drops in the test wiring.

Abbreviated Specifications and Characteristics

Model		66319B 66319D	66321B 66321D	66311B	66309B 66309D	66332A
Number of outputs		2	1	1	2	1
Output ratings – voltage	output 1 output 2	0 to 15 V 0 to 12 V	0 to 15 V —	0 to 15 V —	0 to 15 V 0 to 12 V	0 to 20 V —
Output ratings – current	output 1 output 2	0 to 3 A 0 to 1.5 A	0 to 3 A —	0 to 3 A —	0 to 3 A 0 to 1.5 A	0 to 5 A —
Maximum power per output	output 1 output 2	45 W 18 W	45 W —	45 W —	45 W 18 W	100 W —
Peak current for up to 7 mS Peak current for up to 1 mS	output 1 output 2	5 A 2.5 A	5 A —	5 A —	5 A 2.5 A	5 A —
Programming accuracy – voltage At 25 \pm 5 $^{\circ}\text{C}$	output 1 output 2	0.05% + 10 mV 0.2% + 40 mV	0.05% + 10 mV —	0.05% + 10 mV —	0.05% + 10 mV 0.2% + 40 mV	0.05% + 10 mV —
Programming accuracy – current At 25 \pm 5 $^{\circ}\text{C}$	output 1 output 2	0.05% + 1.33 mA 0.2% + 4.5 mA	0.05% + 1.33 mA —	0.05% + 1.33 mA —	0.05% + 1.33 mA 0.2% + 4.5 mA	0.05% + 2 mA —
Ripple and noise – voltage (rms/p-p) (20 Hz to 20 MHz)	output 1 output 2	1 mV/6 mV ¹ 1 mV/6 mV	1 mV/6 mV ¹ —	1 mV/6 mV ¹ —	1 mV/6 mV ¹ 1 mV/6 mV	.3 mV/3 mV —
Ripple and noise – current (rms) (20 Hz to 20 MHz)	output 1 output 2	2 mA 2 mA	2 mA —	2 mA —	2 mA 2 mA	2 mA —
DC measurement accuracy – voltage	output 1 output 2	0.03% + 5 mV 0.02% + 15 mV	0.03% + 5 mV —	0.03% + 5 mV —	0.03% + 5 mV 0.02% + 15 mV	0.03% + 3 mV —
DC measurement accuracy – current (Applies to output 1 only)	+20 mA to + rated current –20 mA to – rated current –3 to +5 A –1 to +1 A –20 to +20 mA	— — 0.2% + 0.5 mA 0.1% + 0.2 mA 0.1% + 2.5 μA	— — 0.2% + 0.5 mA 0.1% + 0.2 mA 0.1% + 2.5 μA	— — 0.2% + 0.5 mA — 0.1% + 2.5 μA	— — 0.2% + 0.5 mA 0.2% + 1.1 mA 0.1% + 2.5 μA	— — 0.2% + 0.5 mA 0.2% + 1.1 mA 0.1% + 2.5 μA
DC measurement accuracy – current	output 2	0.2% + 3 mA	—	—	0.2% + 3 mA	—
Transient response time	output 1 output 2	< 20 μs^2 < 400 μs^3	< 20 μs^2 —	< 35 μs^2 —	< 35 μs^2 < 400 μs^3	< 100 μs^4 —
Programmable output resistance (Applies to output 1 only)	Range resolution accuracy	–0.04 to 1 Ω 0.001 Ω 0.5% + 2 m Ω	–0.04 to 1 Ω 0.001 Ω 0.5% + 2 m Ω	— — —	— — —	— — —
Voltage input (66309D, 66319D, and 66321D only)	Input range DC readback accuracy Common mode voltage range	\pm 25 V max differential 0.04% + 5 mV –4.5 to 25 V pk	\pm 25 V max differential 0.04% + 5 mV –4.5 to 25 V pk	— — —	\pm 25 V max differential 0.04% + 5 mV –4.5 to 25 V pk	— — —

¹ For phone capacitance higher than 6 μF

² Time for the output voltage to recover to within 20 mV of its final value following a 0.1 to 1.5 A load change in the high mode compensation range

³ Time for the output voltage to recover to within 20 mV of its final value following a 0.75 to 1.5 A load change

⁴ Time for the output voltage to recover to within 20 mV of its final value following any step change in load current up to 2.5 mA

Web Link

www.agilent.com/find/66300
www.agilent.com/find/14565B

E4360A
E4361A
E4362A

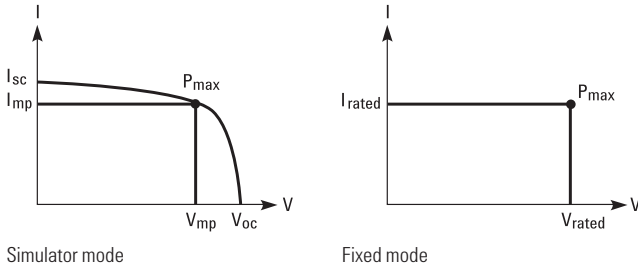

Agilent solar array simulators (SAS) are DC power sources that simulate the output characteristics of a solar array. The SAS is primarily a current source with very low output capacitance and is capable of simulating the I-V curve of different arrays under different conditions. A typical application for a solar array simulator is the simulation of the solar arrays that provide power to satellites. A specialized power supply like an SAS must be used for accurate simulation since the output power of a solar array varies with environmental conditions such as temperature, darkness and light intensity. Agilent solar array simulators provide three operating modes:

Simulator Mode:

An internal algorithm is used to approximate a solar array's I-V curve. Four input parameters are needed to establish a curve in this mode.

- Voc (open circuit voltage)
- Isc (short circuit current)
- Imp (current at the peak power point on the curve)
- Vmp (current and voltage at the peak power point on the curve)

This can be done via the I/O interface or from the front panel when a PC is not needed.

Table Mode:

The I-V curve is determined by a user-defined table of points. A table can have a minimum of 3 points, up to a maximum of 4000 points. A point corresponds to a specific value of I and V. As many as 30 tables may be stored in each of the SAS built-in volatile and non-volatile (E4360A only) memory. The tables (I-V curve) stored in the non-volatile memory (E4360 only) will be retained when the power is turned off, while those stored in volatile memory will be erased after power is removed. In table mode, current and voltage offsets can be applied to the selected table to simulate a change in the operating conditions of the solar array.

Fixed Mode:

This is the default mode the Agilent SAS unit will have when powered on. The SAS unit has the rectangular I-V characteristics of a standard power supply.

E4360 Solar Array Simulator Family Abbreviated Specifications and Characteristics

Model	E4360A mainframe				
		E4361A module	E4362A module	E4362A-J01	E4362A-J02
Number of outputs	per mainframe or unit	up to 2	up to 2	up to 2	up to 2
Maximum power	per output	510 W	600 W	594 W	594 W
Maximum output voltage	open circuit voltage (V_{oc})	65 V	130 V	117 V	120 V
	voltage point (V_{mp})	60 V	120 V	108 V	110 V
	V_{rated}	0 – 60 V	0 – 120 V	0 – 110 V	0 – 120 V
Maximum output current (200 V/230 V/240 V)	short circuit current (I_{sc})	8.5 A	5.0 A	5.5 A	5.4 A
	current point (I_{mp})	8.5 A	5.0 A	5.5 A	5.4 A
	I_{rated}	0 – 8.5 A	0 – 5.0 A	0 – 5.5 A	0 – 5.4 A
Maximum output current (100 V/120 V)	short circuit current (I_{sc})	4.25 A	2.5 A	2.75 A	2.7 A
	current point (I_{mp})	4.25 A	2.5 A	2.75 A	2.7 A
	I_{rated}	0 – 4.25 A	0 – 2.5 A	0 – 2.75 A	0 – 2.7 A
Programming accuracy At $23 \pm 5^\circ\text{C}$	fixed mode voltage	0.075% + 25 mV	0.075% + 50 mV	0.075% + 50 mV	0.075% + 50 mV
	fixed mode current	0.2% + 20 mA	0.2% + 10 mA	0.2% + 11 mA	0.2% + 11 mA
Output voltage ripple and noise (20 Hz to 20 MHz)	simulator/table mode	20 mV _{rms} 125 mV _{p-p}	24 mV _{rms} 195 mV _{p-p}	24 mV _{rms} 195 mV _{p-p}	24 mV _{rms} 195 mV _{p-p}
Readback accuracy (from front panel or over GPIB with respect to actual output @ $23 \pm 5^\circ\text{C}$)	Voltage	0.08% + 25 mV	0.08% + 50 mV	0.08% + 50 mV	0.08% + 50 mV
	+ Current	0.20% + 20 mA	0.20% + 10 mA	0.20% + 11 mA	0.20% + 11 mA
	– Current	0.35% + 48 mA	0.35% + 24 mA	0.35% + 26 mA	0.35% + 26 mA
AC input power		Universal power factor correction			
Size		19 inches wide x 1 U high ¹ , for two outputs			
Hardware trigger		For synchronized curve switching and measurements			
I-V curve switching speed		< 30 ms on up to 100 outputs in fast mode < 250 ms on up to 100 outputs in high resolution			
V & I measurement speed		< 500 ms on up to 100 outputs			
I/O interface		GPIB, LAN, LXI, USB			
Bus speed		1 ms			
List mode		up to 512 curves can be stored			

¹ U refers to one rack unit of a standard EIA equipment rack. 1 U high = 1.75 inches (44.4 mm) of vertical rack space

Web Link

www.agilent.com/find/E4360

- Accurate simulation of any type of solar array
- Up to two outputs of up to 600 W per output in 2U high of rack space
- Fast I-V curve changes to simulate eclipse or spin, using list mode with up to 512 sequenced I-V curves
- Synchronize to other events in your system with advanced hardware and software triggering
- Perform remote programming via GPIB, LAN and USB interfaces with SCPI command set (drivers available)
- Simplify cabling with built-in measurements
- Program I-V curves from the front panel without a need for a controller



E4360A solar array simulator

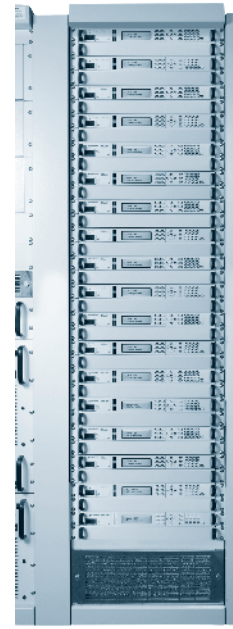

Z2094B solar array simulation system

E4360A
E4361A
E4362A
E4367A
E4368A
Z2094B

Solar Array Trends

As the trend moves toward higher power solar panels, there is a need for a higher-powered solar array simulator or a larger number of solar array simulators to supply the additional power required. Rack space is at a premium. Satellite designers and manufacturers want to quickly and accurately simulate real world conditions placed on a satellite's solar panel in orbit and they want to reduce the size of their test racks by using smaller, higher density solar array simulators.

Next Generation Solar Array Simulator

The Agilent E4360 modular solar array simulator (SAS) is a dual output programmable DC power source that simulates the output characteristics of a solar array. Whether you build your own test system or if you want a full turn-key system with multiple units and integrated software and installation, Agilent gives you the flexibility you need.

Fast I-V Curve Changes

The E4360 offers fast curve changes to enable better simulation of solar arrays under various environmental conditions like eclipse and spin. The resolution of the I-V curve can be set to optimize the curve for resolution or fast curve change. In simulation mode and table mode, you can select high resolution which uses a 4,096 point table to generate a smoother I-V curve within 250 msec. All E4360 SAS in a system can be synchronized to change their I-V curves at the same time using the hardware trigger, such that I-V curves can be changed on up to 100 outputs within 30 or 250 ms depending on resolution setting.

Solar Array Simulation System

The Agilent SAS, solar array system provides precise, fast and cost efficient simulation of multiple segment solar array output characteristics. A typical SAS system contains between 12 and 100 power output modules with each module capable of simulating a single string, segment or solar module. The power output modules can be grouped in collections consistent with the solar array architecture.

The system is based on the Agilent E4360A modular solar array simulators and offers outstanding modularity for dynamic reconfiguration as array architecture changes from program to program. Exceptional MTTR (mean time to repair) including individual module repair and calibration, ensures maximum availability.

Ordering Information

E4360A modular solar array simulator mainframe, 1200 W – holds up to two modules

E4361A solar array simulator DC module 65 V, 8.5 A, 510 W

E4362A solar array simulator DC module 130 V, 5 A, 600 W

E4362A-J01 special option – solar array simulator DC module 117 V, 5.5 A, 594 W

E4362A-J02 special option – solar array simulator DC module 120 V, 5.4 A, 594 W

E4367A pre-configured E4360A SAS mainframe with 2 E4361A modules

E4368A pre-configured E4360A SAS mainframe with 2 E4362A modules

Z2094B-103 solar array simulation (SAS) system

Z2094B-105 SAS system, secondary rack with 18 modules

Z2094B-107 SAS system, 9 modules with booster

Z2094B-113 SAS system, 8 modules with booster

Z2094B-xxx various available custom solar array simulation systems

Web Link

www.agilent.com/find/E4360

N6700B
N6701A
N6702A
N6705B
N6731B to
N6736B
N6741B to
N6746B
N6773A to
N6776A
N6751A to
N6754A
N6761A
N6762A
N6781A
N6782A
N6784A



N6705B DC power analyzer



N6700 modules



N6702A DC modular power system

N6705B DC Power Analyzer

The N6705B DC power analyzer provides unrivaled productivity gains for sourcing and measuring DC voltage and current into the DUT by integrating up to 4 power supply modules with DMM, scope, arbitrary waveform and data logging features.

- Easy to use R&D tool for sourcing and measuring DC voltage and current into the device under test
- Setup and view critical turn-on/turn-off sequences
- Measure and display voltage, current versus time to visualize power into your DUT
- Log data for seconds, minutes, or hours to see current consumption or capture anomalies
- Perform advanced control and analysis with the N6705 DC power analyzer via GPIB, LAN, or USB interfaces with 14585A software
- Access all capabilities without programming
- Choose from more than 20 different DC power modules, including basic, high performance, precision, and source measure units (SMU); ranging up to 300 W per module
- Perform remote programming via GPIB, LAN and USB interfaces with SCPI command set (drivers available)
- LXI Class C compliant

N6700 Low Profile Modular DC Power Supply System

The N6700 Series is a 1 U high programmable DC power supply system with 4 power supply modules and up to 300 W per output – which gives you the flexibility to optimize performance, power and price to match your test needs.

- Designed for ATE systems used in manufacturing and design verification
- Perform rapid voltage changes via fast output programming with active down programming
- Synchronize to other events in your ATE system with advanced hardware and software triggering
- Streamline tasks with built-in measurements, output sequencing and optional LIST mode, built-in digitizer and disconnect relays
- Ultrafast command processing time (< 1 ms) reduces test time
- Choose from more than 20 different DC power modules, including basic, high performance, precision, and source measure units (SMU); ranging up to 300 W per module
- Perform remote programming via GPIB, LAN and USB interfaces with SCPI command set (drivers available)
- LXI Class C compliant

Ordering Information

- N6705B** DC power analyzer, modular, 600 W
- N6700B** low profile modular power system mainframe, 400 W
- N6701A** low profile modular power system mainframe, 600 W
- N6702A** low profile modular power system mainframe, 1200 W
- N673xB** N6700 DC power modules, 50 W
- N674xB** N6700 DC power modules, 100 W
- N677xB** N6700 DC power modules, 300 W
- N675xA** N6700 DC power modules, performance
- N676xA** N6700 DC power modules, precision
- N678xA** N6700 source measure units

N6700 Mainframes

Model	Max number of modules	Total power	Features/applications
N6700B	4	400 W	Low profile (19 inches wide x 1 U high) ¹ , multiple output programmable DC power supply system, used for automated test systems in design verification and manufacturing. Computer control via GPIB, LAN / LXI Class C, and USB
N6701A	4	600 W	
N6702A	4	1200 W	
N6705B	4	600 W	DC power analyzer, used in R&D to characterize prototype power consumption and to generate complex prototype power sequences, new solution for battery drain applications. Front panel and computer control via GPIB, LAN/LXI Class C, and USB

¹ U refers to one rack unit of a standard EIA equipment rack. 1 U high = 1.75 inches (44.4 mm) of vertical rack space

N6700 Single Output Modules

Model	Type	Output ratings			Number of ranges	Programming accuracy		Voltage output ripple and noise (PARD) – 20 Hz to 20 MHz	
		Power	Voltage (DC)	Current (DC)		Voltage	Current	V _{p-p}	V _{rms}
N6731B	Basic	50 W	5 V	10 A	1	0.1% + 19 mV	0.15% + 20 mA	10 mV	2 mV
N6732B	Basic	50 W	8 V	6.25 A	1	0.1% + 19 mV	0.15% + 20 mA	12 mV	2 mV
N6733B	Basic	50 W	20 V	2.5 A	1	0.1% + 20 mV	0.15% + 20 mA	14 mV	3 mV
N6734B	Basic	52.5 W	35 V	1.5 A	1	0.1% + 35 mV	0.15% + 20 mA	15 mV	5 mV
N6735B	Basic	50 W	60 V	0.8 A	1	0.1% + 60 mV	0.15% + 20 mA	25 mV	9 mV
N6736B	Basic	50 W	100 V	0.5 A	1	0.1% + 100 mV	0.15% + 10 mA	30 mV	18 mV
N6741B	Basic	100 W	5 V	20 A	1	0.1% + 19 mV	0.15% + 20 mA	11 mV	2 mV
N6742B	Basic	100 W	8 V	12.5 A	1	0.1% + 19 mV	0.15% + 20 mA	12 mV	2 mV
N6743B	Basic	100 W	20 V	5 A	1	0.1% + 20 mV	0.15% + 20 mA	14 mV	3 mV
N6744B	Basic	105 W	35 V	3 A	1	0.1% + 35 mV	0.15% + 20 mA	15 mV	5 mV
N6745B	Basic	100 W	60 V	1.6 A	1	0.1% + 60 mV	0.15% + 20 mA	25 mV	9 mV
N6746B	Basic	100 W	100 V	1 A	1	0.1% + 100 mV	0.15% + 10 mA	30 mV	18 mV
N6773A	Basic	300 W	20 V	15 A	1	0.1% + 20 mV	0.15% + 60 mA	20 mV	3 mV
N6774A	Basic	300 W	35 V	8.5 A	1	0.1% + 35 mV	0.15% + 60 mA	22 mV	5 mV
N6775A	Basic	300 W	60 V	5 A	1	0.1% + 60 mV	0.15% + 60 mA	35 mV	9 mV
N6776A	Basic	300 W	100 V	3 A	1	0.1% + 100 mV	0.15% + 30 mA	45 mV	18 mV
N6751A	Performance	50 W	50 V	5 A	autoranging	0.06% + 19 mV	0.10% + 20 mA	4.5 mV	350 μV
N6752A	Performance	100 W	50 V	10 A	autoranging	0.06% + 19 mV	0.10% + 20 mA	4.5 mV	350 μV
N6753A	Performance	300 W	20 V	50 A	autoranging	0.06% + 10 mV	0.10% + 30 mA	5 mV	1 mV
N6754A	Performance	300 W	60 V	20 A	autoranging	0.06% + 25 mV	0.10% + 8 mA	6 mV	1 mV
N6761A	Precision	50 W	50 V	1.5 A	1	0.016% + 6 mV	0.5% + 100 nA*	4.5 mV	350 μV
N6762A	Precision	100 W	50 V	3 A	1	0.016% + 6 mV	0.5% + 100 nA*	4.5 mV	350 μV
N6781A	SMU	20 W	20 V	±3 A	3	0.025% + 200 μV	0.03% + 150 μA	12 mV	1.2 mV
N6782A	SMU	20 W	20 V	±3 A	3	0.025% + 200 μV	0.03% + 150 μA	12 mV	1.2 mV
N6784A	SMU	20 W	±20 V	±3 A	3	0.025% + 200 μV	0.025% + 5 μA	12 mV	1.2 mV

* When Option 2UA (200 μA current range) is installed

Web Link

www.agilent.com/find/N6700

N6700B
N6701A
N6702A
N6705B
N6731B to
N6736B
N6741B to
N6746B
N6773A to
N6776A
N6751A to
N6754A
N6761A
N6762A
N6781A
N6782A
N6784A

N6781A
N6782A
N6784A
14585A

- Seamless, dynamic measurements down to nA and μV (N6781A and N6782A only)
- Change sourcing ranges or measurement ranges without any glitches
- Excellent transient response for stable output voltage with dynamic loads
- 2, 4-quadrant operation – use as an advanced power supply or electronic load
- Stable operation with capacitive loads up to 150 μF
- Auxiliary voltage measurement input for battery run down test (N6781A only)
- Programmable output resistance from $-40\text{ m}\Omega$ to $+1\ \Omega$ to simulate internal resistance of a battery (N6781A only)

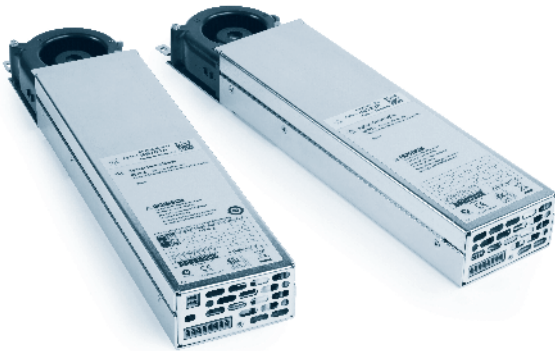

N6780 SMU modules

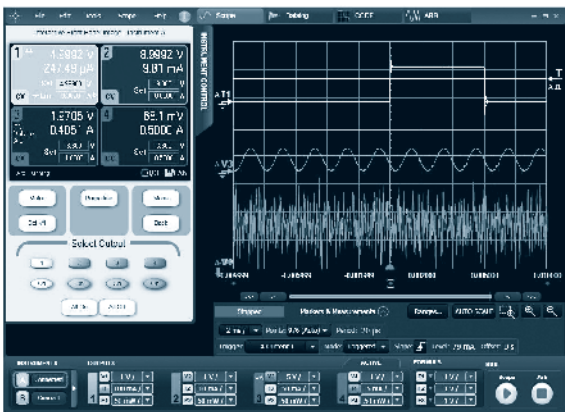

14585 control and analysis software for the DC power analyzer

Seamless Dynamic Measurements

The N6781A and N6782A eliminate the challenges of measuring dynamic currents with a patented feature called seamless measurement ranging. With seamless measurement ranging, you can precisely measure dynamic currents without any glitches or disruptions to the measurement. As the current drawn by the device under test (DUT) changes, the SMU automatically detects the change and switches to the current measurement range that will return the most precise measurement.

When combined with the SMU's built-in 18-bit digitizer, seamless measurement ranging enables unprecedented effective vertical resolution of 28-bits. This provides unrivaled productivity gains and insights into power consumption by enabling engineers to see the complete current waveform they have never seen before, from nano-amps to amps, in one pass and one picture.

N6781A SMU for Battery Drain Analysis

The N6781A 2-quadrant source measure unit for battery drain analysis offers the features required to accurately capture the power consumption of portable, battery-powered devices. When used with the new Agilent 14585A software, the N6781A becomes an even more powerful battery drain analysis solution offering greater measurement insight. The N6781A is ideal for testing devices such as e-Book readers, MP3 players, mobile phones and pacemakers. The N6781A's seamless measurement ranging, programmable output resistance and auxiliary DVM, combine to be the best set of advanced features on the market for battery drain analysis.

N6782A SMU for Functional Test

The N6782A 2-quadrant source measure unit for functional test can modulate its output up to 100 kHz and provides 2-quadrant operation. This makes the SMU a perfect fit for advanced functional test of a variety of devices including DC/DC converters, power management units, and power amplifiers. The input stage of the DUT can be stimulated by the fast sourcing and waveform capabilities. The output stage can be loaded down and measured with the electronic load capabilities of the N6782A. Being able to stimulate the input of a DUT, as well as load down the output, provides a total test solution.

N6784A SMU for General Purpose Test

The N6784A 4-quadrant source measure unit provides precise sourcing and measurement for your general purpose needs. The N6784A offers extended current ranges (100 mA and 10 mA) for more precise sourcing.

N6780 Source Measure Units – Use Modes

The SMU modules can be instantly configured for the most common use cases. When one of the use modes is selected, all of its features and settings are optimized for that particular use case.

- 2-quadrant power supply
- 4-quadrant power supply (N6784A only)
- Unipolar power supply (1 quadrant)
- Constant-Current (CC) electronic load
- Constant-Voltage (CV) electronic load
- Current measure (ammeter mode)
- Battery emulator (N6781A only)
- Battery charger (N6781A only)

14585A Control and Analysis Software for the DC Power Analyzer

The 14585A software complements the front panel of the N6705 DC power analyzer, offering advanced functionality such as statistical analysis tools and PC control. It is a flexible R&D tool for any application that can be utilized to control any of the N6700 family's greater than 20 DC power modules with the N6705.

Key features include:

- Control and analyze data from up to four N6705 DC power analyzer mainframes and any installed modules at once
- Easily create complex waveforms to stimulate or load down a DUT by inputting a formula, choosing from built-in or importing waveform data
- Data log measurements directly to the PC
- Perform statistical analysis of power consumption, including complimentary distribution function.

N6780 SMUs for the N6700 Series Power Systems and Power Analyzer

N6781A
N6782A
N6784A
14585A

Model	N6781A	N6782A	N6784A
DC output ratings:			
Voltage	+20 V	+20 V	±20 V
Current (derated 1% per °C above 40 °C)	±3 A	±3 A	±3 A
Power	20 W	20 W	20 W
Output voltage ripple and noise (PARD): (from 20 Hz – 20 MHz, at full load)			
CV peak-to-peak (20 V range)	12 mV	12 mV	12 mV
CV rms	1.2 mV	1.2 mV	1.2 mV
Load effect (load regulation): (for any load change, based on a load lead drop 1.0 V. The load lead drop reduces the maximum available voltage at the load)			
Voltage	700 µV	700 µV	700 µV
Current	100 µA	100 µA	100 µA
Current (100 mA & 10 mA ranges)	N/A	N/A	1 µA
Source effect (line regulation):			
Voltage	300 µV	300 µV	300 µA
Current	60 µA	60 µA	60 µA
Programming accuracy: (at 23 ± 5 °C after 30 min. warm-up. Applies from minimum to maximum programming range at any load)			
Voltage, 20 V range	0.025% + 1.8 mV	0.025% + 1.8 mV	0.025% + 1.8 mV
Voltage, 6 V range	0.025% + 600 µV	0.025% + 600 µV	0.025% + 600 µV
Voltage, 600 mV range	0.025% + 200 µV	0.025% + 200 µV	0.025% + 200 µV
Current, 3 A & 1 A range	0.04% + 300 µA	0.04% + 300 µA	0.04% + 300 µA
Current, 300 mA range	0.03% + 150 µA	0.03% + 150 µA	0.03% + 150 µA
Current, 100 mA range	N/A	N/A	0.03% + 12 µA
Current, 10 mA range	N/A	N/A	0.025% + 5 µA
Resistance (in 20 V programming range)	0.1% + 1.5 mΩ	N/A	N/A
Resistance (in 6 V programming range)	0.1% + 3 mΩ	N/A	N/A
Measurement accuracy: (at 23 ± 5 °C)			
Voltage, 20 V range	0.025% + 1.2 mV	0.025% + 1.2 mV	0.025% + 1.2 mV
Voltage, 1 V range	0.025% + 75 µV	0.025% + 75 µV	0.025% + 75 µV
Voltage, 100 mV range	0.025% + 50 µV	0.025% + 50 µV	0.025% + 50 µV
Current, 3 A range	0.03% + 250 µA	0.03% + 250 µA	0.03% + 250 µA
Current, 100 mA range	0.025% + 10 µA	0.025% + 10 µA	0.025% + 10 µA
Current, 1 mA range	0.025% + 100 nA	0.025% + 100 nA	0.025% + 100 nA
Current, 10 µA range	0.025% + 8 nA	0.025% + 8 nA	0.025% + 8 nA

Unless otherwise noted, specifications are warranted over the ambient temperature range of 0 to 55 °C after a 30 minute warm-up period. Unless otherwise noted, specifications apply at the mainframe output terminals, with each modules sense terminals internally connected to its output terminals (local sensing)

Ordering Information

N6781A 2-quadrant source measure unit for battery drain analysis

N6782A 2-quadrant source measure unit for functional test

N6784A 4-quadrant general purpose source measure unit

N6705B-056 software license to control N6705A/B with 14585A control and analysis software (option to the N6705B when ordering new)

N6705U-056 upgrade an N6705A/B DC power analyzer with software license

Web Link

www.agilent.com/find/N6780

www.agilent.com/find/14585

N5741A to
N5752A
N5761A to
N5772A
N8731A to
N8742A
N8754A to
N8762A

- 45 models: 750 W and 1.5 kW (N5700); 3.3 kW and 5 kW (N8700)
- 6 to 600 V and 1.3 to 400 A
- Small density 1 U high package (N5700) and 2 U high package (N8700)
- Simplify cabling with built in voltage and current measurements
- Output flexibility with parallel and series connections of multiple supplies, achieving greater output current or voltage
- Perform remote programming via GPIB, LAN, and USB interfaces, with SCPI command set (drivers available)
- LXI Class C compliant



N5700 (1 U high) and N8700 (2 U high) power supplies

Affordable Basic System DC Power Supplies

The Agilent Technologies N5700 and N8700 Series system DC power supplies give you solid performance at an affordable price. These two families provide 750 W, 1500 W, 3300 W, and 5000 W single output programmable supplies, 45 different models for simple DC power applications.

These supplies provide stable output power, built-in voltage and current measurement, and output voltages and current from 6 to 600 V and 1.3 to 400 A. These economical supplies offer many system ready features like multiple standard I/O interfaces to simplify and accelerate test system development for R&D, design validation, and manufacturing engineers in the aerospace/defense, automotive, component and communications industries.

Small, High-Density Package Saves you Space

The N5700 Series provides up to 1500 W in a small space saving 1 U high, 19 inch wide package. The N8700 Series provides up to 5000 W in a small 2 U high, 19 inch wide package. The air vents for both series are in the front and rear (not on the top or bottom), so you can stack other instruments directly above or below it to save valuable rack space.

Extensive Device Protection

To safeguard your device from damage, the N5700 and N8700 Series power supplies provide over-temperature, over-current, and over-voltage protection (OVP) to shut down the power supply output when a fault condition occurs. They also offer an under voltage limit (UVL) that prevents adjustment of the output voltage below a certain limit. The combination of UVL and OVP capabilities lets you create a protection window for sensitive circuitry.

Easy Front-Panel Operation

You can quickly and easily operate the power supply with its rotary knobs and buttons. Using the front-panel controls, you can make course or fine adjustments of output voltage or current, protection settings, and set power-on states. The output voltage and current are displayed simultaneously, and LED indicators show power supply status and operating modes. You can lock the front panel controls to protect against accidental power-supply parameter changes.

Simplify System Connections

The N5700 and N8700 Series power supplies come standard with GPIB, Ethernet/LAN, and USB 2.0 interfaces giving you the flexibility to use your I/O interface of choice today and safeguard your test setup for the future. Both the N5700 Series and the N8700 Series are fully compliant with the LXI Class C specification.

Ordering Information

- N5741A DC system power supply, 6 V, 100 A, 600 W
- N5742A DC system power supply, 8 V, 90 A, 720 W
- N5743A DC system power supply, 12.5 V, 60 A, 750 W
- N5744A DC system power supply, 20 V, 38 A, 760 W
- N5745A DC system power supply, 30 V, 25 A, 750 W
- N5746A DC system power supply, 40 V, 19 A, 760 W
- N5747A DC system power supply, 60 V, 12.5 A, 750 W
- N5748A DC system power supply, 80 V, 9.5 A, 760 W
- N5749A DC system power supply, 100 V, 7.5 A, 750 W
- N5750A DC system power supply, 150 V, 5 A, 750 W
- N5751A DC system power supply, 300 V, 2.5 A, 750 W
- N5752A DC system power supply, 600 V, 1.3 A, 780 W
- N5761A DC system power supply, 6 V, 180 A, 1080 W
- N5762A DC system power supply, 8 V, 165 A, 1320 W
- N5763A DC system power supply, 12.5 V, 120 A, 1500 W
- N5764A DC system power supply, 20 V, 76 A, 1520 W
- N5765A DC system power supply, 30 V, 50 A, 1500 W
- N5766A DC system power supply, 40 V, 38 A, 1520 W
- N5767A DC system power supply, 60 V, 25 A, 1500 W
- N5768A DC system power supply, 80 V, 19 A, 1520 W
- N5769A DC system power supply, 100 V, 15 A, 1500 W
- N5770A DC system power supply, 150 V, 10 A, 1500 W
- N5771A DC system power supply, 300 V, 5 A, 1500 W
- N5772A DC system power supply, 600 V, 2.6 A, 1560 W
- N8731A DC system power supply, 8 V, 400 A, 3200 W
- N8732A DC system power supply, 10 V, 330 A, 3300 W
- N8733A DC system power supply, 15 V, 220 A, 3300 W
- N8734A DC system power supply, 20 V, 165 A, 3300 W
- N8735A DC system power supply, 30 V, 110 A, 3300 W
- N8736A DC system power supply, 40 V, 85 A, 3400 W
- N8737A DC system power supply, 60 V, 55 A, 3300 W
- N8738A DC system power supply, 80 V, 42 A, 3360 W
- N8739A DC system power supply, 100 V, 33 A, 3300 W
- N8740A DC system power supply, 150 V, 22 A, 3300 W
- N8741A DC system power supply, 300 V, 11 A, 3300 W
- N8742A DC system power supply, 600 V, 5.5 A, 3300 W
- N8754A DC system power supply, 20 V, 250 A, 5000 W
- N8755A DC system power supply, 30 V, 170 A, 5100 W
- N8756A DC system power supply, 40 V, 125 A, 5000 W
- N8757A DC system power supply, 60 V, 85 A, 5100 W
- N8758A DC system power supply, 80 V, 65 A, 5200 W
- N8759A DC system power supply, 100 V, 50 A, 5000 W
- N8760A DC system power supply, 150 V, 34 A, 5100 W
- N8761A DC system power supply, 300 V, 17 A, 5100 W
- N8762A DC system power supply, 600 V, 8.5 A, 5100 W
- N5740A rack-mount slide kit

Specifications

Model	Output ratings			Programming accuracy		Voltage output ripple & noise	
	Power	Voltage (DC)	Current (DC)	Voltage	Current	CV V_{p-p}^1	CV V_{rms}^2
N5741A	600 W	6 V	100 A	0.05% + 3 mV	0.1% + 100 mA	60 mV	8 mV
N5742A	720 W	8 V	90 A	0.05% + 4 mV	0.1% + 90 mA	60 mV	8 mV
N5743A	750 W	12.5 V	60 A	0.05% + 6.25 mV	0.1% + 60 mA	60 mV	8 mV
N5744A	760 W	20 V	38 A	0.05% + 10 mV	0.1% + 38 mA	60 mV	8 mV
N5745A	750 W	30 V	25 A	0.05% + 15 mV	0.1% + 25 mA	60 mV	8 mV
N5746A	760 W	40 V	19 A	0.05% + 20 mV	0.1% + 19 mA	60 mV	8 mV
N5747A	750 W	60 V	12.5 A	0.05% + 30 mV	0.1% + 12.5 mA	60 mV	8 mV
N5748A	760 W	80 V	9.5 A	0.05% + 40 mV	0.1% + 9.5 mA	80 mV	8 mV
N5749A	750 W	100 V	7.5 A	0.05% + 50 mV	0.1% + 7.5 mA	80 mV	8 mV
N5750A	750 W	150 V	5 A	0.05% + 75 mV	0.1% + 5 mA	100 mV	12 mV
N5751A	750 W	300 V	2.5 A	0.05% + 150 mV	0.1% + 2.5 mA	150 mV	20 mV
N5752A	780 W	600 V	1.3 A	0.05% + 300 mV	0.1% + 1.3 mA	300 mV	60 mV
N5761A	1080 W	6 V	180 A	0.05% + 3 mV	0.1% + 180 mA	60 mV	8 mV
N5762A	1320 W	8 V	165 A	0.05% + 4 mV	0.1% + 165 mA	60 mV	8 mV
N5763A	1500 W	12.5 V	120 A	0.05% + 6.25 mV	0.1% + 120 mA	60 mV	8 mV
N5764A	1520 W	20 V	76 A	0.05% + 10 mV	0.1% + 76 mA	60 mV	8 mV
N5765A	1500 W	30 V	50 A	0.05% + 15 mV	0.1% + 50 mA	60 mV	8 mV
N5766A	1520 W	40 V	38 A	0.05% + 20 mV	0.1% + 38 mA	60 mV	8 mV
N5767A	1500 W	60 V	25 A	0.05% + 30 mV	0.1% + 25 mA	60 mV	8 mV
N5768A	1520 W	80 V	19 A	0.05% + 40 mV	0.1% + 19 mA	80 mV	8 mV
N5769A	1500 W	100 V	15 A	0.05% + 50 mV	0.1% + 15 mA	80 mV	8 mV
N5770A	1500 W	150 V	10 A	0.05% + 75 mV	0.1% + 10 mA	100 mV	12 mV
N5771A	1500 W	300 V	5 A	0.05% + 150 mV	0.1% + 5 mA	150 mV	20 mV
N5772A	1560 W	600 V	2.6 A	0.05% + 300 mV	0.1% + 2.6 mA	300 mV	60 mV
N8731A	3200 W	8 V	400 A	0.05% + 4 mV	0.1% + 800 mA	60 mV	8 mV
N8732A	3300 W	10 V	330 A	0.05% + 5 mV	0.1% + 660 mA	60 mV	8 mV
N8733A	3300 W	15 V	220 A	0.05% + 7.5 mV	0.1% + 440 mA	60 mV	8 mV
N8734A	3300 W	20 V	165 A	0.05% + 10 mV	0.1% + 330 mA	60 mV	8 mV
N8735A	3300 W	30 V	110 A	0.05% + 15 mV	0.1% + 220 mA	60 mV	8 mV
N8736A	3400 W	40 V	85 A	0.05% + 20 mV	0.1% + 170 mA	60 mV	8 mV
N8737A	3300 W	60 V	55 A	0.05% + 30 mV	0.1% + 110 mA	60 mV	8 mV
N8738A	3360 W	80 V	42 A	0.05% + 40 mV	0.1% + 84 mA	80 mV	25 mV
N8739A	3300 W	100 V	33 A	0.05% + 50 mV	0.1% + 66 mA	100 mV	25 mV
N8740A	3300 W	150 V	22 A	0.05% + 75 mV	0.1% + 44 mA	100 mV	25 mV
N8741A	3300 W	300 V	11 A	0.05% + 150 mV	0.1% + 22 mA	300 mV	100 mV
N8742A	3300 W	600 V	5.5 A	0.05% + 300 mV	0.1% + 11 mA	500 mV	120 mV
N8754A	5000 W	20 V	250 A	0.025% + 15 mV	0.1% + 750 mA	75 mV	10 mV
N8755A	5100 W	30 V	170 A	0.025% + 22.5 mV	0.1% + 510 mA	75 mV	10 mV
N8756A	5000 W	40 V	125 A	0.025% + 30 mV	0.1% + 375 mA	75 mV	10 mV
N8757A	5100 W	60 V	85 A	0.025% + 45 mV	0.1% + 255 mA	75 mV	10 mV
N8758A	5200 W	80 V	65 A	0.025% + 60 mV	0.1% + 195 mA	100 mV	15 mV
N8759A	5000 W	100 V	50 A	0.025% + 75 mV	0.1% + 150 mA	100 mV	15 mV
N8760A	5100 W	150 V	34 A	0.025% + 112.5 mV	0.1% + 102 mA	120 mV	25 mV
N8761A	5100 W	300 V	17 A	0.025% + 225 mV	0.1% + 51 mA	300 mV	60 mV
N8762A	5100 W	600 V	8.5 A	0.025% + 450 mV	0.1% + 25.5 mA	500 mV	120 mV

¹ Up to 20 MHz

² From 5 Hz to 1 MHz

N5741A to
N5752A
N5761A to
N5772A
N8731A to
N8742A
N8754A to
N8762A

Web Link

www.agilent.com/find/N5700

www.agilent.com/find/N8700

N3300A to
N3307A

- Accurate programmable control in CC, CV, and CR modes
- Download lists of commands for fast execution
- Continuous and pulse loading
- Synchronize loading and measurement of all inputs
- Analog programming for waveform generation
- DC connection terminal for ATE applications



N3300A

- Simultaneous measurement of voltage, current, and power
- Synchronize loading and measurements of all inputs
- Waveform digitization
- Parallel units for higher power
- Increase test system throughput

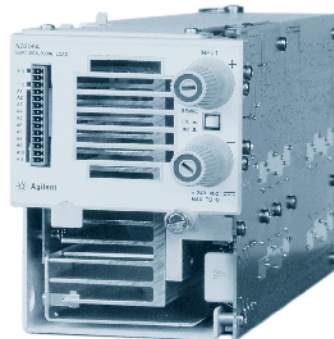

N3306A

Optimized for High-Volume Manufacturing Test

These loads provide many tools to significantly reduce test time of DC power supplies in high-volume manufacturing environments. They execute all commands quickly, and have many features to assist in increasing system throughput. They also have excellent programming and measurement accuracy.

Flexible Programmable Features

GPIB, RS-232, and analog programming are all standard features. These electronic loads are compatible with the industry standard SCPI command set. Most features are also controllable from the front panel to quickly set up engineering tests on the lab bench. Measurement data can be monitored on the LED front panel display or read by a computer for further processing.

Download Program Sequences

A new feature called lists allows you to download sequences of load input settings to the electronic load. They are then resident in memory and will execute at maximum rate during runtime. This feature will provide reductions in test time for repetitively executed routines in manufacturing test. Up to four 50-step lists can be stored in non-volatile memory for each load input.

Powerful Built-In Measurement Features

The input voltage, current, and power of all load inputs can be accurately and simultaneously measured. Up to 4096 samples can be taken and averaged to provide a high level of accuracy and noise immunity. The 4096 long measurement buffer can be used as a digitizer with programmable sample rate. The measurement can be read by a computer as either one averaged number or a 4096 long array. This capability is available for both current and voltage measurements. It is also possible to store multiple measurements in the buffers to be read back to the computer at the completion of a test.

Mainframe Configuration

The N3300A is a full rack 19 inch width mainframe. It has six slots. The N3301A is a half rack 9.5 inch width mainframe and it has two slots. The 150-, 250- and 300-watt load modules each require one slot. The 500- and 600-watt load modules each require two slots.

Everything You Need in a One-Box Solution

Agilent electronic loads form an integrated solution, which formerly required more instruments and more complex system configuration.

To monitor the outputs of the power supply under test, a DMM would have had to be switched to each power supply output using a multiplexer. Now, the DMM, the multiplexer, the cabling, and current shunts can all be replaced by the accurate measurement system inside each input of the N3300A Series loads. The built-in digitizer within each load module can also replace an oscilloscope, and associated multiplexer and cabling, for many measurement tasks. The result is a simpler, more reliable, and easier to service test system.

DC Load Applications

Constant current

- Power supply load regulation testing
- Battery capacity testing
- Capacitor discharging

Constant voltage

- Current source testing
- Current limit testing
- Shunt regulator

Constant resistance

- Characterizing power supply crossover
- Power supply start-up delay
- Power resistor emulation

Pulse and dynamic loading

- Power supply load transient response
- Power component testing
- Pulse electroplating

Programmable slew rate

- Power supply testing
- Power component testing
- Power supply load transient response
- Program rising and falling rate separately
- Battery capacity testing
- "Real life" load simulation

Specifications

Model	N3302A	N3303A	N3304A	N3305A	N3306A	N3307A
Amperes	0 to 30 A	0 to 10 A	0 to 60 A	0 to 60 A	0 to 120 A	0 to 30 A
Volts	0 to 60 V	0 to 240 V	0 to 60 V	0 to 150 V	0 to 60 V	0 to 150 V
Max. Power @ 40 °C¹	150 W	250 W	300 W	500 W	600 W	250 W
Current at low voltage						
2.0 V	30 A	10 A	60 A	60 A	120 A	30 A
1.5 V	22.5 A	7.5 A	45 A	45 A	90 A	22.5 A
1.0 V	15 A	5 A	30 A	30 A	60 A	15 A
0.5 V	7.5 A	2.5 A	15 A	15 A	30 A	7.5 A
0 V	0 A	0 A	0 A	0 A	0 A	0 A
Constant current mode²						
Low range/high range	3 A/30 A	1 A/10 A	6 A/60 A	6 A/60 A	12 A/120 A	3 A/30 A
Low range accuracy	0.1% + 5 mA	4 mA	7.5 mA	7.5 mA	15 mA	7.5 mA
High range accuracy	0.1% + 10 mA	7.5 mA	15 mA	15 mA	37.5 mA	15 mA
Regulation	10 mA	8 mA	10 mA	10 mA	10 mA	10 mA
Constant voltage mode²						
Low range/high range	6 V/60 V	24 V/240 V	6 V/60 V	15 V/150 V	6 V/60 V	15 V/150 V
Low range accuracy	0.1% + 3 mV	10 mV	3 mV	10 mV	3 mV	10 mV
High range accuracy	0.1% + 8 mV	40 mV	8 mV	20 mV	8 mV	20 mV
Regulation	5 mV	10 mV	10 mV	10 mV	20 mV	10 mV
Constant resistance mode^{2,3}						
Range 1	0.067 to 4 Ω	0.2 to 48 Ω	0.033 to 2 Ω	0.033 to 5 Ω	0.017 to 1 Ω	0.067 to 10 Ω
Range 2	3.6 to 40 Ω	44 to 480 Ω	1.8 to 20 Ω	4.5 to 50 Ω	0.9 to 10 Ω	9 to 100 Ω
Range 3	36 to 400 Ω	440 to 4800 Ω	18 to 200 Ω	45 to 500 Ω	9 to 100 Ω	90 to 1000 Ω
Range 4	360 to 2000 Ω	4400 to 12000 Ω	180 to 2000 Ω	450 to 2500 Ω	90 to 1000 Ω	900 to 2500 Ω
Transient generator						
Frequency range	0.25 Hz to 10 kHz	0.25 Hz to 10 kHz	0.25 Hz to 10 kHz	0.25 Hz to 10 kHz	0.25 Hz to 10 kHz	0.25 Hz to 10 kHz
Pulse width	50 μs ± 1% to 4 seconds ± 1%	50 μs ± 1% to 4 seconds ± 1%	50 μs ± 1% to 4 seconds ± 1%	50 μs ± 1% to 4 seconds ± 1%	50 μs ± 1% to 4 seconds ± 1%	50 μs ± 1% to 4 seconds ± 1%
Current measurement^{4,5}						
Low range	0.05% + 3 mA	2.5 mA	5 mA	5 mA	10 mA	3 mA
High range	0.05% + 6 mA	5 mA	10 mA	10 mA	20 mA	6 mA
Voltage measurement⁶						
Low range	0.05% + 3 mV	10 mV	3 mV	8 mV	3 mV	8 mV
High range	0.05% + 8 mV	20 mV	8 mV	16 mV	8 mV	16 mV
Power measurement⁵						
Accuracy	0.1% + 0.4 W	1.2 W	0.6 W	1.6 W	1.3 W	0.9 W
Programming resolution						
Constant current mode	0.05 mA/0.5 mA	0.02 mA/0.2 mA	0.1 mA/1 mA	0.1 mA/1 mA	0.2 mA/2 mA	0.05 mA/0.5 mA
Constant voltage mode	0.1 mV/1 mV	0.4 mV/4 mV	0.1 mV/1 mV	0.25 mV/2.5 mV	0.1 mV/1 mV	0.25 mV/2.5 mV
Constant resistance mode	0.07/0.7/7/70 mΩ	0.82/8.2/82 mΩ	0.035/0.35/ 3.5/35 mΩ	0.085/0.85/8.5/ 85 mΩ	0.0175/0.175/ 1.75/17.5 mΩ	0.17/1.7/17/170 mΩ
Readback resolution						
Current	0.05 mA/0.5 mA	0.02 mA/0.2 mA	0.1 mA/1 mA	0.1 mA/1 mA	0.2 mA/2 mA	0.05 mA/0.5 mA
Voltage	0.1 mV/1 mV	0.4 mV/4 mV	0.1 mV/1 mV	0.25 mV/2.5 mV	0.1 mV/1 mV	0.25 mV/2.5 mV

Note: Specifications subject to change

* Special modifications are available to change input voltage, current, and accuracy specifications. Please ask us about what is possible

¹ Operating temperature range is 0 to 55 °C. All specifications apply for 25 ± 5 °C unless otherwise noted

² Maximum continuous power available is derated linearly from 100% of maximum at 40 °C, to 75% of maximum at 55 °C

³ Accuracy specification is ±(% of programmed value + fixed offset) in those cases where a percentage + fixed term are given. Otherwise, the specification is given as a negative and positive percentage error term. This specification may degrade when the unit is subject to an RF field of 3 V/meter, the unit is subject to line spikes of 500 V, or an 8 kV electrostatic discharge

⁴ For resistance ranges 3 through 4, accuracy specifications apply with input voltages ≥ 6 V

⁵ DC current accuracy specifications apply 30 seconds after input current is applied

⁶ Accuracy specification is ±(% of reading + fixed offset). Measurement is 1000 samples. This specification may degrade when the unit is subject to an RF field of 3 V/meter, the unit is subject to line spikes of 500 V, or an 8 kV electrostatic discharge

Ordering Information

N3300A 1800 W DC electronic load mainframe

N3301A 600 W half rack width DC electronic load mainframe

N3302A 150 W DC electronic load module

N3303A 250 W DC electronic load module

N3304A 300 W DC electronic load module

N3305A 500 W DC electronic load module

N3306A 600 W DC electronic load module

N3307A 250 W DC electronic load module

Web Link

www.agilent.com/find/N3300

6060B
6063B

- Convenient for lab bench use
- Built-in GPIB programming and measurement
- Continuous and pulse loading operation
- CC, CV, and CR operation
- Trigger for external synchronization



6060B

Single Input DC Electronic Loads

The 6060B and 6063B DC electronic loads are suitable for applications where only one input is needed. They are particularly convenient for engineering lab bench use. They have built-in measurement features, so a DMM is not necessary to monitor the output voltage, current or power of the power supply under test.

Abbreviated Technical Specifications

Model	6060B	6063B
Amperes	0 to 60 A	0 to 10 A
Volts	3 to 60 V	3 to 240 V
Maximum power (at 40 °C)	300 W	250 W
Constant current mode		
Ranges	0 to 6 A, 0 to 60 A	0 to 1 A, 0 to 10 A
Accuracy	0.1% ± 75 mA	0.15% ± 10 mA
Regulation point	10 mA	8 mA
Constant voltage mode		
Accuracy	0.1% ± 50 mV	0.12% ± 120 mV
Regulation (w/remote sense)	10 mV	10 mV
Constant resistance mode		
Ranges	0.033 to 1.0 Ω	0.20 to 24.0 Ω
	1 to 1,000 Ω	24 to 10,000 Ω
	10 to 10,000 Ω	240 to 50,000 Ω
Readback measurement		
Current accuracy	0.05% ± 65 mA	0.12% ± 10 mA
Voltage accuracy	0.05% ± 45 mV	0.1% ± 150 mV

Easy to Use Bench Operation

Entering commands manually using the front panel keypad is simpler because the channel does not need to be specified, as in a mainframe configuration.

Extensive Protection

Extensive protection is included to help protect your valuable prototypes under test. This includes overvoltage, overcurrent, overtemperature, overpower, and reverse polarity.

Manufacturing Test

These loads are also suitable for manufacturing test systems where maximizing speed is not critical. They use industry standard SCPI instructions and have a GPIB interface. For the greatest speed and accuracy in programming and measurement, use the N3300A Series of DC electronic loads.

Ordering Information

- 6060B** single-input, 300 W DC electronic load
- 6063B** single-input, 250 W DC electronic load
- 6063B-020** front panel inputs
- 606xB-908** rackmount kit (p/n 5062-3974)
- 606xB-909** rackmount kit with handles (p/n 5062-3975)

Web Link

www.agilent.com/find/6060

- Versatile AC power test solutions
- Generate stable or distorted AC and DC power
- 50/60 Hz power up to 300 V_{rms}
- 400 Hz avionics power up to 300 V_{rms}
- Arbitrary waveform generation
- Built-in precision power analyzer
- Standard GPIB and RS-232 interfaces (SCPI commands)
- Full protection features (OV, OI, OP, OT)



6811B, 6812B, 6813B

6800 AC Power Solutions AC Power Sources/Analyzers

- 6811B** 300 V_{rms}, 375 VA Single phase model
- 6812B** 300 V_{rms}, 750 VA Single phase model
- 6813B** 300 V_{rms}, 1750 VA Single phase model

Agilent Technologies AC power source/analyzers are designed for applications which require precise control, accurate measurement, and analysis of single-phase AC power. These products are ideal for applications such as power supply testing, AC mains CE mark testing UPS testing, avionics, air traffic control equipment, testing power-factor-corrected equipment and telecom equipment.

Specification¹ (at 0 to 40 °C unless otherwise noted)

		6811B	6812B	6813B
Number of phases		1	1	1
Output ratings	Power	375 VA	750 VA	1750 VA
	Maximum rms voltage	300 V	300 V	300 V
	Maximum rms current	3.25 A	6.5 A	13 A
	Maximum repetitive peak current	40 A	40 A	80 A
	Crest factor	12	6	6
	Output frequency range	DC; 45 Hz to 1 kHz	DC; 45 Hz to 1 kHz	DC; 45 Hz to 1 kHz
	DC power (watts)	285 W	575 W	1350 W
	DC voltage	±425 V	±425 V	±425 V
	DC current	2.5 A	5 A	10 A

Measurement Accuracy ((25 ± 5 °C) from 45 – 100 Hz in high range where applicable)

		6811B	6812B	6813B
Output ratings	Rms voltage	0.03% + 100 mV	0.03% + 100 mV	0.03% + 100 mV
	Rms current	0.05% + 10 mA	0.05% + 10 mA	0.05% + 10 mA
	Power (VA)	0.1% + 1.5 VA +12 mVA/V	0.1% + 1.5 VA +12 mVA/V	0.1% + 1.5 VA +12 mVA/V
	Power (watts)	0.1% + 0.3 W +1.2 mW/V	0.1% + 0.3 W +1.2 mW/V	0.1% + 0.3 W +1.2 mW/V

¹ For a sinewave with a resistive load

Ordering Information

- 6811B** AC power source/analyzer, 0-300 V_{rms}, 375 VA, single-phase
- 6812B** AC power source/analyzer, 0-300 V_{rms}, 750 VA, single-phase
- 6813B** AC power source/analyzer, 0-300 V_{rms}, 1750 VA, single-phase
- 6813B-019** AC source/analyzer, 0-300 V_{rms}, 2000 VA, single-phase
- 681xB-020** dual power analyzer option

The 6800 Series utilizes a low noise switching topology, which delivers high performance and reduced size. These products can output DC, AC complex, and user-defined waveforms for exceptional application flexibility over the bus.

Key Features

- High peak current capability
- Programmable voltage, frequency, phase, output impedance, distortion, and current limit
- Voltage and frequency slew control
- Power line disturbance simulation
- Avionics power disturbance simulation
- Measurement of V_{rms}, I_{rms}, I_{peak}, frequency, phase, VA, watts, PF, and THD
- Two current measurement ranges. Low range increases sensitivity 10:1
- Harmonic analysis of V and I
- Built-in output isolation relays
- MIL-STD 704 and RTCA DO160 testing capability
- Built-in 26 V_{rms} AUX output option
- Remote shutdown via TTL signal
- Autoranging DC output
- Application specific options

Powerful Direct Digital Synthesis (DDS) Waveform Generation

The 6800 Series offers the ultimate in waveform generation versatility. For testing products under AC line distortion conditions, clipped sine waves can be generated with 0 to 43% distortion. There are a number of methods for creating waveforms; some include inputting harmonic content, phase angles, and data points. These waveforms can be used to generate steady state outputs or can be combined for more complex transient generation schemes.

- 6800 Series
- 6811B
- 6812B
- 6813B

Web Link

www.agilent.com/find/6800



Connecting your device-under-test to clean, stable DC power is a great way to ensure better test results on the bench or in a system. Agilent E3600 Series and U8000 power supplies offer quiet and stable DC power for both manual and automatic testing.

Reliable Power, Repeatable Results – the E3600 Series Power Supplies

The E3600 Series provides low-noise outputs so you can minimize interference and enhance repeatability of your measurements. With stable signal levels and low transients, you get

the output power you need – better and sooner. To fit your application, our range of compact basic supplies is available in bench-friendly and system-ready models. Ultimately, with these power supplies, you get easy access to essential, everyday power sourcing capabilities that will advance your test today and tomorrow – reliably.

More Protection, More Convenience – for Less – the U8000 Series Power Supplies

The U8000 Series offers 90 to 150 W single output, non-programmable DC power supplies

that include features typically found only in costly programmable supplies. The U8000 Series delivers excellent value by providing reliable DC power, efficient setup capabilities, and important security features that let you address a variety of applications in electronics manufacturing and educational settings. As a result, you can minimize setup time and measurement errors and maximize device reliability. You'll get the right power with a difference – backed by stringent safety certifications and Agilent quality standards – at an affordable price.

DC Power Supplies Offerings Summary

Categories	Models	Voltage (max)	Current (max)	Power (max)	No. of ranges	Load and line regulation	Ripple and noise	I/O interface
Single-output manual power supplies	U8001A/U8002A	up to 30 V	up to 5 A	up to 150 W	1	0.01% + 2 mV	12 mVp-p	—
	E3610A/11A/12A	up to 120 V	up to 3 A	30 W	2	0.01% + 2 mV	2 mVp-p	—
	E3614A/15A/16A/17A	up to 60 V	up to 6 A	up to 60 W	1		1 mVp-p	
Multiple-output manual power supplies	E3620A (dual-output) E3630A (triple-output)	up to 25 V up to ±20 V	up to 1 A up to 2.5 A	50 W 35 W	1	0.01% + 2 mV	1.5 mVp-p	—
Single-output programmable power supplies	E3632A/33A/34A	up to 50 V	up to 20 A	up to 200 W		0.01% + 2 mV	best at 2 mVp-p	GPIB, RS-232
	E3640A – E3645A	up to 60 V	up to 8 A	up to 80 W	2	0.01% + 3 mV	best at 5 mVp-p	
Multiple-output programmable power supplies	E3646A – E3649A E3631A	up to 60 V up to ±25 V	up to 5 A	up to 100 W 80 W	1	0.01% + 3 mV 0.01% + 2 mV	best at 5 mVp-p 2 mVp-p	GPIB, RS-232

Web Link

www.agilent.com/find/basicpowersupply

- Single, dual or triple outputs
- Reliable and convenient power for benchtop use
- Enhance measurement results via low-noise output with excellent regulation
- Remote programming and sensing (E3614A/15A/16A/17A)
- Overvoltage protection (OVP) (E3614A/15A/16A/17A)
- Overload protection

These linear-regulated DC power supplies provide reliable and convenient DC power on a lab bench. The 10-turn pots and clear voltage and current meters allow fine adjustments to be made easily. These models are CV/CC, so they can serve as either voltage or current sources. The 'CC Set' button allows the current setting to be viewed, allowing easy adjustment of a current limit. Either the positive or negative terminal may be connected to ground, creating a positive or negative voltage, or floated up to 240 V from ground.

E3610A
E3611A
E3612A
E3614A
E3615A
E3616A
E3617A
U8001A
U8002A
E3620A
E3630A



E3610A – E3617A



U8001A, U8002A

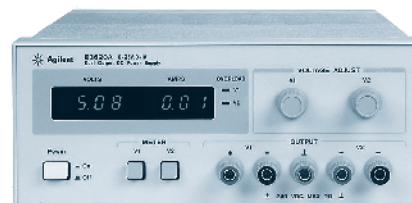

E3620A, E3630A

Specifications (at 0 to 55 °C unless otherwise specified)

		E3610A	E3611A	E3612A	E3614A	E3615A	E3616A	E3617A	U8001A	U8002A	E3620A	E3630A
Number of output		1	1	1	1	1	1	1	1	1	2	3
Number of output ranges		2	2	2	1	1	1	1	1	1	1	1
Output ratings¹	Output 1 Range 1	0 to 8 V, 0 to 3 A ¹	0 to 20 V, 0 to 1.5 A ¹	0 to 60 V, 0 to 0.5 A ¹	0 to 8 V, 0 to 6 A	0 to 20 V, 0 to 3 A	0 to 35 V, 0 to 1.7 A	0 to 60 V, 0 to 1 A	0 to 30 V, 0 to 3 A	0 to 30 V, 0 to 5 A	0 to 25 V, 0 to 1 A	0 to 6 V, 0 to 2.5 A ²
	Range 2	0 to 15 V, 0 to 2 A ¹	0 to 35 V, 0 to 0.85 A ¹	0 to 120 V, 0 to 0.25 A ¹	—	—	—	—	—	—	—	—
	Output 2	—	—	—	—	—	—	—	—	—	0 to 25 V, 0 to 1 A	0 to 20 V, 0 to 0.5 A
Output 3	—	—	—	—	—	—	—	—	—	—	—	0 to –20 V, 0 to 0.5 A
	Power (max.)	30 W	30 W	30 W	48 W	60 W	60 W	60 W	90 W	150 W	50 W	35 W
Load and line regulation		0.01% + 2 mV	0.01% + 2 mV	0.01% + 2 mV	0.01% + 2 mV	0.01% + 2 mV	0.01% + 2 mV	0.01% + 2 mV	0.01% + 2 mV	0.01% + 2 mV	0.01% + 2 mV	0.01% + 2 mV
Ripple and noise (from 20 Hz to 20 MHz)	rms	200 µV	200 µV	200 µV	200 µV	200 µV	200 µV	200 µV	<1 mV	<1 mV	350 µV	350 µV
	peak-to-peak	2 mV	2 mV	2 mV	1 mV	1 mV	1 mV	1 mV	12 V	12 V	1.5 mV	1.5 mV
Resolution (minimum change using front-panel controls)	Voltage	10 mV	100 mV	100 mV	10 mV	10 mV	10 mV	10 mV	10 mV	10 mV	10 mV	10 mV
	Current	10 mA	10 mA	1 mA	10 mA	(0 – 20 V), 100 mV (> 20 V) 10 mA	(0 – 20 V), 100 mV (> 20 V) 1 mA	(0 – 20 V), 100 mV (> 20 V) 1 mA	10 mA	10 mA	(0 – 20 V), 100 mV (> 20 V) 1 mA	10 mA

¹ Maximum current is derated 1% per °C between 40 to 55°C

² Maximum current is derated 3.3% per °C between 40 to 55°C

Ordering Information

- E3610A 30 W single output power supply
- E3611A 30 W single output power supply
- E3612A 30 W single output power supply
- E3614A 48 W single output power supply
- E3615A 60 W single output power supply
- E3616A 60 W single output power supply
- E3617A 60 W single output power supply
- U8001A 90 W single output power supply
- U8002A 150 W single output power supply
- E3620A 50 W dual output power supply
- E3630A 30 W triple output power supply

Web Link

www.agilent.com/find/basicpowersupply
www.agilent.com/find/lowcostpower

E3631A
E3632A
E3633A
E3634A

- **Low ripple and noise with excellent regulation**
- **Remote sensing (except E3631A)**
- **Programmable via GPIB and RS-232**
- **Save/recall up to three states**



E3631A

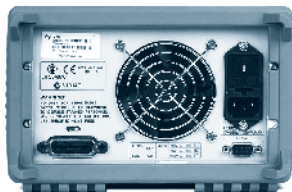

E3632A

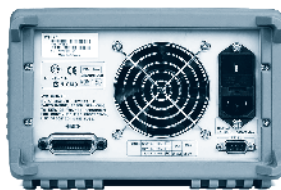

The E3631A is a triple-output programmable DC power supply designed to meet the typical needs of an engineer or electronic technician.

The E3632A (120 W) and E3633A, E3634A (200 W) are single output, dual range programmable DC power supplies designed to deliver reliable and high quality operation at a very attractive price.

Low Noise/Excellent Regulation

0.01% load and line regulation keep the output steady. The linear supply specifies both normal-mode voltage noise and common-mode current noise. The low normal-mode specification assures clean power for precision circuitry and the low common-mode current provides isolation from power line current injection.

Front Panel Operation

Both voltage and current can be monitored simultaneously for output from the front panel on an easy-to-read vacuum fluorescent display.

A knob allows you to set the output at the resolution you need for the most exacting adjustments. Store and recall key enables you to save and recall up to three frequently-used states. The output on/off button enables/disables the output.

Isolated

All the outputs are isolated from the chassis ground and from the remote interface. In the E3631A, 6 V supply is isolated from the ± 25 V supply to minimize any interference between circuits-under-test.

Abbreviated Specifications and Characteristics (at 0 to 55 °C unless otherwise specified)

		E3631A	E3632A	E3633A	E3634A		
DC outputs	Voltage/ current	0 to +25 V/ 0 to 1 A	0 to -25 V/ 0 to 1 A	0 to 6 V/ 0 to 5 A	0 to 15 V, 7 A/ 0 to 30 V, 4 A	0 to 8 V, 20 A/ 0 to 20 V, 10 A	0 to 25 V, 7 A/ 0 to 50 V, 4 A
	Load and line regulation	Voltage Current	< 0.01% + 2 mV < 0.01% + 250 μ A	< 0.01% + 2 mV < 0.01% + 250 μ A	< 0.01% + 2 mV < 0.01% + 250 μ A	< 0.01% + 2 mV < 0.01% + 250 μ A	< 0.01% + 2 mV < 0.01% + 250 μ A
Ripple and noise (20 Hz to 20 MHz)	Normal-mode voltage	< 350 μ V rms/ 2 mV p-p	< 350 μ V rms/ 2 mV p-p	< 350 μ V rms/ 2 mV p-p	< 350 μ V rms/ 2 mV p-p	< 350 μ V rms/ 3 mV p-p	< 500 μ V rms/ 3 mV p-p
	Normal-mode current	< 500 μ A rms	< 500 μ A rms	< 2 mA rms	< 2 mA rms	< 2 mA rms	< 2 mA rms
	Common-mode current	< 1.5 μ A rms	< 1.5 μ A rms	< 1.5 μ A rms	< 1.5 μ A rms	< 1.5 μ A rms	< 1.5 μ A rms
Programming accuracy¹ (25 °C \pm 5 °C)	Voltage/ current	0.05% + 20 mV/ 0.15% + 4 mA	0.05% + 20 mV/ 0.15% + 4 mA	0.1% + 5 mV/ 0.2% + 10 mA	0.05% + 10 mV/ 0.2% + 10 mA	0.05% + 10 mV/ 0.2% + 10 mA	0.05% + 10 mV/ 0.2% + 10 mA
	Readback² accuracy¹ (25 °C \pm 5 °C)	Voltage/ current	0.05% + 10 mV/ 0.15% + 4 mA	0.05% + 10 mV/ 0.15% + 4 mA	0.1% + 5 mV/ 0.2% + 10 mA	0.05% + 10 mV/ 0.15% + 4 mA	0.05% + 10 mV/ 0.15% + 4 mA
Resolution	Program/ readback	1.5 mV, 0.1 mA/ 1.5 mV, 0.1 mA	1.5 mV, 0.1 mA/ 1.5 mV, 0.1 mA	0.5 mV, 0.5 mA/ 0.5 mV, 0.5 mA	1 mV, 0.5 mA/ 0.5 mV, 0.1 mA	1 mV, 1 mA/ 0.5 mV, 1 mA	3 mV, 0.5 mA/ 1.5 mV, 0.5 mA
	Meter	10 mV/1 mA	10 mV/1 mA	1 mV/1 mA	1mV/1 mA	1 mV, 1 mA (< 10 A), 10 mA (\geq 10 A)	1 mV, 1 mA (< 10 A), 10 mA (\geq 10 A)

Transient response time: 50 μ sec for output to recover to within 15 mV following a change in output current from full load to half load or vice versa

¹ Accuracy specifications are valid after a 1-hour warm-up and calibration at 25 °C

² Accuracy refers to readback over GPIB and RS-232 or front panel with respect to actual output

Ordering Information

- E3631A** 80 W triple output power supply
- E3632A** 120 W single output power supply
- E3633A** 200 W single output power supply
- E3634A** 200 W single output power supply

Web Link

www.agilent.com/find/basicpowersupply

- Dual-range outputs
- Remote sensing
- Front and rear output terminals
- Programmable via GPIB and RS-232
- Save/recall up to five states
- Overvoltage protection (OVP) features



E3640A – E3645A

- E3640A
- E3641A
- E3642A
- E3643A
- E3644A
- E3645A
- E3646A
- E3647A
- E3648A
- E3649A

These isolated dual range DC power supplies provide the stable and reliable DC power that the manufacturing test system designer needs. These models offer constant-voltage/constant-current outputs, so they can serve as either voltage or current sources. They can be used either for manual or automated testing and have VXI Plug & Play drivers to further simplify computer control.

The E3640A Series DC power supplies can be quickly integrated into a test system. Both front and rear panel terminals are provided for easy wiring. Remote sensing eliminates the errors in voltage regulation due to voltage drops in the load leads. Delicate DUTs are protected by overvoltage protection. Up to 5 operating states can be stored.

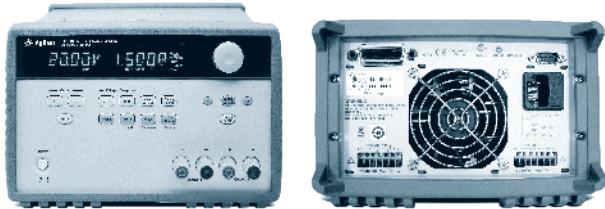

3646A – E3649A

Abbreviated Specifications and Characteristics (at 0 to 55 °C unless otherwise specified)

Model number	E3640A	E3641A	E3642A	E3643A	E3644A	E3645A
Maximum power	30 W	30 W	50 W	50 W	80 W	80 W
# of output	1	1	1	1	1	1
Output ratings	0 to 8 V/3 A 0 to 20 V/1.5 A	0 to 35 V/0.8 A 0 to 60 V/0.5 A	0 to 8 V/5 A 0 to 20 V/2.5 A	0 to 35 V/1.4 A 0 to 60 V/0.8 A	0 to 8 V/8 A 0 to 20 V/4 A	0 to 35 V/2.2 A 0 to 60 V/1.3 A

Model number	E3646A	E3647A	E3648A	E3649A
Maximum power	60 W	60 W	100 W	100 W
# of output	2	2	2	2
Output ratings	0 to 8 V/3 A 0 to 20 V/1.5 A	0 to 35 V/0.8 A 0 to 60 V/0.5 A	0 to 8 V/5 A 0 to 20 V/2.5 A	0 to 35 V/1.4 A 0 to 60 V/0.8 A

Common to all models		
Load and line regulation ±(% of output + offset)	Voltage	< 0.01% + 3 mV
	Current	< 0.01% + 250 µA
Ripple and noise (20 Hz to 20 MHz)	Normal mode voltage	< 5 mVpp/0.5 mVrms for 8 V/20 V models; < 8 mVpp/1 mVrms for 35 V/60 V models;
	Normal mode current	< 4 mArms
	Common mode current	< 1.5 µArms
Accuracy 12 months (@ 25 °C ± 5 °C), ±(% output + offset)	Programming	
	Voltage	< 0.05% + 10 mV (< 0.1% + 25 mV for output 2 of E3646/47/48/49A)
	Current	< 0.2% + 10 mA
	Readback	
Resolution	Voltage	< 0.05% + 5 mV (< 0.1% + 25 mV for output 2 of E3646/47/48/49A)
	Current	< 0.15% + 5 mA (< 0.15% + 10 mA for output 2 of E3646/47/48/49A)
Resolution	Program	< 5 mV/1 mA
	Readback	< 2 mV/1 mA
	Meter	10 mV/1 mA

Transient response: Less than 50 µsec for output to recover to within 15 mV following a change in output current from full load to half load or vice versa

Ordering Information

- E3640A 30 W single output power supply
- E3641A 30 W single output power supply
- E3642A 50 W single output power supply
- E3643A 50 W single output power supply
- E3644A 80 W single output power supply
- E3645A 80 W single output power supply
- E3646A 60 W dual output power supply
- E3647A 60 W dual output power supply
- E3648A 100 W dual output power supply
- E3649A 100 W dual output power supply

Web Link

www.agilent.com/find/basicpowersupply

Overview

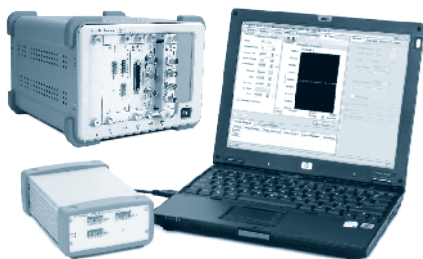

U2722A/U2723A USB modular SMU with U2781A USB modular product chassis



E526xA/E5270B modular SMU Series



N6702A low-profile MPS mainframe

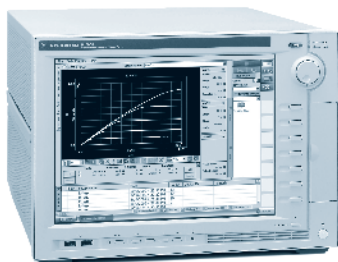

B1505A power device analyzer/curve tracer

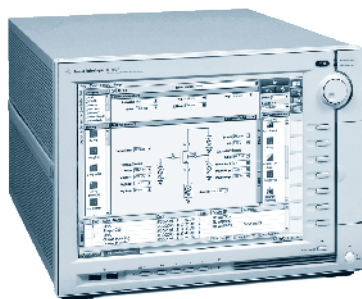

B1500A semiconductor device analyzer



N6705B DC power analyzer

The SMU (source measure unit) is a measurement resource for test applications requiring high accuracy, high resolution and measurement flexibility. SMUs are also referred to as source monitor units, and both definitions are essentially the same. An SMU can force voltage or current and simultaneously measure voltage or current. The diagram below shows a simplified SMU equivalent circuit:

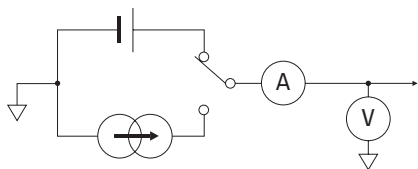

SMU equivalent circuit

Agilent Technologies provides a wide variety of SMU products, and they are categorized in three families: 4-quadrant general purpose USB modular SMUs, 2-quadrant SMU modules, and precision SMUs.

4-Quadrant General Purpose USB Modular SMU

The Agilent U2722A/U2723A USB modular source measure unit is more than just a power supply – it has fast response time, voltage and current programming/readback with high accuracy measurement capabilities. The U2722A and its enhanced version, the U2723A are capable of four-quadrant operation, acting as current source and also as current sink (load) with both polarities of the output voltage.

The U2723A offers additional features such as embedded test scripts to simply automated testing and faster rise time to help improve throughput during mass testing of semiconductor components.

Precision SMU Family

The precision SMU technology available in this family has made possible significant advancements in semiconductor technology. The Agilent semiconductor parameter/device analyzer Series (B1500A, 4155C and 4156C) offers a variety of options to meet a wide range of parametric measurement needs. The modular SMU Series (E5260A Series and E5270B) provides solutions for both precision device characterization and high-speed production test. The Agilent power device analyzer/curve tracer (B1505A) enables high voltage and high current measurements (up to 3,000 V or 40 A).

N6700 SMU Module Family

The Agilent N6780 Series, 2 & 4-quadrant SMUs offer advanced sourcing and measurement capabilities required to overcome test challenges associated with optimizing power consumption and maximizing battery life of battery-powered devices and their components. The new SMUs are modules that can be used with the N6700 low-profile mainframes for automated test and the N6705 DC power analyzer mainframe for R&D.

4-Quadrant General Purpose USB Modular SMU

Model	Key application	Key feature	Voltage		Current		Channels
			Maximum force voltage	Measurement resolution	Maximum force current	Measurement resolution	
U2722A USB modular source measure unit	Device and component test	4-quadrant operations, flexible standalone or modular capability with U2781A USB chassis	±20 V	100 µV	±120 mA	100 pA	3
U2723A USB modular source measure unit	Device and component test	4-quadrant operations, flexible standalone or modular capability with U2781A USB chassis, IV curve application support in the Agilent Measurement Manager software, embedded test scripts, two memory lists with 200 commands storage for each channel	±20 V	100 µV	±120 mA	100 pA	3

N6700 SMU Module Family

Model	Key application	Key feature	Voltage		Current		Channels	Page
			Maximum force voltage	Measurement resolution	Maximum force current	Measurement resolution		
N6781A 2-quadrant SMU for battery drain analysis	Battery drain analysis of portable devices	2-quadrant 20 W SMU module for the N6705B and N6700 mainframes	20 V	1 µV	±3 A	100 pA	1 per module, up to 4 per mainframe	228
N6782A 2-quadrant SMU for functional test	Functional test of power devices	2-quadrant 20 W SMU module for the N6705B and N6700 mainframes	20 V	1 µV	±3 A	100 pA	1 per module, up to 4 per mainframe	228
N6784A 4-quadrant GP SMU	General purpose source/measure	4-quadrant 20 W SMU module for the N6705B and N6700 mainframes	±20 V	1 µV	±3 A	100 pA	1 per module, up to 4 per mainframe	228

Precision SMU Family

Model	Key application	Key feature	Voltage		Current		Channels	Page
			Maximum force voltage	Measurement resolution	Maximum force current	Measurement resolution		
B1500A semiconductor device analyzer	Advanced device characterization	CMU (capacitance measurement unit), pulse generator unit, WGFMU (waveform generator/fast measurement unit), PC based EasyEXPERT software and touch panel, prober control	±200 V	0.5 µV	±1 A	0.1 fA	10	169
B1505A power device analyzer/curve tracer	High power device characterization	CMU (capacitance measurement unit), PC based EasyEXPERT software and touch panel, prober control	±3000 V	0.2 µV	±40 A	10 fA	5	170
4155C semiconductor parameter analyzer	Device characterization	Fill-in-the-blanks front panel operation, optional expander box for pulse generator, desktop EasyEXPERT software on external PC	±200 V	0.2 µV	±1 A	10 fA	4 (Fixed)	171
4156C precision semiconductor parameter analyzer	Device characterization	Fill-in-the-blanks front panel operation, optional expander box for pulse generator, desktop EasyEXPERT software on external PC	±200 V	0.2 µV	±1 A	1 fA	4 (Fixed)	171
E5260A 8-slot high speed measurement mainframe	Device and component test	High speed measurement, code compatible with popular 4142B, 16 digital I/O lines, built-in program memory	±200 V	100 µV	±1 A	5 pA	8	172
E5262A 2-channel high speed source monitor unit	Device and component test	Low cost high speed measurement, code compatible with popular 4142B, 16 digital I/O lines, built-in program memory	±100 V	100 µV	±200 mA	5 pA	2 (Fixed)	172
E5263A 2-channel high speed source monitor unit	Device and component test	Low cost high speed measurement, code compatible with popular 4142B, 16 digital I/O lines, built-in program memory	±200 V	100 µV	±1 A	5 pA	2 (Fixed)	172
E5270B 8-slot precision measurement mainframe	Device characterization	Precision measurement with ASU (atto-sense and switch unit), code compatible with popular 4142B, 16 digital I/O lines, built-in program memory	±200 V	0.5 µV	±1 A	0.1 fA	8	173

Web Link

www.agilent.com/find/smu

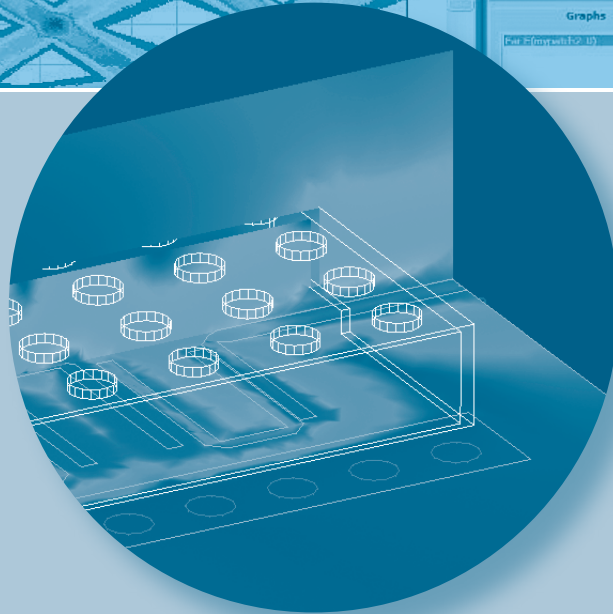
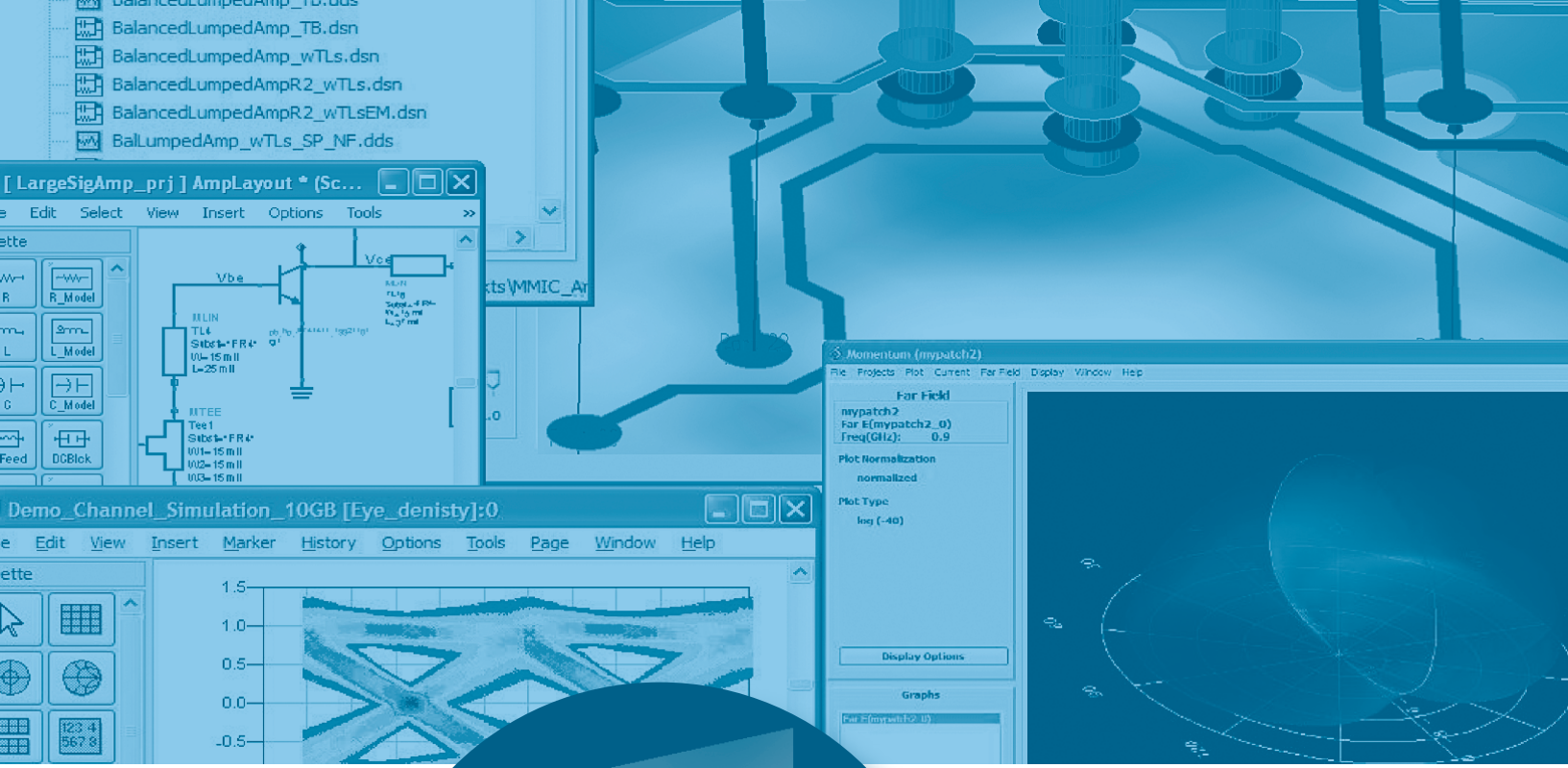

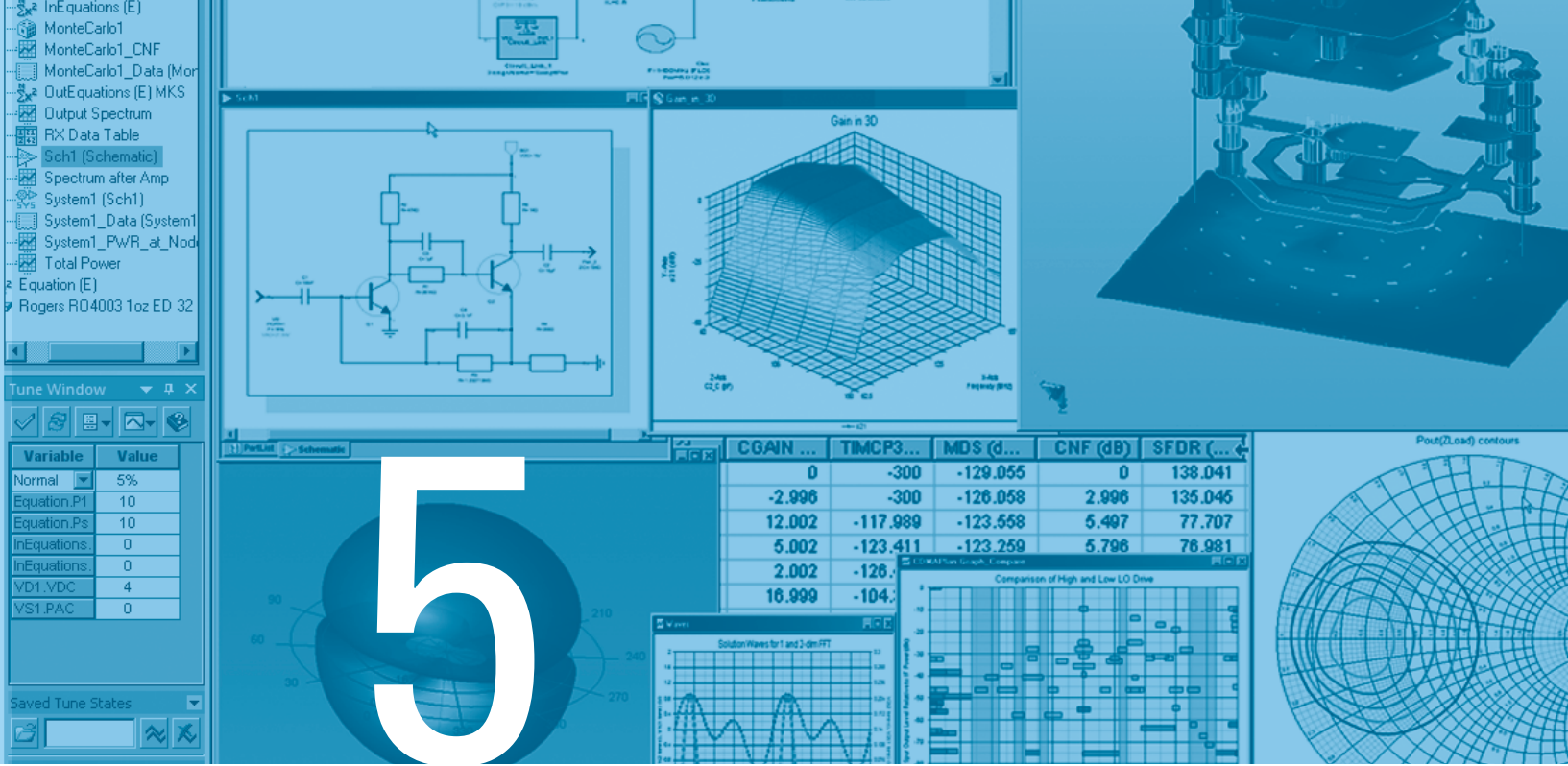

Software

EEsof EDA Design and Simulation Software
 Agilent VEE

244
 250

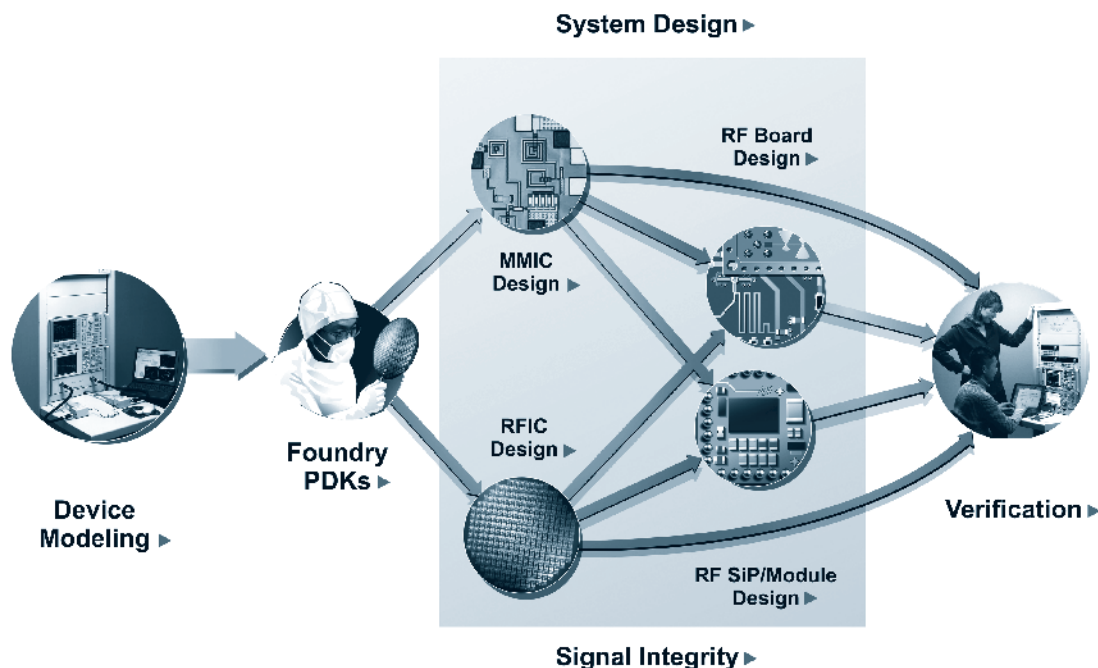

Agilent EESof EDA is the leading supplier of electronic design automation (EDA) software for high-frequency and high-speed system, modeling, and RF circuit design applications. These applications include signal integrity as well as RF and microwave amplifier, mixer and filter design for commercial wireless, aerospace and defense markets.

Agilent EESof EDA products include the Advanced Design System EDA software, IC-CAP device modeling software, Momentum, EMPro 3D electromagnetic simulation software, GENESYS, SystemVue, and GoldenGate RFIC simulation software.

World-Class Products to Enable the High-Frequency Design Chain, from Device Modeling through Verification

- *Advanced Design System (ADS)* is a powerful electronic design automation software platform. It offers complete design integration to designers of products such as cellular and portable phones, wireless networks, and radar and satellite communications systems. ADS now addresses the needs of high-speed digital designers with its signal integrity simulation technology.

- *Electromagnetic professional (EMPro)* is a software design platform for analyzing the 3D electromagnetic (EM) effects of components such as high-speed and RF IC packages, bondwires, antennas, on-chip and off-chip embedded passives and PCB interconnects. EMPro features a modern design, simulation and analysis environment, high capacity simulation technologies and integration with the industry's leading RF and microwave circuit design environment, advanced design system (ADS) for fast and efficient RF and microwave circuit design.
- *Agilent GoldenGate* is an RFIC simulator delivering high capacity and unique analysis for full chip verification and design for yield. Developed for the specific needs of RFIC designers. Fully integrated in the cadence analog design environment.
- *Momentum* is a 3D planar electromagnetic (EM) simulator used for passive circuit analysis. It accepts arbitrary design geometries (including multi-layer structures) and accurately simulates complex EM effects including coupling and parasitics. And because momentum is an integrated component in the advanced design system (ADS) design flow, simulation setup times are reduced, and design productivity is increased.

- *GENESYS* is an affordable, easy-to-use, integrated electronic design automation (EDA) software package focused on RF and microwave circuit and system design. GENESYS is available in standalone configurations, but is also affordable enough that its unique capabilities can augment a variety of existing RF EDA toolsets with new capability.
- *SystemVue* is a fast, easy to learn development tool for design, simulation and analysis of communications architectures and signal processing algorithms. SystemVue has an easy to learn, intuitive block level design interface with extensive model libraries of bit-true fixed point elements, communications system building blocks, adaptive control elements, and digital signal processing components. SystemVue supports algorithm prototyping and implementation via VHDL generation for FPGAs and ANSI C-Code for embedded DSP.
- *IC-CAP (integrated circuit characterization and analysis program)* is a parameter extraction and device modeling software package that provides powerful characterization and analysis capabilities for all of today's semiconductor modeling processes.

Web Link

www.agilent.com/find/eesof
www.agilent.com/find/eesof-evaluation

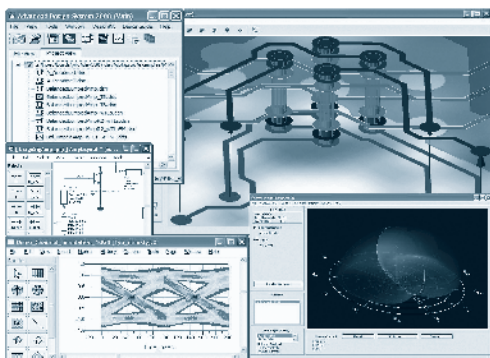

Advanced Design System is the leading electronic design automation software for RF, microwave, and signal integrity applications, providing the design simulation software environment that enables the co-design of IC, package, and board in high frequency and high-speed applications. ADS has pioneered the most innovative and commercially successful technologies, including the industry's most advanced suite of system, circuit, and EM simulation products, and the recently introduced X-parameters, a breakthrough in non-linear modeling. ADS seamlessly integrates these powerful tools in a complete front to back design platform, taking you every step from concept to manufacturing, making it the choice of leading companies in the wireless communication & networking and aerospace & defense industries.

The Industry's Leading Technology, and Much More

ADS puts an unparalleled suite of simulation technology at your fingertips including S-parameter, AC analysis, harmonic balance, high frequency SPICE, convolution, circuit envelope, high speed channel, ptolemy system dataflow, Momentum 3D planar EM, and finite element, but that is only the beginning.

High quality models are critical to design productivity. ADS has models for every microwave and RF design application, including RF system models (mixers, filters, modulators, PLL's, etc.), a full portfolio of highly accurate passive component models (transmission lines, resistors, capacitors, etc.), and a variety of design libraries for standards compliant design (3G, WLAN, EDGE, and UWB). Adding to this is the latest innovation from Agilent, X-parameters, which provide breakthrough, non-linear model extraction from both Agilent instruments and ADS.

Agilent also works with top foundries around the world to develop and support process design kits for RFIC and MMIC design in ADS. Finally, all the major component vendors provide up-to-date component libraries, representing thousands of models, specifically for ADS.

To shorten your design cycles, ADS provides a huge amount of application-specific data. There are over 300 examples covering everything from specific application circuits to tutorials on how to get the most out of ADS. Through design guides, we have integrated the experience and best practices of leading designers. They provide wizards, pre-configured set-ups and displays, and step-by-step instructions for design applications such as amplifiers, filters, mixers, RF systems, etc., giving you easy access to the power of ADS from day 1.

Boost Productivity with an Integrated Design Environment

ADS integrates all this proven RF, signal integrity, mixed-signal and electromagnetic technology into a single, flexible environment. Additionally, ADS works with other EDA frameworks to fit well with your specific design flow, and with the ADS instrument connectivity, it provides a truly unique integration of design and measurement.

This proven software environment is easily customized to meet your unique design or application needs. ADS run on PCs and workstations, with complete file compatibility between platforms and across networks.

ADS Product Configuration Options

ADS now has a new, simplified product structure making it easier than ever to find your ideal configuration. This new structure includes the ADS core, ADS bundles, and Elements. ADS core (W2200) is the foundation for your product configuration. Previously sold separately,

the combined capabilities in ADS core assure you the best value in RF design capabilities available anywhere. The major elements of this new ADS core bundle include:

- Project design environment to manage design projects and launch simulations
- Data display to post-process, analyze, and plot simulation results data
- Linear simulator for S-parameters, DC and small signal AC analysis
- RF system simulator
- Statistical simulator including powerful design-of-experiments (DOE) for ensuring robust designs
- Thirteen powerful optimizers to maximize your designs performance and yield
- Filter design guide to synthesize lumped and distributed filters
- Passive circuit design guide to synthesize matching networks and passive functions
- Design guide developer studio for you to create customized design guides
- Additional model libraries – RF system, RF passive and multilayer interconnects
- Dynamic link to cadence for simulating Composer RFIC schematic in ADS
- Bidirectional RF design transfer with leading PCB design tools
- Connection manager for bidirectional data transfer with Agilent test instrumentation

Building on the ADS core are Agilent's new ADS design bundles, providing pre-configured combinations of software targeted to a specific design workflow. These combinations provide technologies targeting GaAs MMIC, RFIC, RF system-in-package (SiP), RF board and signal integrity design. Here are just a few examples:

W2205 – this bundle includes the industry leading 3D-planar momentum EM simulator is at a fraction of the price for a standalone tool. The focus is on front to back designs of MMICs, Modules, and PCBs. Capabilities include:

- Harmonic balance – for analysis of non-linear circuits excited with multi-tone sources, for design of amplifier, RF, microwave, oscillator and custom circuits
- Layout – comprehensive physical design environment specifically geared for high-frequency circuit development
- Artwork translators for DXF, Gerber, IGES and GDS-II formats
- Momentum G2 – 3-D planar electromagnetic (EM) simulation of passive circuits. Provides circuit co-simulation, optimization and animated display of current flow

WW2211 – this is one of the bundles focused on signal integrity analysis. It provides key channel simulation capabilities as well as integration with EM simulation for accurate modeling of high speed digital circuitry.

- Transient convolution – advanced time-domain simulator that includes IBIS I/O models, signal integrity verification, broadband and high-frequency SPICE simulation
- Layout – comprehensive physical design environment specifically geared for high-frequency circuit development
- Artwork translators for DXF, Gerber, IGES and GDS-II formats
- Momentum G2 – 3-D planar electromagnetic (EM) simulation of passive circuits. Provides circuit co-simulation, optimization and animated display of current flow

Web Link

www.agilent.com/find/eesof-ads

www.agilent.com/find/eesof-ads-evaluation

W2401
W2402
W2403
W2404
W2405
W2342

- **Design flow integration: create 3D components that can be simulated with 2D circuit layouts and schematics within advanced design system (ADS)**
- **Multiple simulation technologies: finite element method (FEM) and finite difference time domain (FDTD)**
- **Efficient user interface: quickly create arbitrary 3D structures with a modern, simple GUI that saves time and provides advanced scripting features**

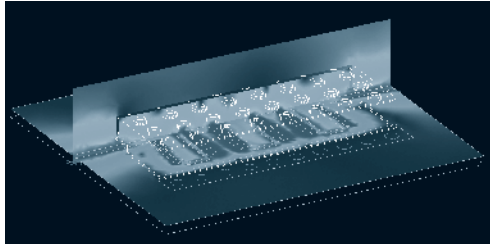

EMPro simulates 3D electromagnetic fields for a wide range of applications such as this shielded microwave filter design

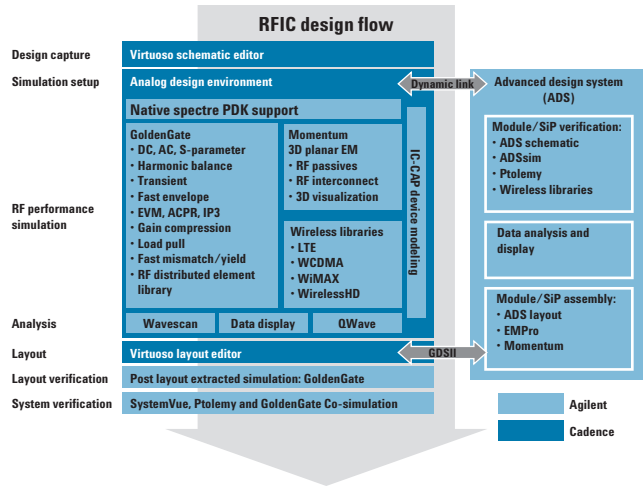

EEsof EDA Design and Simulation Software

Electromagnetic professional (EMPro) is Agilent EEsof EDA’s software design platform for analyzing the 3D electromagnetic (EM) effects of components such as high-speed and RF IC packages, bondwires, antennas, on-chip and off-chip embedded passives and PCB interconnects. EMPro features a modern design, simulation and analysis environment, high capacity simulation technologies and integration with the industry’s leading RF and microwave circuit design environment, advanced design system (ADS) for fast and efficient RF and microwave circuit design.

Specifications

Modern, efficient 3D solid modeling environment

- Arbitrary 3D objects can be created from scratch or from existing templates
- CAD files can be imported, modified and simulated
- Powerful Python scripting provides advanced automation
- Linux and Windows support

Integration with ADS design flow

- Parameterized 3D components can be exported and simulated together with schematics/layouts in ADS
- Layout objects can be imported from ADS

Frequency domain simulation

- Finite element method (FEM) simulation engine
- Best for typical RF/microwave component simulations
- Direct and iterative solvers for different applications
- Same FEM engine can be launched from both EMPro and ADS

Time domain simulation

- Finite difference time domain (FDTD) simulation engine
- Best for electrically large problems, such as antenna simulations and signal integrity applications
- Compliance testing option available for regulatory analyses such as specific absorption rate (SAR)
- Graphical processor unit (GPU) acceleration option available for dramatic speed and capacity improvement

Ordering Information

EMPro bundles

EMPro elements	W2402B	W2403B	W2404B
W2401 EMPro core element	•	•	•
W2342 Agilent FEM simulator element	•	—	•
W2405 Agilent FDTD simulator element	—	•	•

GoldenGate provides the framework for RFIC designers to rapidly simulate circuits, verify specs and validate potential yield. Designers can confidently simulate blocks, combinations of blocks and full receive/transmit chains to understand the negative influences introduced by noise, distortion, parasitics and numerous other effects confronted in modern RFIC design. Additionally, designers can analyze the manufacturability of circuits by using industry proven techniques such as monte carlo and process corner boundaries.

GoldenGate combines Agilent’s leading wireless and wireline simulation technologies, model sets, and waveform viewing capabilities. These outstanding tools provide a comprehensive circuit simulation methodology that has been masterfully integrated into the cadence analog design environment. Designers can move smoothly through schematic capture, test bench setup, simulation and analysis to achieve amazing insight into design performance and manufacturability prior to tape out, avoiding costly mistakes and design re-spins.

Improved Design Productivity

As data rates, carrier frequencies, and specification complexities increase, so does the designer’s need to utilize a broader range of fast and accurate EDA tools. Agilent’s extensive set of RFIC simulation, mixed-domain simulation, statistical design, optimization, and post-simulation analysis capabilities ease the design challenge from within the familiar Cadence framework. No matter what the design standard, circuit, or requirement, adding Agilent GoldenGate to the design flow reduces costly design iterations and shortens design cycles.

Complete RF/Mixed-Signal IC Design Flow

GoldenGate is part of a comprehensive RF/MS IC design flow which originates at design capture and flows seamlessly to prototype test. Designs initially are created in cadence virtuoso schematic composer. Circuits are then simulated in GoldenGate directly from the schematic, enabling smooth transition from schematic capture to simulation. Advanced simulation options, including optimization, parameter sweeps, pre-configured measurements, and statistical analysis provide a “real-world” view of performance and yield. Simulation results are viewed using Agilent’s rich set of data display capabilities.

After the IC layout is complete, extracted parasitics can be re-simulated and analyzed within GoldenGate. Additional parasitic and passive layout component modeling is performed using the ADS momentum and momentum RF simulators. Co-simulation with the Agilent ptolemy system simulator is used to verify that overall system behavior matches specification. Final prototype measurements, and additional circuit and device modeling, are performed with Agilent test equipment and IC-CAP software.

Web Link

www.agilent.com/find/eesof-empro
www.agilent.com/find/eesof-empro-evaluation

Web Link

www.agilent.com/find/eesof-goldengate
www.agilent.com/find/eesof-goldengate-evaluation

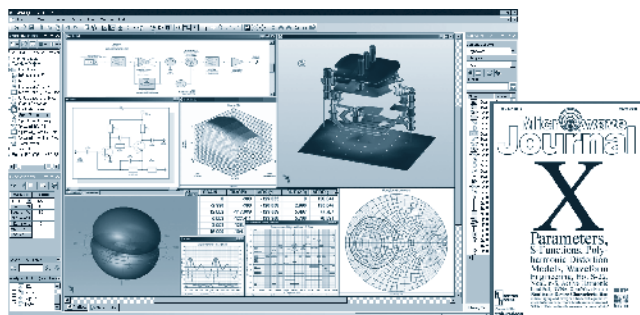

Agilent genesys is the low cost, high performance RF/microwave board and RF system simulation software with more than 5,000 users worldwide

Agilent Genesys is a low cost, high performance electronic-design-automation (EDA) software for RF/microwave board and RF system design. It leads the industry in unbeatable price-performance, starting at \$3,700 and features advanced technology such as:

- X-parameter simulation
- Broadest coverage of circuit synthesis capabilities
- Fastest method of moment electromagnetic simulator (momentum GXF)

The starting genesys core bundle is already very full featured with integrated schematic capture, linear and statistical simulators, optimizers, data plotting, MathLang data analysis, RF layout, extensive parts libraries, and links to test instrumentation.

Genesys Simple Product Configuration

Genesys is available in 9 feature-rich but affordable bundles that extends genesys core with powerful building blocks for:

- Filter and matching network synthesis
- Complete synthesis for passive and active components
- Nonlinear circuit time and frequency domain simulation with X-parameters
- System architecture and frequency planning simulation with X-parameters
- Fast, high-capacity planar 3D electromagnetic simulation (momentum GXF) for board layout

To select an affordable, but powerful genesys bundle, go to www.agilent.com/find/eesof-genesys-config-guide, from where you can also get a quick quote and download the latest genesys brochure.

- W1320BP
- W1321BP
- W1322BP
- W1323BP
- W1324BP
- W1325BP
- W1326BP
- W1327BP
- W1328BP
- W2362EP

Genesys bundle name:	Genesys core	Genesys core, filter, match	Genesys core, synthesis	Genesys core, system	Genesys core, synthesis, circuit	Genesys core, synthesis, EM	Genesys core, synthesis, circuit, system	Genesys core, synthesis, circuit, EM	Genesys core, synthesis, circuit, system, EM	ADS RF architect and synthesis element
Environment										
Genesys core environment	•	•	•	•	•	•	•	•	•	•
Testlink	•	•	•	•	•	•	•	•	•	•
Synthesis										
Filter		•	•		•	•	•	•	•	•
M/filter		•	•		•	•	•	•	•	•
Match		•	•		•	•	•	•	•	•
Advanced Tline		•	•		•	•	•	•	•	•
S/filter			•		•	•	•	•	•	•
A/filter			•		•	•	•	•	•	•
Equalize			•		•	•	•	•	•	•
Oscillator			•		•	•	•	•	•	•
PLL			•		•	•	•	•	•	•
Signal control			•		•	•	•	•	•	•
Mixer			•		•	•	•	•	•	•
Circuit simulation										
Harbec					•		•	•	•	
Cayenne					•		•	•	•	
Advanced modeling kit					•		•	•	•	
System simulation										
Spectrasys							•	•	•	•
WhatIF							•	•	•	•
EM simulation										
Momentum GXF						•		•	•	
Momentum GX						•		•	•	
EMpower						•		•	•	
Sonnet link						•		•	•	
Training class										
N3244A/B genesys 3-day hands-on training										Don't forget to sign up for training!

Web Link

- www.agilent.com/find/eesof-genesys
- www.agilent.com/find/eesof-genesys-brochure
- www.agilent.com/find/eesof-genesys-evaluation

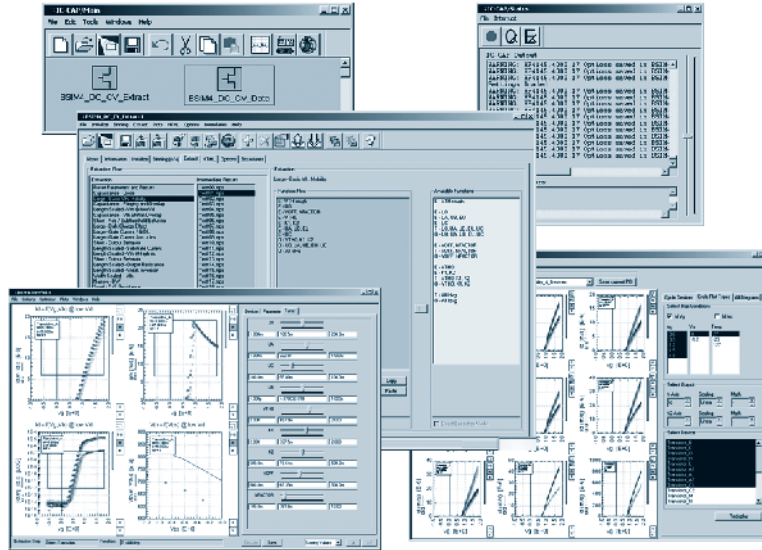

IC-CAP is a device modeling program that provides powerful characterization and analysis capabilities for all of today's semiconductor modeling processes.

IC-CAP offers device engineers and circuit designers state-of-the-art modeling software that performs numerous modeling functions including instrument control, data acquisition, graphical analysis, simulation, optimization, and statistical analysis.

All of these processes are combined into a flexible and intuitive Windows style software environment for efficient and accurate extraction of active device and circuit model parameters. IC-CAP also provides the power to build model libraries for Agilent EEsof's ADS and other simulators.

A Complete Device Modeling Solution

Successful device modeling requires thorough understanding of the complex integration between the measurement hardware and the modeling software. IC-CAP provides a complete set of tools for a fully integrated solution for device modeling engineers.

Extraction Modules

The device modeling world comprises a wide variety of technologies, each having its own particular application focus. IC-CAP provides complete model extraction solutions along with convenient user interfaces and extraction methodologies.

IC-CAP actively supports the following modeling technologies:

- CMOS
- HBT
- BJT
- FET
- HEMT
- Custom model developments
- Diode
- 1/f Noise

The Most Efficient CMOS Modeling Solutions on a Single Platform

An efficient device modeling flow is the critical path to any foundry's success. Time, money, and customer share can be compromised if there are problems in this process.

IC-CAP is the first modeling tool to provide a comprehensive family of extraction solutions for all three compact modeling council (CMC) standard CMOS device models, BSIM3, BSIM4 and PSP, on a single platform. IC-CAP's unified measurement approach allows data from one technology to be used for extraction in the next without having to take new measurements, assuming there are no additional measurements required. This single platform approach to CMOS modeling facilitates smooth, risk free transitions from one model technology to the next.

In addition to the advantage of a single platform, IC-CAP users save time and effort with an efficient, intelligent, direct extraction methodology. Dramatic reductions in extraction time can be experienced with the IC-CAP CMOS model extraction packages. The BSIM4 extraction package has demonstrated a 2 day model extraction that is accurate and physically based. This is significant reduction from the typical 14 day extraction.

5



Measurement

IC-CAP software provides the most advanced modeling measurement capabilities with the new W8510 IC-CAP Wafer Professional (WaferPro).

IC-CAP WaferPro enables efficient DC, CV and RF on wafer automated measurements across temperature. The IC-CAP WaferPro solution can efficiently control DC/CV analyzers, network analyzers, probes, switching matrixes as well as the powerful 407x and 408x Series of Agilent parametric testers.

Web Link

www.agilent.com/find/eesof-iccap

www.agilent.com/find/eesof-iccap-evaluation

Agilent SystemVue (standalone environment)

- RF/DSP co-design for superior system-level partitioning
- Polymorphic modeling in C++, math, VHDL, or behavioral blocks
- Distortion-true RF models, with X-parameter support
- Fixed-point and HW design kits for HDL (FPGA) and C++ (DSP)
- PHY reference libraries for LTE, 60 GHz WPAN, OFDM, more
- Creative of integration RF/BB simulation with measurements

RF verification in ADS and GoldenGate (ptolemy)

- Verify RF designs against system-level measurements
- Use realistic modulated signal conditions, with links to test
- Verification personalities for 3GPP-LTE, WLAN, Cellular, WiMAX

Agilent spectrasys

- Accurate and fast RF system analysis
- Quickly diagnose root causes of poor system performance
- Easy like a spreadsheet, but handles many more effects
- Full nonlinear RF and noise modeling, with X-parameters

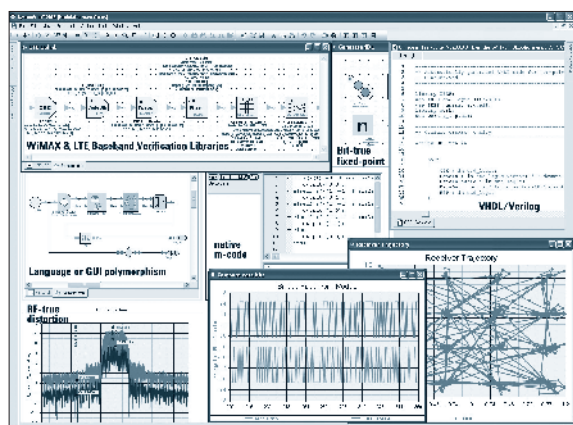

SystemVue brings higher quality RF models, channel

Agilent EESof EDA provides a full range of electronic system-level (ESL) design, analysis, implementation, and verification tools.

Agilent SystemVue

Agilent SystemVue is a dedicated electronic design automation (EDA) environment for electronic system-level (ESL) design. It enables system architects and algorithm developers to innovate the physical layer (PHY) of wireless and aerospace/defense communications systems and provides unique value to RF, DSP, and FPGA/ASIC partitioning and implementation. As a dedicated platform for ESL design and signal processing realization, SystemVue replaces general-purpose digital, analog, and math environments that lack the specialization for high-performance systems. SystemVue "speaks RF", cuts PHY development and verification time in half, and connects directly into your enterprise EDA flow.

Agilent ADS Ptolemy

Agilent ADS ptolemy is a dataflow simulator specifically geared for RF component designers. It is integrated natively into the advanced design system and provides a simulation "backplane" for advanced RF-DSP co-verification. Ptolemy allows RF designers to surround analog physical designs with system-level intelligence, signal conditions, and measurements, so that they can quickly verify that their 3-dimensional RF board, MMIC/RFIC, SiP, and module designs interoperate with established wireless standards, as well as proprietary IP. ADS ptolemy forms a simulation bridge to Agilent SystemVue, C++, .m files, VHDL/Verilog and test & measurement equipment. Verification libraries are available for a variety of wireless standards, including WLAN, WiMAX, 3GPP/GSM/EDGE, and 3GPP-LTE. Also integrated with GoldenGate simulation in the cadence virtuoso environment.

Agilent Spectrasys

Agilent Spectrasys provides subsystem design, analysis, and debug tools for RF system architects that are unmatched by any other technology. Unlike spreadsheet-based tools, Spectrasys is graphical and accounts for a much greater level of physical detail and analog performance issues that spreadsheets assume away – such as mismatch effects, intermodulation terms, reverse propagation, SSB noise, phase noise, nonlinear effects, and X-parameters with loadpull variation. Spectrasys is also superior to time-domain dataflow simulators, math engines, and many spice-like simulators in that it accounts for a wide variety of analog distortions and interactions while being lightning fast and easy to use. Spectrasys is available in the SystemVue and genesys platforms.

Ordering Information**SystemVue configurations**

- W1461 SystemVue communications architect
- W1462 SystemVue FPGA architect
- W1464 SystemVue RF system architect
- W1465 SystemVue system architect (recommended)

SystemVue application personalities

- W1903 fixed-point library
- W1904 adaptive equalization library
- W1714 AMI modeling kit
- W1715 MIMO channel builder
- W1716 digital pre-distortion builder
- W1717 hardware design kit
- W1718 C++ code generator
- W1719 RF system design kit (spectrasys)

SystemVue baseband "golden reference" IP libraries

- W1905 radar model library
- W1910 LTE baseband verification
- W1911 WiMAX baseband verification
- W1914 DVB-2 baseband verification
- W1915 mmWave WPAN baseband verification
- **OFDM and zigbee included free with SystemVue

Agilent ADS (Ptolemy for RF verification)

- W2361 ptolemy element (adds onto ADS or GoldenGate)
- W2366 integrated wireless libraries
- W2368 3GPP-LTE wireless library

Spectrasys bundles

- W1323 genesys core + spectrasys (for genesys users)
- W1464 RF system architect (for SystemVue, ADS, GoldenGate users)

Web Link

www.agilent.com/find/eesof-systemvue

www.agilent.com/find/eesof-systemvue-evaluation

W4000B-PRO
W4000B-EXP
W4000B-STU
W4000B-ED1

- **Microsoft Windows 7 compatibility**
- **Multithreading and multicore programming support**
- **SCPI completion**
- **Conditional breakpoints and breakpoints Window**
- **LXI support**
- **Private UserFunction**
- **Error call stack**

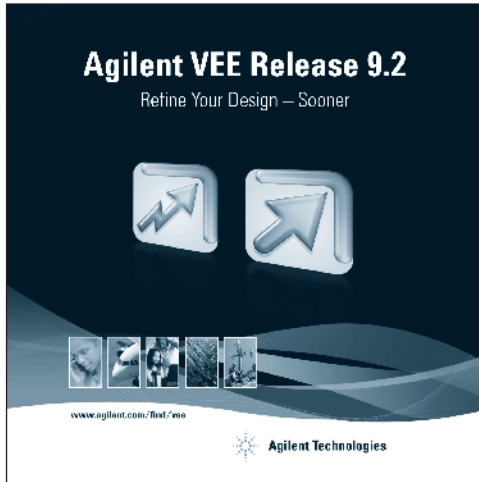

Agilent VEE

Easy to Learn and Use

Agilent VEE provides high-level, task-oriented programming with graphical objects.

Simply create objects in the form of block diagrams using pull-down menus – and link them with wires that define the program flow. Programming tasks that would require hundreds of lines of code in a typical text-based language are simplified into a few high-level objects, rapidly reducing development time. Agilent VEE includes built-in tutorials and more than 700 sample programs to help you learn perform programming quickly.

Powerful Tools to Increase Productivity

Agilent VEE is designed for test and measurement with its set of powerful test executive tools. It automatically handles different data types, providing automatic conversion and giving you efficient data handling capabilities with minimum programming. The hundreds of built-in functions include:

- Direct I/O object provides access instrument registers and advanced functionality such as service request and serial poll
- Built-in profiler enables analysis of critical sections of code to save development time
- 1800 MATLAB functions and 1000 built-in MATLAB analysis and visualization functions

Works Seamless with Agilent and non-Agilent Hardware and Software

Agilent VEE's instrument manager provides capability to automatically detect Agilent and non-Agilent instruments, helping you to begin measurement and analysis tasks in no time. Agilent VEE can interact with data acquisition cards or measurement using GPIB, LAN, LXI, USB, GPIO. Agilent VEE also interacts with other programming languages using industry-standard interfaces such as ActiveX.

Specifications

Minimum system requirements for Agilent VEE Pro 9.2 and Agilent VEE Express 9.2

Software requirements

- Microsoft Windows XP SP3 (or higher); Microsoft Windows 7 (Professional, Ultimate Enterprise) or higher; Microsoft Windows Vista SP1 (Business, Ultimate, Enterprise) or higher. Please note that 64-bit Windows 7 support is 32-bit application running on WOW 64 (Windows-on Windows) emulator
- Microsoft Internet Explorer 6.0 or higher
- Microsoft Office 2003 and 2007 (if using office products with Agilent VEE Pro or Agilent VEE Express)
- Agilent IO Libraries Suite 15.1 or higher (if communicating with instruments using Agilent VEE)
- Microsoft .NET Framework 3.5

PC hardware requirements

- 450 MHz Pentium® II or higher processor for Windows XP, or 1 GHz or higher for Windows Vista and Windows 7
- 128 MB RAM or higher for Windows XP, or 1 GB RAM or higher for Windows Vista and Windows 7
- 470 MB hard disk free space for Agilent VEE Pro, or 125 MB for Agilent VEE Express
- CD-ROM drive (if installing from CD)
- Super VGA (800 x 600) display or higher resolution monitor with 256 colors or more for Windows XP
- Support for DirectX 9 graphics with 128 MB graphics memory recommended (Super VGA graphics is supported) for Windows Vista and Windows 7
- PC keyboard and 2-button mouse
- Required connectivity options for instrumentation:
 - Agilent 82357B USB/GPIB interface
 - Agilent 82350B PCI-GPIB interface
 - Agilent 82351A PCIe/GPIB interface
 - Agilent E5810A LAN/GPIB gateway
 - Agilent E5805A USB/4-port RS-232 interface
 - Agilent E5813A networked 4-port USB hub
 - USB connectivity to instruments supporting the TMC protocol
 - Standard RS-232
 - LAN connectivity to instruments supporting the VXI-11 protocol

Ordering Information

W4000B-PRO Agilent VEE Pro 9.2 Software

W4000B-EXP Agilent VEE Express 9.2 Software

W4000B-STU Agilent VEE Pro 9.2 Student Software (for students only)

W4000B-ED1 Agilent VEE Pro Education 9.2 (for education customers only)

W4000B-UP85 upgrade from Agilent VEE Pro 8.5 to Agilent VEE Pro 9.2

W4000B-UP80 upgrade from Agilent VEE Pro 8.0 to Agilent VEE Pro 9.2

W4000B-UP75 upgrade from Agilent VEE Pro 7.5 and below to Agilent VEE Pro 9.2

W4000B-UPEXP upgrade from Agilent VEE Express 9.2 to Agilent VEE Pro 9.2

W4000B-UPEXP85 upgrade from Agilent VEE Express 8.5 to Agilent VEE Express 9.2

W4000B-EXPUP85 upgrade from Agilent VEE Express 8.5 to Agilent VEE Pro 9.2

W4000B-UPED Agilent VEE Education 9.2 10 license option – includes software entitlement certificate to add on 10 licenses to VEE Education 9.2 (W4000B-ED1)

W4000B-0B0 no documentation/education package – includes software entitlement certificate only/basic education package only (default for W4000B-STU and W4000B-UPED only)

Web Link

www.agilent.com/find/vee



Modular Products and Systems

Overview	252
Modules Selection Guide	254

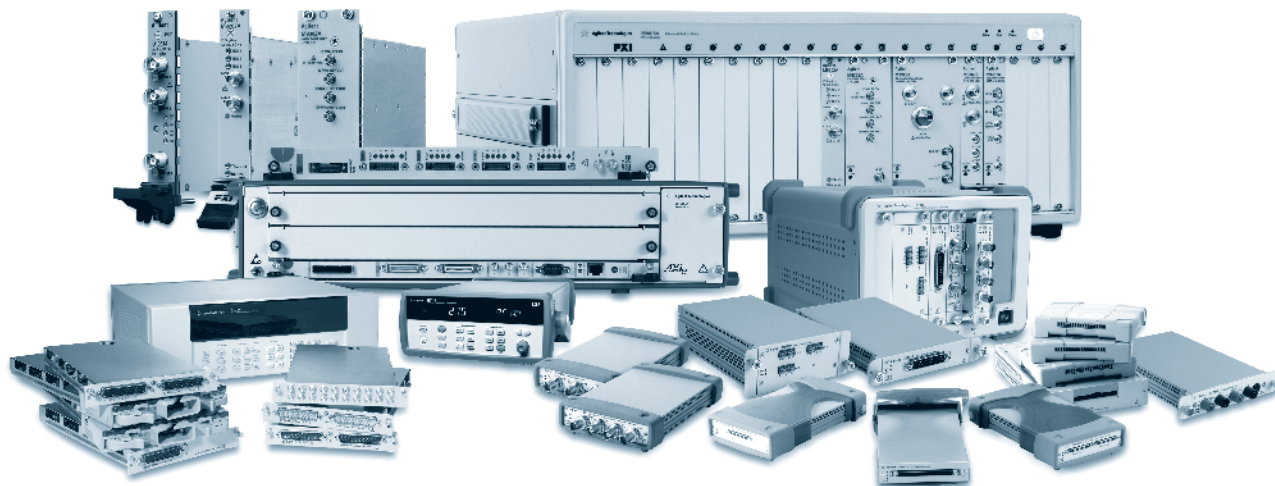

For data acquisition or automated test applications, Agilent’s modular instrumentation is an extension of our measurement expertise into modular form factors. This approach helps you build flexible test solutions that meet essential requirements – speed, flexibility, footprint, cost – across multiple domains with DC, analog, digital, RF, microwave and lightwave technologies. Ultimately, we can help you control ongoing cost of ownership through the ability to easily reconfigure solutions to match the evolution of your end products.

When to Consider Agilent Modular Products

A single form factor is rarely the right answer for every test scenario. That’s why Agilent provides a portfolio of modular devices to fit your diverse needs: from cost-sensitive test requirements to high-performance applications that need increased signal density and high-speed switching.

Agilent’s modular instrumentation leverages a variety of existing open standards:

- The VXI, PXI and AXIe standard architectures all define modular platforms for general purpose modular instrumentation
- The PXI standard, defined in the late 1990s, is a broadly adopted standard
- AXIe is a new open standard based on ATCA, PXI, LXI and IVI. It also complements LXI and PXI equipment. AXIe provides high performance per rack inch and includes features such as timing, triggering, and module-to-module data movement. Because it includes PCIe and LAN interfaces, AXIe instruments can act like virtual PXI or LXI instruments

With all of these capabilities, our modular instrumentation facilitates easy integration with traditional instrumentation.

We also offer a variety of compact modular instruments and a range of modules based on computer standards:

- For handheld and extremely cost sensitive applications, our family of USB-based modular instruments simplifies electronic functional test, troubleshooting, and data

logging and measurement. These devices offer the flexibility of standalone or modular operation for easy, affordable measurements and analysis

- For data-logging and data-monitoring applications in the lab or in the field, the Agilent 34972A data acquisition switch unit consists of a three-slot mainframe with a built-in 6½-digit DMM and eight different switch and control modules. With its built-in LAN and USB interfaces, you can easily connect to a PC or laptop without purchasing I/O cards or interface converters
- The 34980A multifunction switch/measure unit is a compact, economical, one-box solution for medium- and high-density switch/measure applications in design verification, automated test and data acquisition. It offers broad functionality that fits your budget without sacrificing accuracy
- For research, advanced-experimental and application-specific systems, Agilent solutions based on PCI, PCIe or cPCI provide exceptional speed, data fidelity and deep memory
- Our instruments are used in two major areas that require high-speed measurements: real-time applications and single-shot or event-based applications. We provide the extreme speed and precision needed for system monitoring and control, and for capturing data from the interactions and events within the system under test
- In these form factors, Agilent has implemented a variety of innovative techniques that ensure complete and detailed data capture: trigger delay, data streaming and multi-channel synchronization

Open Platform for Software Development

To help accelerate system development, every Agilent module includes a comprehensive portfolio of instrument drivers, documentation, examples, and software tools to help you quickly develop test systems with your software platform of choice. This includes development environments such as C/C++,

C# or Visual Basic from Microsoft; the LabVIEW and LabWindows/CVI software platforms from National Instruments; and MATLAB from The MathWorks.

For modules of the same family such as digitizers, the flexibility of the driver means that, with minimum software adjustments, any digitizer can be swapped out, replaced, or upgraded with the latest high-speed digitizer. Instrument drivers also provide context-sensitive help – Microsoft IntelliSense and LabVIEW hover-help – as well as complete documentation and examples so you can get started quickly and complete complex tasks.

You can use the Agilent IO libraries suite to display all of the modules in your system, whether they are PXI, PXIe, AXIe or cPCI. You can quickly view information about the installed software or start a module’s soft front panel. The Agilent soft front panel is a graphical interface that lets you quickly verify connectivity to a module and explore its functionality. When you get started programming the modules, you can use the IO monitor to trace all modular instrument driver calls to simplify system characterization and debug.

.NET Support

All Agilent modular instruments come with IVI-COM drivers that work directly in .NET environments such as C# and Visual Basic. We provide .NET assemblies with a complete set of properties and methods arranged in a hierarchy that makes it easy to locate the functions you need. Agilent drivers also include examples to help get you started easily.

Agilent is an enthusiastic supporter of the new IVI .NET standards, which were chaired by Agilent. As these standards are deployed, Agilent will extend its modular software to also provide IVI .NET drivers. IVI .NET drivers will differ from the current solution because they add C# source code and use native .NET classes directly.

Integration with Measurement Applications

Our modular instruments are integrated with Agilent measurement applications, many of which can uncover design problems and provide superior measurement insight in

various domains such as RF, microwave and digital. For example, in RF/wireless communications, you can use the Agilent 89600 vector signal analysis (VSA) software to characterize complex, time-varying signals with detailed and simultaneous spectrum, modulation and time waveform analysis.

Agilent PXI Instrumentation

The open PXI standard, defined in the late 1990s for general-purpose modular instrumentation, has seen rapid adoption in measurement and automation applications that require a compact form factor and modular channel expandability. As a result, PXI is being used in aerospace, military, automotive, digital, and wireless industries and domains.

In this form factor, Agilent lets you benefit from a large portfolio of chassis and modules integrated with world-class software applications to get trusted measurement results. One example is the industry's first single-vendor microwave analyzer in the PXI form factor. When combined with the 89601A VSA software, this analyzer – with its wide instantaneous bandwidth – provides a complete microwave VSA solution, enabling analysis of communications, radar, and avionics signals up to 26 GHz.

Oftentimes, designers of wideband systems require complex signal generation. Our PXI-based modular arbitrary waveform generators enable generation of real-world, real-time signals for precise simulation of target radars.

The Agilent PXI lineup also includes digitizers, digital multimeters (DMMs), V/Is, and a broad range of multiplexers, matrices and general-purpose switching products. Collectively, these can be used to match core needs in areas such as aerospace, defense, communications, mechatronics and research through large channel count and high throughput for high-speed measurements.

Agilent VXI Instrumentation

VXI bus is an established standard with many years of success. With Agilent's industry-standard VXI measurement instruments, you can quickly develop systems and leverage from a large portfolio of full-featured, instrument-quality modules.

Agilent's open industry software and I/O standards take the hassle out of creating test

code and lower the true cost of test. Our world-class measurement expertise and support can deliver accurate results in a hurry.

Agilent AXIe Instrumentation

This new standard is designed for high-performance instrumentation. Its hallmarks are high power and rack space efficiency.

- AXIe provides tremendous scalability and excellent rack-space efficiency. To enhance flexibility, a chassis can have one to 14 slots arranged in vertical or horizontal configurations. To support large channel counts, multiple chassis can be connected synchronously

Agilent PXI Chassis

The M9018A chassis delivers the ultimate flexibility, compatibility, and performance. With 16 PXIe hybrid slots, it allows the system designer to mix and match the number and location of PXIe and hybrid PXIe-compatible modules. The advanced PCIe switch fabric can operate up to Gen 2 speeds and can be configured for optimal performance with any PXIe controller. The innovative cooling design allows the chassis to fit in 4U of rack space in most cases. When combined with the latest 1U rack-mounted computer, you can build a powerful system using only 5U of rack space.

Agilent M9018A 18-Slot PXIe Chassis

- 16 hybrid slots: eases system integration with flexibility and compatibility
- Gen 2 speeds as well as four x8 and 12 x4 links to module slots: large data rate supports high-performance applications
- Advanced PCIe switching: provides configuration flexibility
- Innovative cooling design: saves rack space and lowers maintenance cost
- 1100W power supply: provides power to spare for application requirements

Connector compatibility

- cPCI (J1 only), PXIe, PXI-104

Hardware

- Size: 4U
- Number of slots: 18 total, 16 hybrid compatible
- Power supply:
 - 1100 watts total available
 - 30 W/slot cooling capacity
- Data bandwidth (max):
 - 4 GB/s slot-to-slot
 - 8 GB/s from user slot to system slot

Software

- Operating systems:
 - Microsoft Windows XP
 - Microsoft Windows Vista (32/64-bit)
 - Microsoft Windows 7 (32/64-bit)
- Supported software interfaces: IVI-COM, IVI-C, LabVIEW
- Supported application development environments (ADE): LabVIEW, LabWindows/CVI, MATLAB, VEE, Visual Basic, VisualStudio.NET (C/C++, C#, VB.NET)

Agilent AXI Chassis

The M9502A and M9505A AXIe chassis are fully compatible with the AXIe 1.0 specification. They provide 2 or 5 slots for AXIe instrument modules, and have an embedded system module that does not take up an instrument slot. The embedded system module provides Gigabit LAN and Gen 2 x8 PCIe interfaces for connecting the chassis to an external controller. To minimize rack space, the instrument module slots are arranged horizontally. In addition, the chassis are designed to be easily maintained, as both the power supply and fan tray can be removed while the chassis remains in the rack.

Agilent M9502A and M9505A AXIe Chassis

- Compact size: M9502A 2-slot chassis is ideal for transportable applications, while M9505A 5-slot saves rack space
- Gen 2 x4 links to module slots and 62 local bus pairs: enables high-performance applications
- Embedded AXIe system module: system module does not take up a slot, resulting in a smaller chassis
- High cooling capacity: provides cooling for high-performance modules

Connector compatibility

- AXIe 1.0

Hardware

- Size: 2U/4U
- Number of user module slots: 2/5
- Power supply: 650/1200 Watts
- Cooling: 200 Watts/slot
- Data bandwidth (max):
 - 2 GB/s user slot-to-system slot
 - 4 GB/s system slot-to-host
- Local bus pairs: 62 pairs between adjacent slots

Software

- Operating systems:
 - Microsoft Windows XP
 - Microsoft Windows Vista (32/64-bit)
 - Microsoft Windows 7 (32/64-bit)
- Supported software interfaces: IVI-COM, IVI-C, LabVIEW
- Supported application development environments (ADE): LabVIEW, LabWindows/CVI, MATLAB, VEE, Visual Basic, VisualStudio.NET (C/C++, C#, VB.NET)

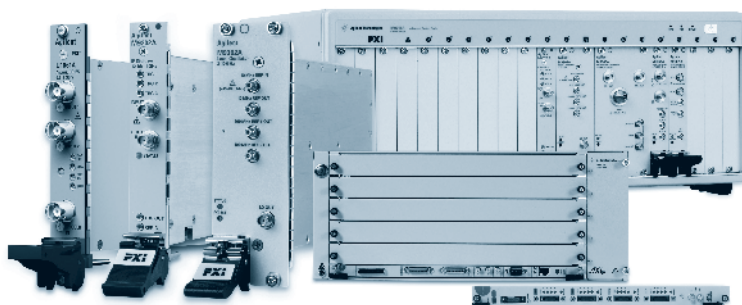

Web Link

www.agilent.com/find/modular

Digitizing Scopes and IF Digitizers

		Type # of slots	Resolution	Number of channels	Max. sample rate	Bandwidth	Memory depth	On-board processing	Page
M9210A	Digitizing scope	PXI-H 1 slot	10-bit	2	2 to 4 GS/s	1.4 GHz	512 MS	N/A	162
N2100B	10.3125 Gb/s digital communication analyzer	PXI-H 4 slots	12-bit	1 optical, 1 electrical	160 MS/s	12 GHz (electrical), 7.5 GHz (optical, unfiltered)	1 MS	N/A	126
M9202A	Digitizer	PXIe 1 slot	12-bit	1	2 GS/s	1 GHz	256 MS	DDC, Virtex-6 FPGA	77
M9211A	Digitizer	PXI-H 1 slot	10-bit	1	4 GS/s	3 GHz	512 MS	N/A	162

Function and Arbitrary Waveform Generators

		Type # of slots	Resolution	Number of channels	Bandwidth per channel	Modulated bandwidth	Sampling rate	Memory depth	Page
M9330A	Arbitrary waveform generator	PXI-H 4 slots	15-bit	2	500 MHz	1 GHz	1.25 GS/s	16 MS	209
M9331A	Arbitrary waveform generator	PXI-H 4 slots	10-bit	2	500 MHz	1 GHz	1.25 GS/s	16 MS	212

Digital Multimeters

		Type # of slots	Resolution	DC accuracy	Max reading speed	Floating isolation	Advanced triggering	Additional functions	Page
M9182A	6½ digit DMM	PXI-H, 1-slot	6.5 digit	30 ppm	4,500 rdg/s	300 Vrms	✓	°C, °F	N/A
M9183A	6½ digit enhanced DMM	PXI-H, 1-slot	6.5 digit	30 ppm	20,000 rdg/s	300 Vrms	✓✓	°C, °F, Capacitance	N/A

Pattern Generator

		Type # of slots	Bit rate range	PRBS patterns	Data patterns	Output voltage range	Outputs	Clock input voltage range	Page
N2102B	Pattern generator	PXI-H 2 slots	622 Mb/s to 10.3125 Gb/s	2 ⁿ -1, n = 7, 9, 11, 15, 23, 31	K28.5, K28.7, CRPAT, user-loadable 2 kbits	250 mV to 1 V pp	1 x differential ports	500 mV to 1 V pp	126

Digital IO

		Type # of slots	Channels	Inputs	Outputs	Speed	Memory	Connectors	Page
M9187A	32 channel digital IO	PXI 1 slot	32 inputs 32 outputs	Up to 50 V	Source 0.4 A sink 0.5 A	1.3 ms all channels	No	78D connector block or cable	N/A

Spectrum and Signal Analyzers

		Type # of slots	Frequency range	Phase noise (20 kHz offset)	DANL at 1 GHz	3rd order intercept (TOI) at 1 GHz	Analysis bandwidth	Software applications	Page
M9392A	Microwave vector signal analyzer	PXI PXIe 1 slot 7 slots	50 MHz to 26.5 GHz	-118 dBc/Hz (at 20 GHz)	-160 dBm/Hz		250 MHz	89600 VSA	75
M9302A	Local oscillator	PXI 2 slots	3 GHz to 10 GHz	-120 dBc/Hz	N/A	N/A	N/A	N/A	76
M9351A	Downconverter	PXI 1 slot	50 MHz to 2.9 GHz	N/A	N/A	-10 dBm (Two, -40 dB tones, 1 MHz apart)	40 MHz	N/A	76
M9360A	Attenuator/preselector	PXI 3 slots	100 KHz to 26.5 GHz	N/A	N/A	N/A	40 MHz min. (3 dB BW, YTF*)	N/A	77
M9361A	Downconverter	PXI 1 slot	2.75 to 26.5 GHz	N/A	N/A	-10 dBm (Two, -40 dB tones, 1 MHz apart)	250 MHz	N/A	75
M9202A	IF digitizer	PXIe 1 slot	2 GS/s (sampling rate)	N/A	-144 dBm/Hz (noise density) (preliminary)	N/A	30 MHz to 1 GHz	N/A	77

Signal Conditioning Modules

		Type # of slots	Frequency range	Bandwidth	Noise figure	TOI	IF center frequency	Min/max power	Page
M9351A	Downconverter	PXI 1 slot	50 MHz to 2.9 GHz	40 MHz	10 dB max	-10 dBm (Two, -40 dB tones, 1 MHz apart)	500 MHz	-160 dBm/ -40 dBm	76
M9361A	Downconverter	PXI 1 slot	2.75 to 26.5 GHz	250 MHz	30 dB at 26.5 GHz	-10 dBm (Two, -40 dB tones, 1 MHz apart)	500 MHz	-40 dBm (max)	75
M9360A	Attenuator/ preselector	PXI 3 slots	100 kHz to 26.5 GHz	40 to 120 MHz (3 dB BW, YTF*)	N/A	N/A	N/A	+30 dBm (max)	77

RF Signal Generators (Signal Source)

		Type # of slots	Frequency range	Output power	Phase noise (20 kHz offset)	Switching speed	Output power accuracy	Software applications	Page
M9302A	Local oscillator	PXI 2 slots	3 to 10 GHz	16 dBm	-118 dBc/Hz at 20 GHz	1 ms	±2 dB	N/A	76
N2099B	RF synthesizer and clock source for N2102B, N2101B	PXI-H 2 slots	Optional 5.25 ± 1 GHz or 10.5 ± 1 GHz	Min +8 dBm (4, 5, 6 GHz); min +6 dBm (9, 10, 11 GHz)	500 MHz	100 ms	±3 dB variation over temperature, frequency	N/A	N/A

V/I Source

		Type # of slots	Channels/ crosspoints	Scan channel/ second	Max voltage	Max current	Frequency range	Page
M9186A	V/I source	PXI 2 slots	1	N/A	100 V at 20 mA 16 V at 200 mA	200 mA	N/A	N/A

General Purpose Switches

		Type # of slots	Channels	Switching speed (typical)	Max voltage	Current switch & carry	Relay type	Connectors	Page
M9130A	SPDT switch	PXI 1 slot	26 Form C	3 ms	Contact Agilent	2 A/2 A	Electro-mechanical	78D connector block or cable	268
M9131A	SPDT switch	PXI 1 slot	64 Form C	0.5 ms	100 V	1 A/1 A	Reed	200LFH connector block or cable	268
M9132A	SPST switch	PXI 1 slot	50 Form A	0.5 ms	100 V	1 A/1 A	Reed	200LFH connector block or cable	268
M9133A	SPST switch	PXI 1 slot	100 Form A	0.5 ms	100 V	1 A/1 A	Reed	200LFH connector block or cable	268
M9135A	SPST power relay	PXI 1 slot	20 Form A	10.5 ms	Contact Agilent	10 A/10 A	Electro-mechanical	20MSM connector block or cable	268

Multiplexers and Matrix Switches

		Type # of slots	Channels	Switching speed (typical)	Max voltage	Current switch and carry	Relay type	Connectors	Page
M9101A	High-density multiplexer	PXI 1 slot	64 channels, 2-wire	500 µs	100 V	0.5 A/1.0 A	Reed	200LFH connector block or cable	268
M9102A	High-density multiplexer	PXI 1 slot	128 channels, 1-wire	500 µs	100 V	0.5 A/1.0 A	Reed	200LFH connector block or cable	268
M9103A	High-density multiplexer	PXI 1 slot	99-channels, 2-wire	3 ms	100 V	1 A/1 A	Electro-mechanical	200LFH connector block or cable	268
M9120A	Matrix switch	PXI 1 slot	4 x 32, 2-wire	3 ms	125 V	2 A/2 A	Electro-mechanical	78D connector block or cable	268
M9121A	High-density matrix switch	PXI 1 slot	4 x 64, 2-wire	1 ms	100 V	0.5 A/0.5 A	Reed	200LFH connector block or cable	268
M9122A	Matrix switch	PXI 1 slot	8 x 32, 1-wire	3 ms	Contact Agilent	2 A/2 A	Electro-mechanical	50D connector block or cable	268

* YTF means YIG-tuned filter

Microwave Switches

		Type # of slots	Frequency range	Insertion loss	Isolation	VSWR	Impedance	Connectors	Page
M9155C	Dual SPDT switch	PXI-H 1 slot	DC to 26.5 GHz	0.25 + 0.027 x f (in GHz) DC: 0.25 dB 8 GHz: 0.47 dB 12.4 GHz: 0.58 dB 18 GHz: 0.74 dB 26.5 GHz: 0.96 dB	DC: 110 dB 8 GHz: 92 dB 12.4 GHz: 82 dB 18 GHz: 70 dB 26.5 GHz: 50 dB	DC to 4 GHz: 1.25 4 to 18 GHz: 1.45 18 to 26.5 GHz: 1.70	50 Ω	SMA (f)	324
M9156C	Dual transfer switch	PXI-H 2 slots	DC to 26.5 GHz	0.2 dB + 0.025 x f (in GHz) DC: 0.20 dB 8 GHz: 0.40 dB 12.4 GHz: 0.51 dB 18 GHz: 0.65 dB 26.5 GHz: 0.86 dB	DC: 110 dB 8 GHz: 94 dB 12.4 GHz: 85 dB 18 GHz: 74 dB 26.5 GHz: 57 dB	DC to 2 GHz: 1.10 2 to 4 GHz: 1.15 4 to 12.4 GHz: 1.25 12.4 to 20 GHz: 1.40 20 to 26.5 GHz: 1.65	50 Ω	SMA (f)	324
M9157C	Single SP6T switch	PXI-H 3 slots	DC to 26.5 GHz	0.3 dB + 0.015 x f (in GHz) DC: 0.30 dB 8 GHz: 0.42 dB 12.4 GHz: 0.49 dB 18 GHz: 0.57 dB 26.5 GHz: 0.70 dB	DC to 12 GHz: 90 dB 12 to 15 GHz: 70 dB 15 to 20 GHz: 65 dB 20 to 26.5 GHz: 60 dB	DC to 4 GHz: 1.20 4 to 12.4 GHz: 1.35 12.4 to 20 GHz: 1.45 20 to 26.5 GHz: 1.70	50 Ω	SMA (f)	324

RF Switches

		Type # of slots	Frequency range	Insertion loss (typical)	Isolation (typical)	VSWR (typical)	Impedance	Connectors	Page
M9128A	8 x 12 RF matrix switch	PXI 1 slot	300 Mhz	3 dB at 300 MHz	80 dB at 300 MHz	1:2.1 at 300 MHz	50 Ω	SMB connectors	268
M9146A	Dual 1 x 4 RF multiplexer	PXI 1 slot	3 GHz	1 dB at 3 GHz	45 dB at 3 GHz	1.3:1 at 3 GHz	50 Ω, off channel termination	SMB connectors	268
M9147A	Quad 1 x 4 RF multiplexer	PXI 1 slot	3 GHz	1.3 dB at 3 GHz	35 dB at 3 GHz	1.5:1 at 3 GHz	50 Ω	SMB connectors	268
M9148A	1 x 8 RF multiplexer	PXI 1 slot	3 GHz	1.2 dB at 3 GHz	38 dB at 3 GHz	1.2:1 at 3 GHz	50 Ω	SMB connectors	268
M9149A	1 x 16 high density RF multiplexer	PXI 1 slot	3 GHz	1.3 dB at 3 GHz	38 dB at 3 GHz	1.4:1 at 3 GHz	50 Ω	SMB connectors	268
M9150A	Dual 1 x 4 RF multiplexer	PXI 1 slot	3 GHz	1.6 dB at 3 GHz	40 dB at 3 GHz	1.6:1 at 3 GHz	75 Ω	SMB connectors	268
M9151A	Quad 1 x 4 RF multiplexer	PXI 1 slot	3 GHz	1.6 dB at 3 GHz	40 dB at 3 GHz	1.6:1 at 3 GHz	75 Ω	SMB connectors	268
M9152A	1 x 8 RF multiplexer	PXI 1 slot	3 GHz	2.1 dB at 3 GHz	39 dB at 3 GHz	1.5:1 at 3 GHz	75 Ω	SMB connectors	268
M9153A	1 x 16 RF multiplexer	PXI 1 slot	3 GHz	1.9 dB at 3 GHz	38 dB at 3 GHz	1.6:1 at 3 GHz	75 Ω	SMB connectors	268

Bit Error Rate Testers (BERTS)

		Type # of slots	Bit rate	PRBS patterns	Data patterns	Output voltage range	Outputs	External clock input	Page
N2101B	Bit error ratio tester	PXI-H 3 slots	155 Mb/s to 10.3125 Gb/s	2 ⁿ - 1, n = 7, 9, 11, 15, 23, 31	K28.5, K28.7, CRPAT, user-loadable 2 kbits	250 mV to 1 V pp	1 x differential ports	500 MHz to 10.7 GHz	119

Chassis and Controllers

		Height	Type # of slots	Number of slots	Maximum data bandwidth	System slot interface	Power supply	Power per slot	Page
M9018A	PXIe gen 2.0 chassis	4U	PXIe 3U 18 slots	1 system 1 timing 16 hybrid	Module-to-module: 4 GB/s System-to-backplane: 8 GB/s	Configurable: 1 x 8, 2 x 8, 1 x 4, or 4 x 4	1100 W	System 140 W PXIe 30 W	253

PXI I/O and Computer Modules

		Type # of slots	Processor	RAM (min/max)	HDD	Maximum data bandwidth	Cable interface	System slot interface	Page
M9021A	PXIe system interface	3U PXIe 1 slot	N/A	N/A	N/A	4 GB/s	x 8 gen PCIe	x 8 gen 2 PCIe	N/A

External PC Cards

		Type # of slots	Maximum data bandwidth	Cable interface	PC host interface	Page
M9045A	PCIe ExpressCard adaptor: gen 1	ExpressCard 34 1 slot	250 MB/s	x 4 gen 1 PCIe	x 1 gen 1 PCIe	N/A
M9047A	PCIe desktop adaptor: gen 2	PCIe x 8 or x 16 1 slot	4 GB/s	x 8 gen 2 PCIe	x 8 gen 2 PCIe	N/A

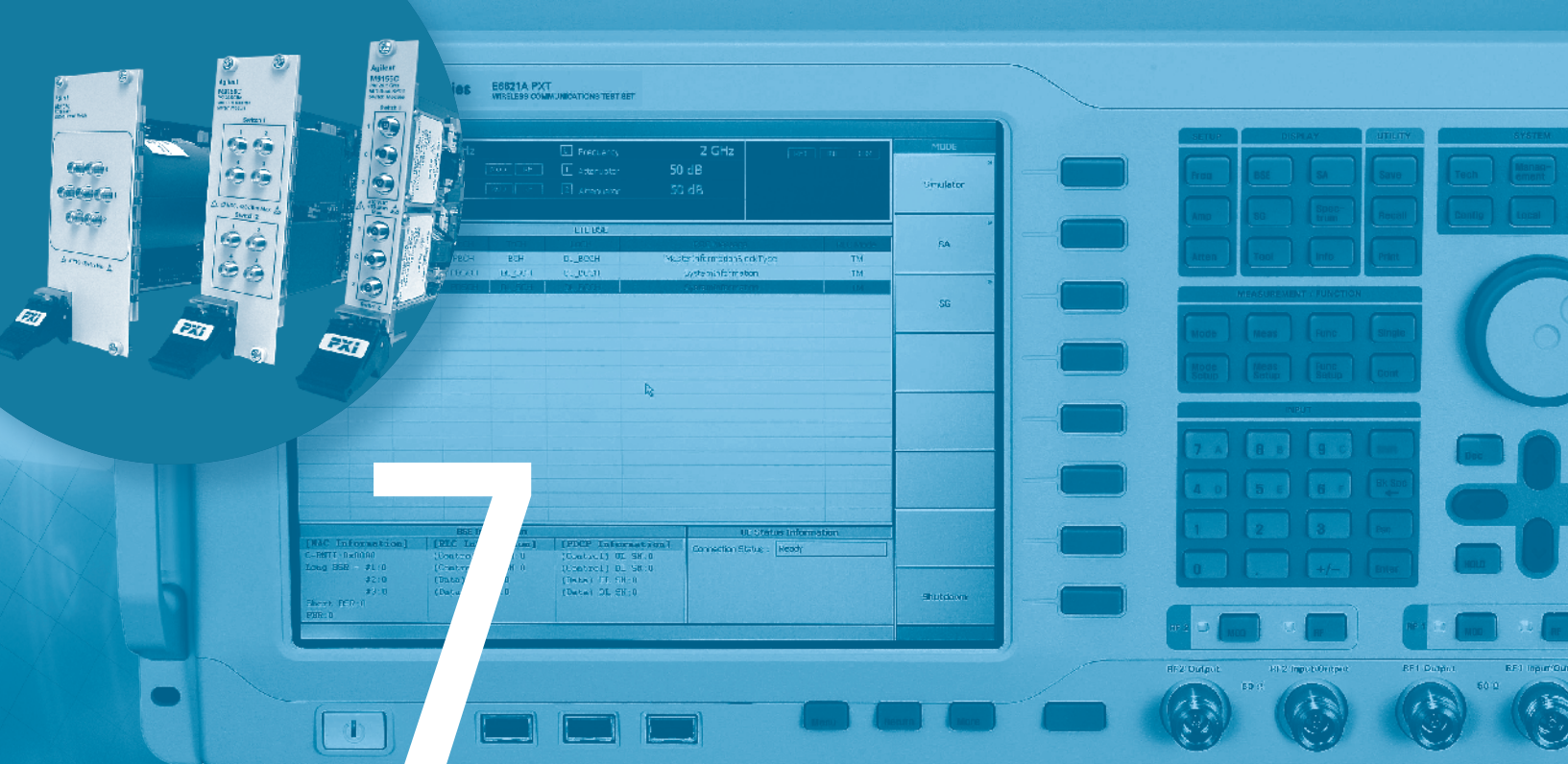

Additional Test & Measurement Products

Data Acquisition Hardware & System Switching	258
Wireless Device Test Sets & Wireless Solutions	269
Automated Test Systems and Application – Specific Test Systems	291
Photonic Test & Measurement	295
Atomic Force Microscopes, Nanoindenters	311
GPIO, USB, and Instrument Control Products	319
RF and Microwave Test Accessories	323

34970A
34972A
34901A
34902A
34903A
34904A
34905A
34906A
34907A
34908A

- **3-slot mainframe with built-in 6½ digit DMM (22-bit) and choose from 8 plug-in modules**
- **Measures 11 different input signals including temperature with thermocouples, RTDs and thermistors; DCV, ACV, DCI, ACI, 2 or 4 wire Ω; frequency and period**
- **34972A accepts all 34970A switch and control plug-in modules, and is backward compatible with the 34970A SCPI command set**
- **LAN, USB 2.0, GPIB, and RS-232 IO options**
- **USB memory port for data storage or transfer (34972A)**
- **Graphical Web interface for easy set up and control (34972A)**
- **Includes BenchLink data logger software for easy data collection and analysis, optional BenchLink Data Logger Pro for more advanced applications**
- **LXI C compliant (34972A)**

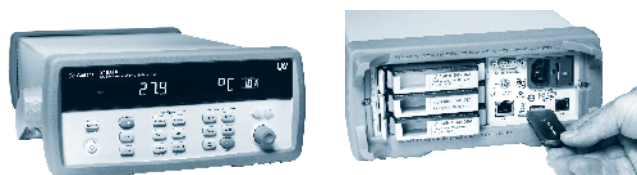

34972A low-cost data acquisition switching unit

34972A Data Acquisition / Switch Unit

The Agilent 34972A is an easy to use, low-cost data acquisition and switching mainframe ideal for data logging, data acquisition, and general-purpose switching and control applications. It consists of a half-rack, 3-slot mainframe with a built-in 6½ digit digital multimeter and 8 different switch and control modules. This product features built-in LAN and USB interfaces so you can easily connect to a PC or laptop without needing to purchase additional IO cards or converter interfaces. The intuitive graphical Web interface offers easy remote control over the network with per channel measurement configuration, data logging and data monitoring. If GPIB or RS-232 interfaces are desired, the 34970A offers the IO connectivity with the same 34972A functionality.

Included BenchLink Software Simplifies your Data Gathering

If you want PC-based data logging capabilities, but don't want to spend hours programming, BenchLink data logger is the answer. Use it to set up your test, acquire and archive measurement data, and perform real-time display and analysis of the incoming measurements. The BenchLink data logger software comes with the 34972A and provides a familiar Microsoft Windows interface for test configuration and real-time data display and analysis. Setup and make measurements with point-and-click ease, export data or use the built-in graphs to log your results. Download free BenchLink data logger software. Or, use the 34830A BenchLink Data Logger Pro that adds advanced data logging and decision making for your more complex data acquisition tasks.

Convenient Data Storage with USB Flash Drive

The 34972A features a built-in USB memory port so that you can use a USB flash drive to upload BenchLink data logger configurations into the 34972A and collect data without being connected to a PC. Data can be logged directly to the USB flash drive, extending your instrument's memory, or copied from internal memory for transfer to a computer in another location. Simply connect the USB stick to your PC to easily import data into a spreadsheet or other applications for analysis.

Module Overview

Up to three modules, in any combination, can be inserted into a single mainframe. The 34970A/34972A's internal DMM connections are accessible only through the 34901A, 34902A, and 34908A multiplexers. Choose from eight plug-in modules which feature on-board screw terminals and relay closure count. These features make it easy for you to create a compact data logger, full-featured data acquisition system or low-cost switching unit that is easy to connect, configure and use on the

bench, on a network or in field applications. The 34972A and 34970A both use the same plug-in modules. With a simple address change the 34972A is easily integrated into an existing 34970A test with no wiring or hardware changes.

Modules for 34970A/34972A data acquisition control units

Product	Description	Speed (Ch/Sec)	Max voltage	Max current	Comments
34901A	20-Ch multiplexer (2/4-wire)	60	300 V	1 A	2 current channels (22 ch total); built-in cold junction reference; connect to internal DMM
34902A	16-ch. multiplexer (2/4-wire)	250	300 V	50 mA	Built-in cold junction reference; reed relays multiplex inputs to internal
34903A	20-ch. actuator/GP switch	120	300 V	1 A	Form C (SPDT) switches; no connection to internal DMM
34904A	4x8 matrix	120	300 V	1 A	2-wire, full crosspoint; no connection to internal DMM
34905A	2-GHz dual 1:4 RF mux, 50 ohm	60	42 V	0.7 A	1-GHz through provided BNC-to-SMB adapter cables; no connection to internal DMM
34906A	2-GHz dual 1:4 RF mux, 75 ohm	60	42 V	0.7 A	1-GHz through provided BNC-to-SMB adapter cables; no connection to internal DMM
34907A	Two 8-bit digital I/O ports	—	42 V	400 mA	Open drain
	26-bit, 100-kHz event counter	—	42 V		Gated, selectable input threshold
	Two 16-bit analog outputs	—	±12 V	10 mA	Earth referenced, calibrated. No connection to internal DMM
34908A	40-ch. single-ended multiplexer	60	300 V	1 A	Common low, no 4-wire meas. Built-in cold junction reference; connects to internal DMM

Ordering Information

Mainframes

- 34970A** data acquisition/switch unit with RS-232 and GPIB
- 34972A** data acquisition/switch unit with LAN and USB
- 001** delete internal DMM

Modules are purchased separately and are required to operate.

Modules

- 34901A** 20-channel armature multiplexer
- 34902A** 16-channel reed multiplexer
- 34903A** 20-channel actuator/general purpose switch
- 34904A** 4 x 8 two-wire matrix switch
- 34905A** Dual 4-channel RF multiplexer, 50 Ohms
- 34906A** Dual 4-channel RF multiplexer, 75 Ohms
- 34907A** multifunction module
- 34908A** 40-channel single-ended multiplexer

Accessories

- 34830A** BenchLink Data Logger Pro software optional software package that adds limit checking and decision making for more complex applications

Specifications

34970A/34972A abbreviated accuracy specifications

± (% of reading + % of range)

Includes measurement error, switching error, and transducer conversion error

Function	Range	Frequency, etc.	1 Year 23 °C ± 5 °C
DC voltage	100.0000 mV		0.0050 + 0.0040
	1.000000 V		0.0040 + 0.0007
	10.00000 V		0.0035 + 0.0005
	100.0000 V		0.0045 + 0.0006
	300.000 V		0.0045 + 0.0030
True RMS AC voltage	All ranges from 100.0000 mV to 100.0000 V	3 – 5 Hz	1.00 + 0.04
		5 – 10 Hz	0.35 + 0.04
		10 Hz – 20 kHz	0.06 + 0.04
		20 – 50 kHz	0.12 + 0.05
		50 – 100 kHz	0.60 + 0.08
	300.0000 V	100 – 300 kHz	4.00 + 0.50
		3 – 5 Hz	1.00 + 0.08
		5 – 10 Hz	0.35 + 0.08
		10 Hz – 20 kHz	0.06 + 0.08
		20 – 50 kHz	0.12 + 0.12
		50 – 100 kHz	0.60 + 0.20
100 – 300 kHz	4.00 + 1.25		
Resistance	100.0000 Ω	1 mA current source	0.0010 + 0.004
	1.000000 kΩ	1 mA	0.010 + 0.001
	10.00000 kΩ	100 μA	0.010 + 0.001
	100.0000 kΩ	10 μA	0.010 + 0.001
	1.000000 MΩ	5.0 μA	0.010 + 0.001
	10.00000 MΩ	500 nA	0.040 + 0.001
	100.0000 MΩ	500 nA 10 MΩ	0.800 + 0.010
Frequency and period	100 mV to 300 V	3 – 5 Hz	0.10
		5 – 10 Hz	0.05
		10 – 40 Hz	0.03
		40 Hz – 300 kHz	0.01
DC current (34901A only)	10.00000 mA	< 0.1 V burden	0.050 + 0.020
	100.0000 mA	< 0.6 V	0.050 + 0.005
	1.000000 A	< 2 V	0.100 + 0.010
True RMS AC current (34901A only)	10.00000 mA to 1.000000 A	3 – 5 Hz	1.00 + 0.04
		5 – 10 Hz	0.30 + 0.04
		10 – 5 kHz	0.10 + 0.04
	100.0000 mA	3 – 5 Hz	1.00 + 0.5
		5 – 10 Hz	0.30 + 0.5
		10 Hz – 5 kHz	0.10 + 0.5

Module abbreviated specifications

Module description	Type	Speed (ch/sec)	Voltage in (max)	Current in (max)	Thermal offset	Bandwidth	Comments
34901A 20 ch multiplexer +2 current channels	2-wire armature (4-wire selectable)	60	300 V	1 A	< 3 μV	10 MHz	w/ cold junction reference
34902A 16 ch multiplexer	2-wire reed (4-wire selectable)	250 ¹	300 V	50 mA	< 6 μV	10 MHz	w/ cold junction reference
34903A 20 ch actuator/GP switch	SPDT/form C	120	300 V	1 A	< 3 μV	10 MHz	—
34904A 4 x 8 matrix	2-wire armature	120	300 V	1 A	< 3 μV	10 MHz	Full cross point
34905A Dual 4 ch RF Mux 50 Ω	Common low (un-terminated)	60	42 V	0.7 A	< 6 μV	2 GHz	1 GHz bandwidth through BNC-to-SMB adapter cable
34906A Dual 4 ch RF Mux 75 Ω	Common low (un-terminated)	60	42 V	0.7 A	< 6 μV	2 GHz	1 GHz bandwidth through BNC-to-SMB adapter cable
34907A Multifunction module	Two 8-bit digital I/O ports	—	42 V	400 mA	—	—	Open drain
	26-bit event counter	—	42 V	—	—	100 KHz	Selectable input threshold
	Two 16-bit analog outputs	—	± 12 V	10 mA	—	DC	DC max 40 mA total out/frame
34908A 40 ch single-ended Mux	1-wire armature (common low)	60	300 V	1 A	< 3 μV	10 MHz	w/ cold junction reference No 4-wire measurements

¹ Up to 250 ch/sec to internal memory

Temperature	Type	1-year accuracy	Extended range 1-year accuracy
Thermocouple	B	1100 to 1820 °C	1.2 °C
	E	–150 to 1000 °C	1.0 °C
	J	–150 to 1200 °C	1.0 °C
	K	–100 to 1200 °C	1.0 °C
	N	–100 to 1300 °C	1.0 °C
	R	300 to 1760 °C	1.2 °C
	S	400 to 1760 °C	1.2 °C
T	–100 to 400 °C	1.0 °C	
RTD	R0 from 49 Ω to 2.1 kΩ	–200 to 600 °C	0.06 °C —
	Thermistor	2.2 k, 5 k, 10 k	–80 to 150 °C

34970A
34972A
34901A
34902A
34903A
34904A
34905A
34906A
34907A
34908A

Single channel reading rates to I/O or internal memory

Mainframe	34970A		34972A
	Into memory readings/sec	To GPIB or RS232 readings/sec	To LAN, USB or memory readings/sec
Single channel ASCII readings	500	440	500
Single channel while changing scale (eg MEAS dcV 10/MEAS dcV ¹)	25	25	25
Single channel while changing function (eg MEAS dcV/MEAS Ohms)	12	12	12

¹ Up to 250 ch/sec to internal memory

Web Link

www.agilent.com/find/34972A
www.agilent.com/find/34970A

34980A

- 8-slot mainframe, your choice of 21 different plug-in modules
- High-performance switching: up to 560 2-wire multiplexer channels or 4096 matrix cross-points in one mainframe
- Built-in DMM with 6½ digits (22 bits) of resolution
- Scan rates of up to 1000 channels/sec
- Standard LAN, USB 2.0, and GPIB connectivity to PC
- Includes BenchLink data logger software for easy data collection and analysis, optional BenchLink Data Logger Pro for more advanced applications
- LXI Class C compliant



34980A front and back panel

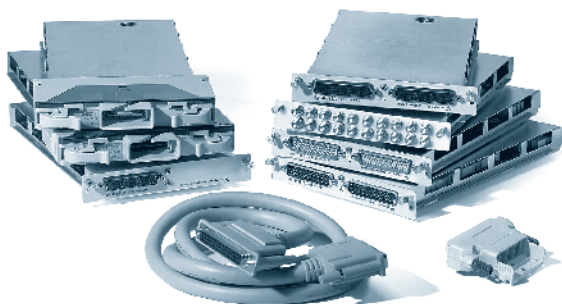

34980A modules, terminal blocks and cables

High-Performance Unit Provides Low-Cost Alternative to PXI and VXI Switch and Measurement Platforms

If you use automated test equipment for design validation or manufacturing, you now have a cost-effective alternative to PXI and VXI based test-system platforms. The 34980A multifunction switch/measure unit provides comparable functionality that is much easier to use than PXI and VXI and costs less. The 34980A helps you lower your cost of test and accelerate your test-system integration and development.

The 34980A handles your system switching needs up to 20 GHz and provides basic measurements and system control. It offers optional DMM measurements, counter/totalizer functionality, digital I/O with pattern capabilities, and analog outputs with basic waveforms – all in one low-cost, compact box. And with its standard connectors and software drivers, computer-standard I/O, and Web browser interface, the 34980A easily integrates into electronic functional test and data acquisition systems.

Flexible Switching, Measurements, and System Control

The 34980A accommodates up to 8 plug-in modules to give you the flexibility you need. Choose from 21 different modules to define your own configuration. You can buy what you need now and add to it or reconfigure it as your requirements change.

Whether you are measuring temperature, AC or DC voltage, resistance, frequency, current, or custom measurements, the 34980A offers the functionality you need in a single box. Switch in different measurements with high-performance signal switching – no external signal conditioning is required. Choose between different switch types and topologies with frequency ranges from DC to 20 GHz. The 34980A offers high-density multiplexers for scanning multiple channels, matrices for connecting multiple points at one time, and general purpose switches for simple control and high power needs.

The 34980A also offers flexible choices for system control. You can control external devices such as microwave switches, attenuators, solenoids, and power relays. Or use the digital inputs to sense limit-switch and digital-bus status.

Optimized for Test Systems

Your signals are switched to the right measurement device without compromising signal integrity. Switch your signals to the optional internal DMM and achieve optimal throughput on switch closure time.

The rugged instrument comes with a variety of system-ready features:

- Web browser interface shows settings at a glance and provides remote access and control
- Self-guiding front panel to configure, troubleshoot or view data
- Low EMI and efficient system cooling
- Heavy-duty cabling and connection options
- Rackmount options
- Relay counters help predict end-of-life
- In-rack calibration for reduced maintenance time
- DMM measurement accuracies include the switch for simple calculations

Make system connections easily and quickly with simple, reliable connection options:

- Built-in Ethernet, USB 2.0, and GPIB connectivity
- Standard IVI and LabVIEW software drivers
- Low-cost, standard 50- or 78-pin Dsub connectors and cables
- Detachable terminal blocks with strain relief
- Mass interconnect solutions

Easier signal routing with four 2-wire internal analog buses. You can route your measurements directly to the internal DMM, or you can connect to external instruments through the analog bus connector on the rear of the mainframe. And since you have four 2-wire buses, you can dedicate one bus for use with the internal DMM and use the other three buses for module extensions or additional signal routing between modules, reducing your wiring needs.

Measurements you can Trust

Get proven performance from Agilent instruments, with the resolution, repeatability, speed, and accuracy you've come to expect.

The 34980A offers built-in signal conditioning and modular flexibility. When you use it with the internal DMM, you can configure each channel independently for the measurements you choose. It includes a variety of features that give you confidence in your measurements:

- 6½ digits of resolution with .004% of accuracy with DC voltage measurements
- Alarms per channel – high limit, low limit, or both
- Math functions – use Mx+B for custom linear conversions and converting raw inputs
- Built-in thermocouple reference for temperature measurements (34921T)
- Time-stamped readings

The integrated DMM is mounted inside the mainframe and does not consume any of the eight user-available slots and gives you the flexibility to measure 11 types of inputs:

- Temperature with thermocouples, RTDs, or thermistors (with 34921A)
- DC and AC voltage
- 2- and 4-wire resistance
- Frequency and period
- DC and AC current



BenchLink Data Logger Software for Easy Data Collection and Analysis

The Agilent 34826A BenchLink data logger software provides a convenient way to collect and analyze your data from a windows-based application. The tab-based format makes it easy to set up and initiate scans. Simply identify the measurements you want to acquire, initiate the process, and see the data displayed real-time. You can specify individual channel setups, set alarms and perform statistical calculations to analyze the data points you want. Graph your data, save it to disk or export it to other applications for presentation and analysis.

Also get the high performance of the 34980A. Log data at speeds up to 900 ch/sec with the FET multiplexer, or take advantage of the high-density capabilities of the 34980A. Get PC-based data logging capability without spending hours programming.

Also available is the 34832A BenchLink Data Logger Pro software. This software adds limit checking and decision making for more complex applications. Simply identify the measurements you want to acquire, define your limits and actions to be preformed, and then initiate the process. Your data is then collected evaluated and acted on real-time.

Standard Interfaces Take the Hassle Out of Connecting to your PC

Standard Ethernet, USB and GPIB

Standard interfaces are included in every mainframe. Use one of the interfaces that is already available in your computer, or if you prefer, GPIB is still available.

Remote Access and Control

The built-in Web browser interface provides remote access and control of the instrument via a Java-enabled browser such as Internet Explorer. Using the Web interface, you can set up, troubleshoot, and maintain your system remotely.

- View and modify instrument setup
- Open, close, or monitor switches
- Send SCPI commands
- Define and execute switch sequences
- View error queue
- Get status reports on relay counts

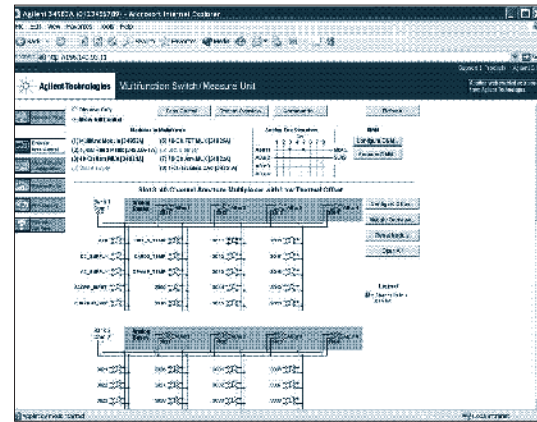

The Web interface makes it easy to set up, troubleshoot and maintain your system remotely

Works With your Choice of Software

You can save time and preserve your software and hardware investments. You can program directly with SCPI, use BenchLink data logger or IVI or LabVIEW software drivers that provide compatibility with the most popular development environments and tools.

Specifications and Ordering Information

The 34980A mainframe holds up to eight plug-in modules. Mix and match them to create a customized system to meet your switching and system control needs. You can easily add or replace modules as your needs change.

Mainframe	Comments
34980A Multi-function switch/measure mainframe	Holds up to 8 plug in modules and comes standard with a digital multimeter

34980A Modules

Low frequency switch modules	Max Volts	Switch current	Carry current	BW (MHz)	Scan ch/sec	Thermal offset	Comments
34921A 40-channel armature multiplexer w/ low thermal offset	±300 V	1 A	2 A	45 MHz	100	< 3 μV	Temperature reference 4 current channels Config as 2- or 4-wire
34922A 70-channel armature multiplexer	±300 V	1 A	2 A	25 MHz	100	< 3 μV	Config as 2- or 4-wire
34923A 40/80-channel reed multiplexer	±150 V	0.5 A	1.5 A	45 MHz	500	< 50 μV	Config as 1-, 2- or 4-wire
34924A 70-channel reed multiplexer	±150 V	0.5 A	1.5 A	25 MHz	500	< 50 μV	Config as 2- or 4-wire
34925A 40/80-channel optically isolated FET multiplexer	±80 V	0.05 A	0.02 A	1 MHz	1000	< 3 μV	Config as 1-, 2- or 4-wire
34931A Dual 4x8 armature matrix	±300 V	1 A	2 A	30 MHz	100	< 3 μV	Backplane expandable
34932A Dual 4x16 armature matrix	±300 V	1 A	2 A	30 MHz	100	< 3 μV	Backplane expandable
34933A Dual/quad 4x8 reed matrix	±150 V	0.5 A	1.5 A	30 MHz	500	< 50 μV	Backplane expandable Config as 1- or 2-wire
34934A Quad 4x32 reed matrix	±100 V	0.5 A	0.5 A	20 MHz	500	< 50 μV	Row expansion kit Config as 1- or 2-wire
34937A 28-channel Form C and 4-channel Form A	300 V 250 VAC	1 A 5 A	2 A	10 MHz	—	< 3 μV < 3 μV	— —
34938A 20-channel 5-amp Form A	250 VAC	5 A	8 A	1 MHz	—	< 3 μV	—
34939A 64-channel Form A	±100 V	1 A	2 A	10 MHz	—	< 3 μV	—

RF and microwave modules	Insertion loss	Isolation	Freq range	VSWR	Input impedance	Comments
34941A Quad 1x4 50 ohm 3 GHz RF multiplexer	0.6 dB	> 58 dB	3 GHz	< 1.25	50 Ω	@ 1 GHz
34942A Quad 1x4 75 ohm 1.5 GHz RF multiplexer	0.6 dB	> 60 dB	1.5 GHz	< 1.35	75 Ω	@ 1 GHz
34945A/ 34945EXT Microwave switch/attenuator driver	Can drive up to 64 external switch coils; 32 SPDT switches, 8 multipoint switches, 8 attenuators, or your own combination. Expand with additional 34945EXTs					
34946A Dual 1x2 SPDT terminated microwave switch	< 0.42 dB < 0.69 dB < 0.8 dB	> 85 dB > 67 dB < 60 dB	4 GHz or 20 GHz 26.5 GHz	< 1.15 < 1.30 < 1.6	50 Ω	@ 4 GHz @ 20 GHz @ 26.5 GHz
34947A Triple 1x2 SPDT unterminated microwave switch	< 0.42 dB < 0.69 dB < 0.8 dB	> 85 dB > 67 dB < 60 dB	4 GHz or 20 GHz 26.5 GHz	< 1.15 < 1.30 < 1.6	50 Ω	@ 4 GHz @ 20 GHz @ 26.5 GHz

System control modules	Description
34950A 64-bit digital I/O with memory and counter	Eight 8-bit digital I/O channels with programmable polarity, thresholds up to 5 V, with handshaking protocols and pattern memory. Two 10-MHz frequency counter and programmable clock output to 20 MHz
34951A 4-channel isolated D/A converter with waveform memory	Output DC voltage up to ±16 V or DC current up to ±20 mA. Output waveforms with a 200 kHz update rate and 16 bits of resolution. Use on-board memory to create point-to-point waveforms with more than 500,000 points
34952A Multifunction module with 32-bit DIO, 2-ch D/A and totalizer	Four 8-bit digital I/O channels, two ±12 V analog outputs, and a 100-kHz gated totalizer
34959A Breadboard module	Create your own custom designs with access to the +12 V and +5 V supplies, 16 GPIO ports and 28 relay drive lines

Software accessory	Description
34832A BenchLink Data Logger Pro	Software that provides limit checking and decision making in addition to collecting and analyzing data

Web Link

www.agilent.com/find/34980A

- LXI Class C compliant
- Small, 1U, half-rack size
- Built-in Ethernet connectivity
- Full-featured graphical Web interface
- Standard Dsub connectors for flexible connection options
- Software drivers for most common programming environments

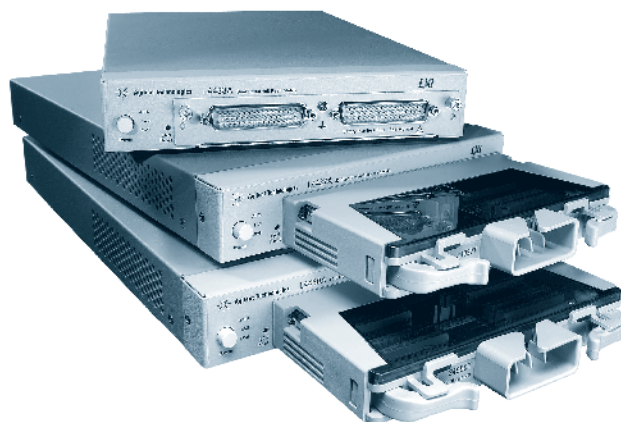

L4400 Series offers a broad range of functionality to meet a wide variety of application needs in design verification, automated test and data acquisition

- L4400 Series
- L4421A
- L4433A
- L4437A
- L4445A
- L4450A
- L4451A
- L4452A

The Agilent L4400 Series LXI instruments are high-performance LXI Class C compliant instruments that encompass all benefits of LXI with an Ethernet connection, instrument Web server, standard software drivers and more. With their small size and Ethernet connectivity, these instruments are easily placed anywhere on the network.

L4400 Series LXI Instruments

Switching, digital I/O, analog outputs and counter functionality in compact, self-contained LXI instruments.

Low frequency switching

		Max volts	Max current	Scan Ch/s
L4421A	40 Channel armature mux	±300 V	1 A	100
L4433A	Dual 4x8 reed matrix	±150 V	0.5 A	500
L4437A	28 Channel Form C	300 V	1 A	—
	4 Channel Form A	30 VDC/ 250 VAC	5 A	—

RF and microwave switching

L4445A	Microwave switch/attenuator driver	Drive up to 64 external switch coils; 32 SPDT switches, 8 multiport switches, 8 attenuators, or custom combination		
--------	------------------------------------	--	--	--

System measurement and control

L4450A	64-bit digital I/O with memory and counter	Eight 8-bit digital I/O channels with programmable polarity, thresholds up to 5 V with handshaking protocols and 128 kB pattern memory. Two 10 MHz frequency counters and programmable clock output		
L4451A	4-channel isolated D/A converter with memory	Output DCV up to ±16 V or DC current up to ±20 mA, output waveforms w/200 kHz update rate and 16 bit resolution. 500 k memory for waveforms. Four independent D/A converters		
L4452A	Multifunction module	Four 8-bit digital I/O channels, 2 Channel ±12 V analog outputs, 100 kHz gated totalizer		

Ethernet Connectivity Enables Simple Connection to the Network and Remote Access to your Measurements

You can set up a private network to filter out unwanted LAN traffic and speed up the I/O throughput, or take advantage of the remote capabilities and distribute your tests worldwide.

Use the Built-In Graphical Web Interface for Remote Access and Control of your Instruments via a Java-Enabled Web Browser

Monitor, troubleshoot, or debug your application remotely. The web interface includes features that allow you to view and modify instrument setup, setup and initiate scans or switch sequences, and get status reports on relay counts, firmware revisions and more.

System Connections you can Trust

The L4400 Series instruments come with standard Dsub connectors for simple, reliable connection options that include quick disconnect terminal blocks, cables and connector kits.

Software Drivers and Connection Tools to Work in your Environment

The Agilent IO Libraries Suite makes it easy for you to configure and integrate instruments into your system – even if your system includes instruments from other vendors. Additionally, these instruments include IVI and LabVIEW software drivers making it easy to program in the most popular programming environments including Agilent VEE and T&M Toolkit, National Instruments LabVIEW and LabWindows, and Microsoft programming languages.

Agilent's Family of LXI Instruments offer Versatility

In addition to the L4400 Series LXI instruments, Agilent offers the 34980A switch/measure unit for high-density systems. So whether you need a full-blown switching system with high-density switching, measurement and system control, or just a few channels of switching, Agilent's family of LXI switch/measure instruments have great versatility so you can choose what you need and easily add to it when your requirements change.

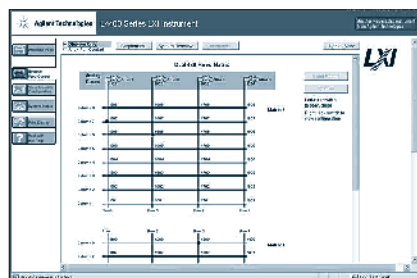

L4433A dual 4 x 8 matrix web interface

Web Link

www.agilent.com/find/L4400

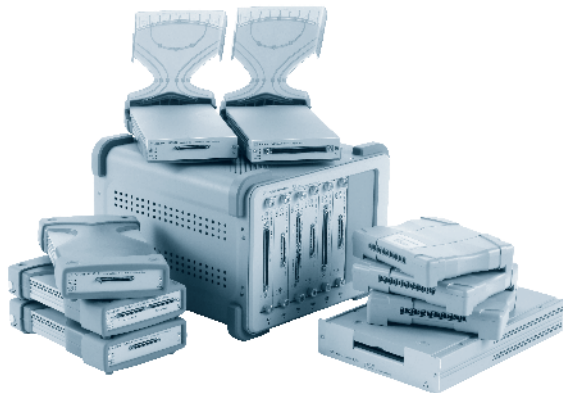

USB modular data acquisition modules

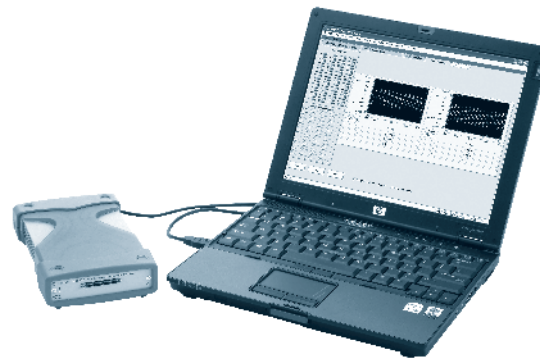

Agilent Measurement Manager (AMM) bundled software for quick setup and data logging to PC

Control, Acquire, Measure, Evolve

The USB data acquisition (DAQ) and switching solution family gives you the choice and flexibility to create solutions that evolve and expand according to your changing measurement needs. You can quickly and easily acquire, measure and analyze data from electrical, mechanical, physical and acoustical phenomena.

The DAQ Series includes multifunction measurement modules, simultaneous-sampling multifunction measurement modules, two types of digital input/output (DIO) devices, and a thermocouple input.

Switching solutions include switch matrix and RF switch driver modules. All (excluding the U2100 Series) can be used side-by-side with Agilent USB modular instruments modules –

standalone or in the six-slot chassis. All modules provide USB 2.0 connectivity (with USBTMC-USB488 standard) and plug-and-play simplicity.

Kick start your measurements with a USB interface to your PC and the familiar, easy-to-use soft front panel – the feature-packed Agilent Measurement Manager (AMM) software included with each instrument.

A Quick Reference to the Agilent USB Modular Data Acquisition Family

Features	U2300A Series multifunction DAQ devices	U2500A Series simultaneous sampling multifunction DAQ devices	U2100A Series digital I/O devices	U2600A Series isolated DIO devices	U2802A thermocouple input device	
Number of models	7	3	3	3	1	
Analog input	Channels/modules, max	64	4	—	31	
	Sampling rate, max	Up to 3 MSa/s (single channel) Up to 1 MSa/s*	Up to 2 MSa/s / channel	—	Up to 500 kSa/s**	
	Resolution	Up to 16-bit	Up to 16-bit	—	—	Up to 16-bit**
	Input voltage, max	10 V	10 V	—	—	10 V**
Analog output	Channels/modules, max	2	2	—	—	2**
	Update rate, max	1 MSa/s	1 MSa/s	—	—	1 MSa/s**
	Resolution	Up to 16-bit	12-bit	—	—	12-bit**
	Output voltage, max	10 V	10 V	—	—	10 V**
Digital I/O	Channels/modules, max	24	24	32	64	—
	Input levels, max	5 V	5 V	24 V	24 V	—
	Output levels, max	5 V	5 V	24 V	35 V	—
Counter	Channels	2	2	—	—	—
	Max count	(2 ³¹ - 1) bits	(2 ³¹ - 1) bits	—	—	—
Software and drivers	Agilent Measurement Manager	Yes	Yes	—	Yes	Yes
	Agilent DIO diagnostics	—	—	Yes	—	—
	IVI-COM	Yes	Yes	Yes	Yes	Yes
	LabVIEW drivers	Yes	Yes	Yes	Yes	—
	MATLAB drivers	Yes	Yes	Yes	Yes	Yes
	SCPI	Yes	Yes	Yes	Yes	—
	Agilent VEE	Yes	Yes	Yes	Yes	Yes
Compatibility with U2781A	Yes	Yes	—	Yes	—	
Synchronization between modules	Yes	Yes	—	Yes	—	

* Aggregate sampling rate (1 MSa/s when more than one channel is used)

** Dependent on selected U2300A module

Web Link

www.agilent.com/find/usbdqa

U2300A Series USB modular multifunction DAQ devices

- Up to 3 MSa/s sampling rate for a single channel
- Up to 384 channels when used in U2781A Agilent modular product chassis
- Powerful analog and digital triggering capabilities
- 24-bit programmable digital I/O
- Two general purpose digital timer/counter capabilities

U2500A Series USB modular simultaneous-sampling multifunction DAQ devices

- Dedicated ADC for each channel with up to 2 MSa/s/channel sampling
- Multifunction: four analog inputs, two analog outputs, 24-bit programmable digital I/O, two general purpose digital counter and timer

U2100A Series USB digital I/O devices

- Up to 32 input terminals and 32 output terminals
- Supports digital inputs ranging from 0 to 24 V
- Opto-isolation with maximum transient voltage of 1500 V_{pk}
- Digital filtering removes unwanted glitches and pulses
- Edge detection monitors state changes on input lines (U2121A/U2122A)
- Fuse-protected output channels (shared by eight terminals)

U2600A Series USB modular isolated digital I/O devices

- 32 or 64 opto-isolated digital input and output lines
- Up to 1250 Vrms of isolation protection on inputs and outputs
- Supports digital inputs of up to 24 V
- 5 to 35 V external supply voltage range for digital output
- On-board isolated +5 V, 150 mA (0.85 W) power supply



U2300A Series



U2500A Series



U2100A Series



U2600A Series

U2300A Series USB Modular Multifunction DAQ Devices

Basic and High-Density DAQ

This high-performance series consists of four basic models and three high-density models. The basic models feature 16 single-ended/eight differential inputs with 16-bit resolution and ± 10 V maximum range. The high-density models offer 64 single-ended/32 differential inputs with 16-bit resolution in the lower-speed models and the 12-bit resolution in high-speed U2331A.

U2500A Series USB Modular Simultaneous-Sampling Multifunction DAQ Devices

Simultaneous Signal Acquisition

This family of three high-performance modules provides up to four channels per module with one analog-to-digital converter (ADC) for each channel. Maximum sampling rates are 2 MSa/s/channel in the U2531A (14 bits), 500 kSa/s/channel in the U2542A (16 bits) and 250 kSa/s/channel in the U2541A (16 bits).

U2100A Series USB Digital I/O Devices

Standalone Digital I/O

This group of three standalone units offers cost-effective DIO for applications such as driving relays, actuators and valves. Equipped with opto-isolation, they can also act as an interface to industrial sensors. Capabilities such as a failsafe watchdog timer and programmable power-up states ensure safe, predictable operation.

U2600A Series USB Modular Isolated Digital I/O Devices

High Channel Count Digital I/O

The three U2600A modules offer digital input and output with high channel count and opto-isolation. Virtual port grouping lets you select any eight input or output bits and group them into a single channel as a virtual DIO port. An interrupt function automatically triggers your system when a digital change of state occurs.

Ordering Information

U2300A Series USB modular multifunction DAQ devices

- U2351A** 16-channel, 250 kSa/s, USB modular multifunction data acquisition
- U2352A** 16-channel, 250 kSa/s, no analog output, USB modular multifunction data acquisition
- U2353A** 16-channel, 500 kSa/s, USB modular multifunction data acquisition
- U2354A** 16-channel, 500 kSa/s, no analog output, USB modular multifunction data acquisition
- U2355A** 64-channel, 250 kSa/s, USB modular multifunction data acquisition
- U2356A** 64-channel, 500 kSa/s, USB modular multifunction data acquisition
- U2331A** 64-channel, 1 MSa/s, USB modular multifunction data acquisition

U2500A Series USB modular simultaneous-sampling multifunction DAQ devices

- U2531A** 2 MSa/s USB modular simultaneous-sampling multifunction DAQ
- U2541A** 250 kSa/s USB modular simultaneous-sampling multifunction DAQ
- U2542A** 500 kSa/s USB modular simultaneous-sampling multifunction DAQ

U2100A Series USB digital I/O devices

- U2121A** 16-input, 16-output DIO module
- U2122A** 32-input digital input module
- U2123A** 32-output digital output module

U2600A Series USB modular isolated digital I/O devices

- U2651A** 32-input, 32-output digital I/O module
- U2652A** 64-input digital input module
- U2653A** 64-output digital output module

Web Link

- www.agilent.com/find/U2300A
- www.agilent.com/find/U2500A
- www.agilent.com/find/U2100A
- www.agilent.com/find/U2600A

U2351A
U2352A
U2353A
U2354A
U2355A
U2356A
U2331A
U2531A
U2541A
U2542A
U2121A
U2122A
U2123A
U2651A
U2652A
U2653A

U2751A

U2751A USB modular switch matrix

- 32 two-wire crosspoints in a flexible 4x8 configuration
- Minimal crosstalk and insertion loss at 45 MHz
- Bundled software provides convenient user interface for quick setup

U2121A-based RF switch solution

- Five channels
- Compatible with Agilent RF switches

U2802A 31-channel thermocouple input module

- Supports thermocouple types J, K, R, S, T, N, E and B
- Includes built-in isothermal terminal block, thermistor and zeroing function
- Provides error detection of open thermocouples
- Independently configurable for thermocouple or voltage-input mode on any channel
- NIST-traceable calibration

U2781A USB modular product chassis

- Six USB module slots
- System synchronous interface (SSI)
- Star trigger and trigger-in/trigger-out signals
- Internal and external 10 MHz reference clock



U2751A

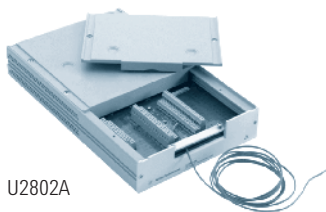

U2802A

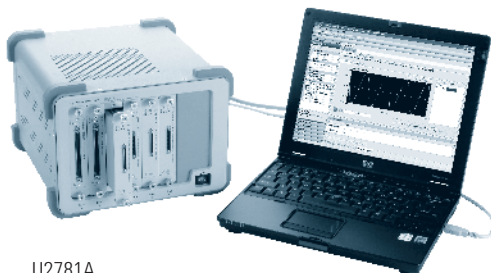

U2781A

U2751A USB Modular Switch Matrix

Switching for Test Automation

The U2751A is a high-quality, low cost switching solution for complex testing. It has 32 two-wire crosspoints in a 4x8 configuration, enabling connection with any combination of rows and columns – including multiple channels at the same time. Other key features are 45-MHz bandwidth (without terminal block), a relay cycle counter, and a command-logger function.

The AMM interface lets you make connections by simply using your mouse to click on crosspoints. The U2751A's flexible configuration enables testing of multiple DUTs as well as allowing different instruments to be connected to multiple points on a DUT at the same time.

RF Switch Driver

The Agilent U2121A-based RF switch solution is a cost-effective, easy-to-use, and convenient way to implement RF switching in small test systems for a variety of applications. The simplified installation, operation of the digital I/O card, and the breakout module allows straightforward control of small RF switching systems.

U2802A 31-Channel Thermocouple Input Module

Temperature Measurements for Thermal Analysis

The Agilent U2802A thermocouple input module is a signal conditioner that converts low-voltage thermocouple signals into a ± 10 volt signal range. The module is designed to be used with the U2355A and U2356A multifunction DAQ modules, connected through two SCSI-II cables. The U2802A is suitable for a wide range of applications in a variety of industrial environments.

Configuration and control is performed through the easy-to-use AMM software, which is included with the U2802A.

The module is also compatible with a wide range of application development environments including Agilent VEE, LabVIEW and Microsoft Visual Studio.

U2781A USB Modular Product Chassis

Integration Made Easy

The U2781A is a six-slot chassis for Agilent USB modular instruments and data acquisition devices. It offers the convenience of one AC-power connection and a single USB link. Modules are hot-swappable and the auto-detection feature reduces setup time and effort. This 4U-high chassis also provides simultaneous synchronization between modules and enables SSI/star-trigger bus synchronization with an external trigger source. The optional rackmount kit simplifies integration into a test system.

The chassis' master/slave triggering capabilities also enable synchronization among various modules. This is possible even across modules with different functions (except for the switch matrix). Its compact size saves space on the bench or in a rack. Hi-speed USB 2.0 compatibility makes connection to a PC quick and easy.

Ordering Information

- U2751A USB modular switch matrix
- U2121A-based RF switch driver
- U2802A 31-channel thermocouple input module
- U2781A 6-slot USB modular product chassis

Web Link

- www.agilent.com/find/U2751A
- www.agilent.com/find/U2121A
- www.agilent.com/find/U2802A
- www.agilent.com/find/U2781A

- **Reliable signal routing from DC to 26.5 GHz**
- **High-speed switches to increase test throughput**
- **High-quality, durable connections to your device under test**
- **Fast and easy test development with Agilent connection expert, Web interfaces and soft front panels as well as software drivers to program in your environment of choice**

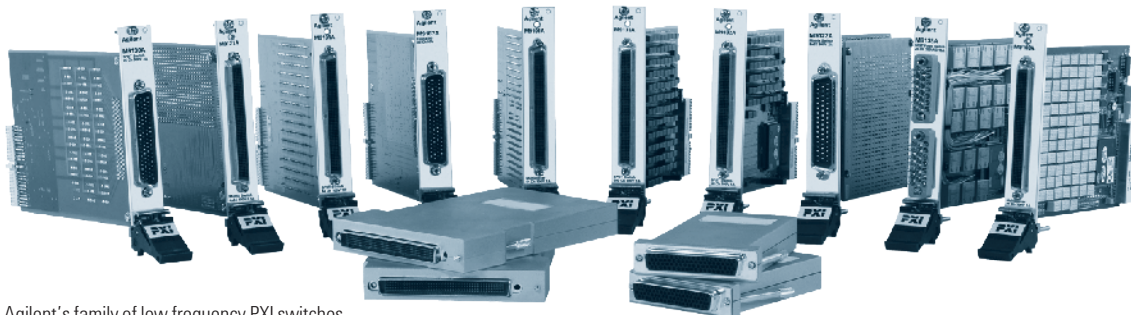

Agilent's family of low frequency PXI switches

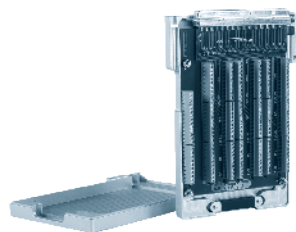

Screw terminal connector blocks

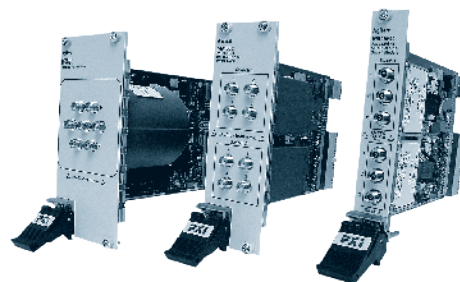

DC to 26.5 GHz switches in multiple configurations

The PXI data acquisition and switch modules deliver modular, high-performance signal connections in the standard PXI platform. Agilent offers a wide selection of performance such as high-speed, 500 μ sec multiplexer relays, high-power, 300 W general purpose switches and high-density 256 2-wire cross point matrix modules. Additionally, RF and microwave switch technology delivers low insertion loss and VSWR for excellent RF signal integrity and dynamic range when routing RF signals into your measurement equipment.

Installation and configuration is fast and easy with standard connectors, soft front panels and Agilent connection expert. In addition, software drivers support the most common programming environments such as Visual Studio, C, C++, Visual Basic, MATLAB and LabVIEW.

Multiplexer Switches

The PXI multiplexer modules deliver high-speed signal routing of many different channels to a single point and are ideal for routing multiple analog signals to a measurement device in automated test environments (ATE) or data acquisition systems. Available in 1-wire or 2-wire configurations, the PXI multiplexer switches can operate in a break-before-make mode, ensuring no two points are connected at the same time, or if needed, multiple channels can be connected simultaneously. Choose between the high-speed, long life reed relays capable of switching up to 100VDC/100VAC with up to 20 W of power, or the higher power electromechanical relays which are capable of switching up to 100VDC/100VAC, with up to 60 W of power.

General Purpose Switches

The PXI general purpose switch modules deliver fast, reliable switching in a variety of configurations. Cycle power to products under test, control indicator and status lights or actuate external power relays and solenoids with independent, single-pole, double-throw (form C) or single-pole, single-throw (form A) switches in a single PXI module. Choose between the high-speed, long-life reed relays capable of switching up to 100VDC/100VAC with up to 1 A and 20 W of power, or the higher power electromechanical relays capable of switching up to 125VDC/250VAC,

with up to 2 A and 60 W of power. The general purpose line also includes a module that can handle up to 300 W/2500 VA for switching heavy loads or power supplies.

Matrix Switches

The PXI matrix switch modules deliver medium to high density switching of multiple channels in a single instance. Any row can be connected to any column which is ideal for routing multiple signals between the device under test and instruments. Up to 256 2-wire crosspoints can be configured in a single module. Choose between the high-speed, long life reed relays capable of switching up to 100VDC/100VAC with up to 20 W of power, or the higher power electromechanical relays which are capable of switching up to 125VDC/250VAC, with up to 60 W of power.

RF Switches

The PXI RF switch modules deliver high-performance, high density switching up to 3 GHz and are available in multiple configurations to integrate into a variety of test environments. Modern RF relay technology delivers low insertion loss and VSWR for excellent RF signal integrity and dynamic range when routing RF signals into your measurement equipment. Select from the full cross point matrix for connecting multiple points at one time to the 1x4 to 1x16 multiplexer configurations for switching multiple points to a single point. Each switch path is carefully designed to ensure repeatable RF performance.

Microwave Switches

The PXI microwave switch modules deliver our exceptional 0.03 dB insertion loss repeatability, high isolation, low VSWR with a long operating life up to 10 million cycles switches in the PXI platform. These switches are ideal in applications such as automatic test equipment (ATE), RF communications measurement and RF parametric measurements where a rugged switching module is needed in a high density switching systems. The modules operate from a frequency range of DC to 26.5 GHz and are available with dual SPDT switches, dual transfer switches and a single SP6T switch.

- M9101A
- M9102A
- M9103A
- M9120A
- M9121A
- M9122A
- M9128A
- M9130A
- M9131A
- M9132A
- M9133A
- M9135A
- M9146A
- M9147A
- M9148A
- M9149A
- M9150A
- M9151A
- M9152A
- M9153A
- M9155C
- M9156C
- M9157C

PXI Data Acquisition and Switching Modules

268

PXI Switching from DC to 26.5 GHz (cont.)

M9101A
M9102A
M9103A
M9120A
M9121A
M9122A
M9128A
M9130A
M9131A
M9132A
M9133A
M9135A
M9146A
M9147A
M9148A
M9149A
M9150A
M9151A
M9152A
M9153A
M9155C
M9156C
M9157C

	Data acquisition & switching	Description	Type # slots	Channels/crosspoints	Switching Speed (typical)	Max voltage	Current Switch & Carry	Relay type	Connectors
	Multiplexers	M9101A	PXI x1	64 channels, 2-wire	500 µsec	100VDC/100VAC	0.5 A/1 A	Reed	Connector block or cable
		M9102A	PXI x1	128 channels, 1-wire	500 µsec	100VDC/100VAC	0.5 A/1 A	Reed	Connector block or cable
		M9103A	PXI x1	99 channels, 2-wire	3 msec	100VDC/100VAC	1 A/1 A	Electromechanical	Connector block or cable
	Matrix switches	M9120A	PXI x1	4 x 32, 2-wire	3 mS	125VDC/250VAC	2 A/2 A	Electromechanical	Connector block or cable
		M9121A	PXI x1	4 x 64, 2-wire	1 mS	100VDC/100VAC	0.5 A/0.5 A	Reed	Connector block or cable
		M9122A	PXI x1	8 x 32, 1-wire	3 mS	Contact factory	2 A/2 A	Electromechanical	Connector block or cable
	General purpose switches	M9130A	PXI x1	26 form C	3 msec	300VDC/250VAC	2 A/2 A	Electromechanical	Connector block or cable
		M9131A	PXI x1	64 form C	500 µsec	Contact factory	1 A/1 A	Reed	Connector block or cable
		M9132A	PXI x1	50 form A	500 µsec	100VDC/100VAC	1 A/1 A	Reed	Connector block or cable
		M9133A	PXI x1	100 form A	500 µsec	100VDC/100VAC	1 A/1 A	Reed	Connector block or cable
		M9135A	PXI x1	20 form A	10.5 ms	Contact factory	10 A/10 A	Electromechanical	Connector block or cable

		Description	Type # slots	Frequency Range	Insertion Loss (typical)	Isolation (typical)	VSWR (typical)	Impedance	Connectors
RF switches (typical)	M9128A	8 x 12 RF matrix switch	PXI x1	300 Mhz	3 dB @ 300 MHz	80 dB @ 300 MHz	1:2.1 @ 300 MHz	50 Ω	SMB connectors
	M9146A	Dual 1 x 4 RF multiplexer	PXI x1	3 GHz	1 dB @ 3 GHz	45 dB @ 3 GHz	1.3:1 @ 3 GHz	50 Ω, off chan termination	SMB connectors
	M9147A	Quad 1 x 4 RF multiplexer	PXI x1	3 GHz	1.3 dB @ 3 GHz	35 dB @ 3 GHz	1.5:1 @ 3 GHz	50 Ω	SMB connectors
	M9148A	1 x 8 RF multiplexer	PXI x1	3 GHz	1.2 dB @ 3 GHz	38 dB @ 3 GHz	1.2:1 @ 3 GHz	50 Ω	SMB connectors
	M9149A	1 x 16 High density RF multiplexer	PXI x1	3 GHz	1.3 dB @ 3 GHz	38 dB @ 3 GHz	1.4:1 @ 3 GHz	50 Ω	SMB connectors
	M9150A	Dual 1 x 4 RF multiplexer	PXI x1	3 GHz	1.6 dB @ 3 GHz	40 dB @ 3 GHz	1.6:1 @ 3 GHz	75 Ω	SMB connectors
	M9151A	Quad 1 x 4 RF multiplexer	PXI x1	3 GHz	1.6 dB @ 3 GHz	40 dB @ 3 GHz	1.6:1 @ 3 GHz	75 Ω	SMB connectors
	M9152A	1 x 8 RF multiplexer	PXI x1	3 GHz	2.1 dB @ 3 GHz	39 dB @ 3 GHz	1.5:1 @ 3 GHz	75 Ω	SMB connectors
	M9153A	1 x 16 RF multiplexer	PXI x1	3 GHz	1.9 dB @ 3 GHz	38 dB @ 3 GHz	1.6:1 @ 3 GHz	75 Ω	SMB connectors
uWave switches	M9155C	Dual SPDT switch	PXI-H 1 slot	DC – 26.5 GHz	DC: 0.25 dB 8 GHz: 0.47 dB 12.4 GHz: 0.58 dB 18 GHz: 0.74 dB 26.5 GHz: 0.96 dB	DC: 110 dB 8 GHz: 92 dB 12.4 GHz: 82 dB 18 GHz: 70 dB 26.5 GHz: 50 dB	DC – 4 GHz: 1.25 4 – 18 GHz: 1.45 18 – 26.5 GHz: 1.70	50 Ω	3.5 mm (f)
	M9156C	Dual transfer switch	PXI-H 2 slots	DC – 26.5 GHz	DC: 0.20 dB 8 GHz: 0.40 dB 12.4 GHz: 0.51 dB 18 GHz: 0.65 dB 26.5 GHz: 0.86 dB	DC: 110 dB 8 GHz: 94 dB 12.4 GHz: 85 dB 18 GHz: 74 dB 26.5 GHz: 57 dB	DC – 2 GHz: 1.10 2 – 4 GHz: 1.15 4 – 12.4 GHz: 1.25 12.4 – 20 GHz: 1.40 20 – 26.5 GHz: 1.65	50 Ω	SMA (f)
	M9157C	Single SP6T switch	PXI-H 3 slots	DC – 26.5 GHz	DC: 0.30 dB 8 GHz: 0.42 dB 12.4 GHz: 0.49 dB 18 GHz: 0.57 dB 26.5 GHz: 0.70 dB	DC – 12 GHz: 90 dB 12 – 15 GHz: 70 dB 15 – 20 GHz: 65 dB 20 – 26.5 GHz: 60 dB	DC – 4 GHz: 1.20 4 – 12.4 GHz: 1.35 12.4 – 20 GHz: 1.45 20 – 26.5 GHz: 1.70	50 Ω	SMA (f)

Web Link

www.agilent.com/find/pxi-switch

- The flexible design of the 8960 Series 10 supports multiple modes and wireless technologies in a single chassis
- Provides all the features and functionality you need for fast, accurate, repeatable, and automated testing of today's most popular wireless formats
- Supports GSM/GPRS, EGPRS, E-EDGE, TD-SCDMA, W-CDMA, HSDPA, HSUPA, HSPA+, IS-95, cdma2000, 1xEV-DO, 1xEV-DO Release A and B, eHRPD, TIA/EIA-136, and AMPS
- Lab applications and other enhancements accelerate the pace of product development and help move your design from the lab into manufacturing in the shortest possible time
- Fast-settling hardware eliminates waiting for the measurement path to stabilize
- Separate analog-to-digital converters for measurements eliminate the wait for shared resources, allowing protocol, receiver, and transmitter measurements to run simultaneously
- Separate processors and receivers handle the link maintenance and make RF measurements
- Hardware speed is optimized using fast processing algorithms and the latest processor technology

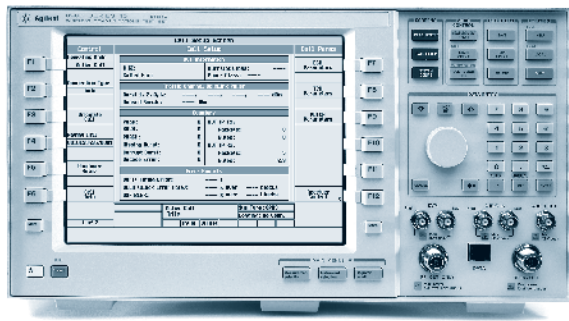

The Agilent 8960 Series 10 wireless communication test set offers mobile manufacturers *immediate competitive advantages*. Developed for high-volume, automated mobile phone manufacturing test, the proven 8960 Series 10 test set offers *speed, accuracy, repeatability, multi-format capability, ease of programming, and format-flexible* architecture. For the mobile manufacturer, this translates into lower test costs and higher production output to help meet customer demand for phones now and into the future.

For wireless device development, the Agilent 8960 offers essential parametric measurement plus flexible protocol triggering/analysis, and network emulation with full connectivity to the Internet. The 8960's network simulation and software verification tools are designed specifically for the needs of wireless developers doing software design verification and integration. These test solutions offer realistic network simulation and give you Internet connectivity with real data traffic flows. Additional capability is provided with extensive real-time protocol logging and analysis tools.

The 8960 Series 10 can be configured for GSM/GPRS, EGPRS, E-EDGE, TD-SCDMA, W-CDMA, HSDPA, HSUPA, HSPA+, IS-95, cdma2000, 1xEV-DO, 1xEV-DO Release A and B, eHRPD, TIA/EIA-136, and AMPS mobile phone testing and device development.

Specifications

Detailed specifications are found in the data sheets for the individual test applications and lab applications.

Accessories

8960 Series 10 test applications and lab applications

- E1961A AMPS/136 mobile test application
- E1962B cdma2000/IS-95/AMPS mobile test application
- E1963A W-CDMA mobile test application
- E1966A 1xEV-DO terminal test application
- E1968A GSM/GPRS/EGPRS mobile test application
- E1969A TD-SCDMA_GSM fast switch test application
- E1976A 1xEV-DO factory test mode test application
- E1987A fast switching mobile test application
- E1991B 8960 Series 10 test application suite
- E1993A UMTS test application suite
- E1996A cdma2000/1xEV-DO test application suite
- E6701H GSM/GPRS lab application
- E6702D cdma2000 lab application
- E6703G W-CDMA lab application
- E6704A EGPRS lab application
- E6706D 1xEV-DO lab application
- E6785G GSM/GPRS/EGPRS_W-CDMA lab application (fast switching)
- E6716D cdma2000/1xEV-DO lab application suite
- E6717E UMTS lab application suite
- E6719G lab application suite

Wireless test manager test automation software

- E6567C cdma2000/IS-95/AMPS/1xEV-DO wireless test manager
- E6568C W-CDMA/GSM/GPRS wireless test manager
- E6569C wireless test manager suite
- N5880A cdma2000/IS-95/AMPS enhanced wireless test manager
- N5882A W-CDMA enhanced wireless test manager
- N5884A 1xEV-DO enhanced wireless test manager

Interactive functional test software

- N5970A UMTS interactive functional test software
- N5971A CDMA interactive functional test software

Ordering Information

- E5515C wireless communications test set
 - E5515C-002 2nd RF source
 - E5515C-003 flexible CDMA base station emulator
 - E5515C-004 digital bus

For detailed configuration information, refer to the 8960 configuration guide (5968-7873E) at www.agilent.com/find/8960config

Web Link

- www.agilent.com/find/8960
- www.agilent.com/find/8960downloads

E6701H

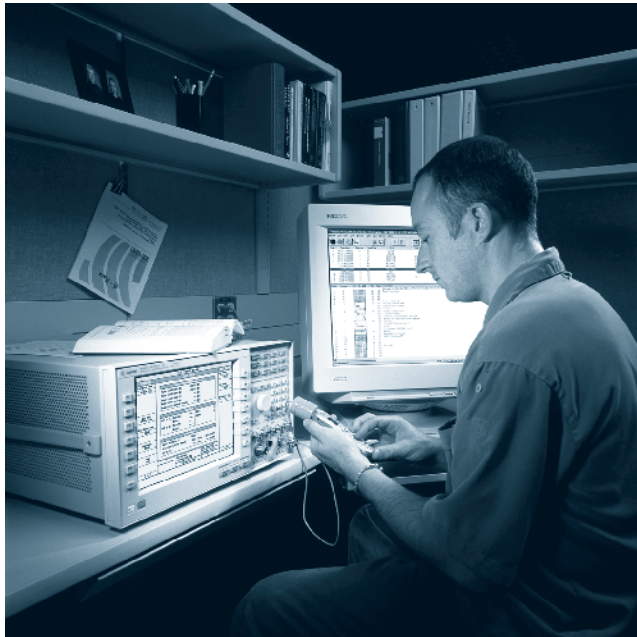

The Agilent E6701H lab application software (with optional E6704A EGPRS software) runs on the industry standard 8960 (E5515C) wireless communications test set providing network emulation and mobile device integration, validation and regression tools designed specifically for the needs of wireless developers. This test solution offers realistic network emulation and Internet connectivity with real data traffic flows and extensive real-time protocol logging and analysis tools.

The Agilent E6701H GSM/GPRS (Optional E6704A EGPRS) lab application provides the incredibly successful E5515C (8960) wireless communications test set with a long list of analysis features for RF, applications, mobility, services, and protocol. Whether you design, integrate, debug, or validate wireless devices, the E6701H, with its breadth of capabilities, will help you deliver mobile devices that hit your market window.

- *RF engineers* – get your transmitter and receiver validated before the mobile protocol stack is complete with our non-signaling modes
- *QA managers* – regression test all your devices existing functionality including, AMR, SMS/MMS, plus the latest GSM /GPRS/EGPRS/ E-EDGE enhancements
- *Pre-conformance and conformance engineers* – the 8960 can be used within or in conjunction with the GS-8800 design verification and conformance test systems
- *Software application engineers, integration and validation engineers* – test simultaneous voice or data connections while sending an SMS or MMS, FTP, UDP, email, or other real-world user activities to rapidly resolve or device to device interoperability issues. Find end-user issues earlier and resolve them faster with the N5970A UMTS interactive functional test software

Specifications

Ensure mobile designs, applications, and services meet your customers' expectations

- Evolved EDGE capability including downlink dual carrier (DLDC) and fast Ack/Nack reporting (FANR)
- Higher order downlink modulation formats supporting EGPRS2-A including 16QAM and 32QAM
- UMA/GAN including E6962B GAN controller
- Application testing, such as A-GPS functional testing, battery drain analysis, fixed mobile convergence, simulating real-world fading, and high-speed data throughput testing
- Audio quality test – PESQ (with E1999A-301), digital audio interface, real time Vocoder with 8PSK WB-AMR and AMR
- Ciphering with E6705A GSM/(E)GPRS encryption functionality
- 2-Cell inter-RAT handovers
- Services testing such as SMS/MMS
- Class 12 and Class 30-34 signaling and packet data throughput, Class 40-45 signaling

Verify designs meet RF specifications as specified in the 3GPP standards

- Flexible GSM/GPRS (optional (E)EGPRS) measurements
- Mobile measurement reports
- RF measurement support for up to 6 timeslots

Accessories

E6785G fast switching lab application

N5970A UMTS interactive functional test software: reduce development cycle times by enabling functional testing of UMTS mobile devices using realistic end-user scenarios.

Ordering Information

E6701H GSM/GPRS lab application

E6701HU GSM/GPRS lab application upgrade

E6704A EGPRS lab application

E6705A GSM/GPRS/EGPRS encryption functionality for mobile test

E6720A-001 GSM/GPRS annual contract

E6720A-201 annual contract extension

For detailed configuration information, refer to the 8960 configuration guide (5968-7873E) at www.agilent.com/find/8960config

Web Link

www.agilent.com/find/E6701H

www.agilent.com/find/E6785G

www.agilent.com/find/N5970A

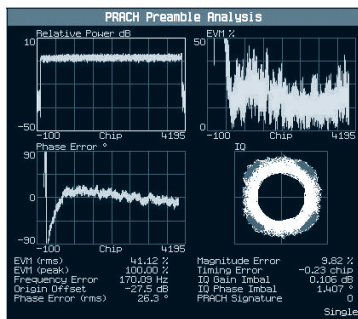
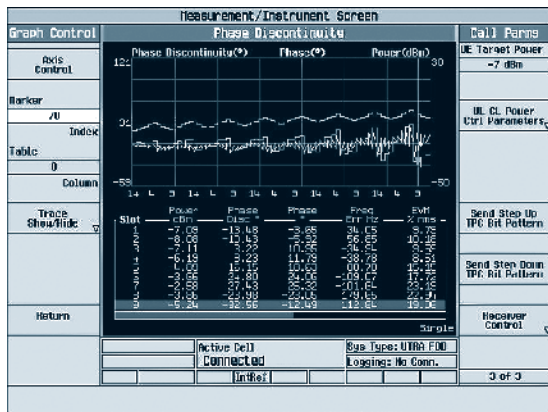

The Agilent E6703G lab application software runs on the industry standard 8960 (E5515C) wireless communications test set providing network emulation and mobile device design, integration, and validation test tools designed specifically for the needs of wireless developers. This test solution offers the highest sustained packet-switched data rates, most 3GPP standards-compliant RF measurements, real-time protocol logging, optional digital fading, and useful analysis tools.

The Agilent E6703G W-CDMA/HSPA lab application combined with the successful E5515C (8960) wireless communications test set provides network simulation and software verification tools designed specifically for the needs of wireless developers integrating and verifying a wide range of hardware and software design. This test solution offers realistic network simulation and gives you Internet connectivity with real data traffic flows. Additional capability is provided with extensive real-time protocol logging and analysis tools.

- *RF engineers* – validate transmitter and receiver performance before the mobile protocol stack is integrated, as well as verify operation after protocol is integrated
- *QA managers* – regression test all your devices existing functionality, including, SMS/MMS, plus the latest W-CDMA/HSPA enhancements, and the capability to test during inter and intraRAT handovers
- *Pre-conformance and conformance engineers* – the 8960 can be used within or in conjunction with the GS-8800 design verification and conformance test systems
- *Software application engineers* – test voice or data connections while sending an SMS or MMS, FTP, UDP, email, or other real-world user activities to rapidly resolve inter service or device to device interoperability issues. Find end-user issues earlier and resolve them faster with the N5970A UMTS interactive functional test software

Specifications

Ensure mobile designs, applications, and services meet your customers' expectations

- HSPA+ 21 Mbps downlink; HSPA+ 11 Mbps uplink
- 14.4 Mbps HSDPA; 5.7 Mbps HSUPA
- Multiple PDP contexts
- RRC state transitions including CELL_FACH
- Application testing, such as A-GPS functional testing, battery drain analysis, fixed mobile convergence, simulating real-world fading, and high-speed data throughput testing
- Simultaneous services
- 2-Cell inter-RAT handovers, 3G-3G soft handovers
- UMA/GAN including E6962B GAN controller
- Ciphering with E6715A W-CDMA/HSPA encryption license
- End-to-end voice or video test, loopback video test
- Services testing such as SMS/MMS
- Audio quality test – PESQ (with E1999A-301), digital audio interface, and real time vocoder
- Compressed mode operation

Verify designs meet RF specifications as specified in the 3GPP standards

- Flexible W-CDMA/HSPA test modes
- UE measurement reports
- RF measurements support up to HSDPA category 14 devices
- Complete suite of TX/RX RF measurements to support 3GPP TS 34.121

Accessories

E6785G fast switching lab application

N5970A UMTS interactive functional test software: reduce development cycle times by enabling functional testing of UMTS mobile devices using realistic end-user scenarios.

Ordering Information

E6703G W-CDMA/HSPA lab application

E6703GU W-CDMA/HSPA lab application upgrade

E6715A W-CDMA/HSPA encryption

E6720A-003 W-CDMA/HSPA annual contract

E6720A-203 W-CDMA/HSPA annual contract extension

For detailed configuration information, refer to the 8960 configuration guide (5968-7873E) at www.agilent.com/find/8960config

Web Link

www.agilent.com/find/E6703G

www.agilent.com/find/N5970A

- Provides individualized early notification of lab application product functionality updates and enhancements
- Provides access to pre-release revisions of lab application product updates and enhancements
- Provides lab application updates during the term of the contract for no additional charge
- New firmware and licenses (if required) are delivered electronically on demand via the web
- Order Option 001 for E6701I, Option 002 for E6702E, Option 003 for E6703H, and Option 006 for E6706E

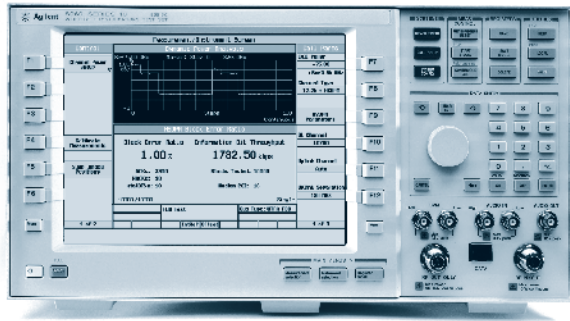

With rapidly evolving standards and the continuing stream of new product features, the E6720A lab application annual contract offers an edge for getting reliable products to market quickly. By ordering an annual contract, you get all new releases coming out in the next year for Agilent's powerful lab applications including subscription releases that are only available with the contract. Provides a permanent license for the next product revision (i.e., E6703G to E6703H) of the lab application. The features are not available without the contract. You get all releases for that license (i.e., E6703H) until a new license (i.e., E6703I) is released whether or not the annual contract is expired. The E6720A optimizes your ability to quickly isolate and resolve product faults and incompatibility issues, and prevent manufacturing delays.

Technology	Annual contract	Annual contract extension
GSM/GPRS/EGPRS	E6720A-001	E6720A-201
W-CDMA/HSDPA	E6720A-003	E6720A-203
cdma2000	E6720-002	E6720A-202
1xEV-DO	E6720A-006	E6720A-206
UMTS*	E6720A-017	E6720A-217

* E6720A-017 combines 001 and 003, E6720A-217 combines 201 and 203

Note 1: The annual contract extension is to avoid overlap when renewing your existing annual contract

Note 2: To purchase the E6720A annual contract, you must have the most current lab application product

Useful Links for Current Contract Users

What	How used
Software manager page	Initial signup and license kit ordering
Software license page	Application license redemption
Application download page	Getting the latest lab application software releases
E6720A quick reference guide	Guide that takes you through all the steps above. (PDF format)
8960 news	Get the latest information on 8960 applications and features

Ordering Information

E6720A lab application annual contract

E6720A-001 GSM/GPRS

E6720A-002 cdma2000

E6720A-003 W-CDMA

E6720A-006 1xEV-DO

E6720A-017 annual contract for UMTS lab application suite

E6720A-201 annual contract extension of E6720A-001

E6720A-202 annual contract extension of E6720A-002

E6720A-203 annual contract extension of E6720A-003

E6720A-206 annual contract extension of E6720A-006

E6720A-217 annual contract extension of E6720A-017

For detailed configuration information, refer to the 8960 configuration guide (5968-7873E) at www.agilent.com/find/8960config

Web Link

www.agilent.com/find/E6720A

E6584A
N5970A
N5971A

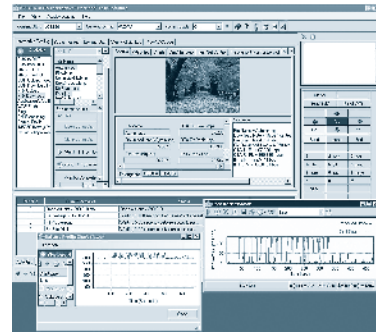
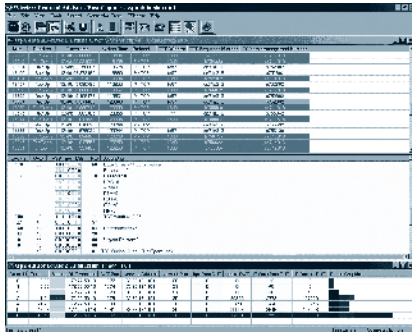

Interactive functional test software user interface and troubleshooting tools

Wireless Protocol Advisor Products

- Multi-format support for key wireless technologies: GSM, GPRS, EGPRS, E-EDGE cdma2000, 1xEV-DO, W-CDMA, and HSPA
- Real time logging of Layer 1, 2, and 3 protocol
- Free post-capture analysis of protocol log files for a separate PC
- Now log data from 2 cell-site emulators
- Connection trace feature tracks TCP/IP messaging and throughput
- Configurable trigger settings make it easy to sort through the huge volume of messaging to and from the mobile
- Configurable views and logging options provide additional flexibility
- Color tagging and graphical representations highlight areas of interest

Features of emerging mobile devices are increasing in complexity and software content. Only by testing these features in a realistic mobile environment can you ensure the quality of your wireless subscriber equipment. So what's the easiest way to expedite production without compromising quality?

Use the flexible and powerful E6584A wireless protocol advisor software with your wireless communications test set and lab application. This product trio creates a complete *network in a box* – giving you a single box test solution for emulating real-life wireless applications. You'll be able to quickly collect and interpret wireless protocol messaging, verify functionality, and isolate and resolve protocol problems when developing new wireless products or applications. Take a look below at the features of this software.

One Product, Multi-Format Support

The wireless protocol advisor software is included with every lab application allowing you to analyze files on a separate PC without having to purchase a new license.

Discover Its Power

Take a closer look at the wireless protocol advisor software today! See the demonstration version download in the E6584A key library online.

Accessories

E5515C wireless communications test set lab applications

Ordering Information

Available for download at www.agilent.com/find/E6584A

For detailed configuration information, refer to the 8960 configuration guide (5968-7873E) at www.agilent.com/find/8960config

Web Link

www.agilent.com/find/E6584A

Functional Test Software Products

- Test smartphones and handsets with comprehensive real-world test scenarios
- Ensure mobile applications and services perform as expected – Test user activities including SMS, MMS, FTP, UDP, and more
- Quickly find and troubleshoot more end-user issues before deploying a device in the field
- Find functional issues with hardware, protocol, operating systems and applications
- Analyze functional failures with troubleshooting toolset including data throughput metrics, activity logs, and more

The Agilent interactive functional test (IFT) software is designed to fully utilize the E5515C (8960) wireless communications test set along with the GSM/GPRS/EGPRS, W-CDMA/HSPA, cdma2000, and 1xEV-DO lab applications. IFT provides an automated and simplified interface for realistically testing user experiences by stress testing cellular mobile devices with real-world user scenarios.

Real-world testing is achieved by IFT's ability to easily set up and dynamically automate realistic user scenarios through the network emulation capabilities of the 8960. The ability to simultaneously run multiple activities, just as an end-user does, is key to emulating real-world scenarios. For example, engineers can simultaneously test call processing, FTP, and SMS, all while monitoring current drain and changing the RF power to the device under test (DUT). This allows integration and validation test engineers to quickly solve issues not normally found until later in the design cycle. Issues found early and resolved quickly can reduce both time-to-market and overall development costs.

Specifications

User activities for parallel test

- SMS and MMS to and from the device
- FTP and UDP upload/download
- Web browsing
- E-mail to and from the device
- WAP push
- Inter-rat handovers
- Mobile reported data
- Network impairments (dynamic cell power levels, AWGN, and scripted fading profiles)

Real-world battery drain analysis

- Go beyond "Talk Time" test and test with realistic user profiles
- Measure voltage and current characteristics of your mobile device
- Correlate measured data with real-world stimulus

Ordering Information

N5970A UMTS interactive functional test software
N5971A CDMA interactive functional test software

Web Link

www.agilent.com/find/N5970A
www.agilent.com/find/N5971A

- Software family supports cdma2000, IS-95, 1xEV-DO, W-CDMA, GSM, GPRS, EGPRS, *Bluetooth* and AMPS
- Technology specific, pre-defined automated test plans help you start testing immediately
- High-level, technology specific test steps make for compact, easy to read test plans
- Simple and powerful test step sequencer for fast custom test development
- Common, easy-to-use operator interface decreases training time and operator errors
- Simple interface to set test parameters, limits and system hardware configuration simplifies customization and support
- Common Microsoft, Visual Basic.NET based development for powerful test and calibration program/debug capability
- Integrated test wizard reduces the programming required to add custom tests and hardware
- Windows PC compatible including XP, 2000, NT and 98 second edition
- Integrated HELP application for test executive and measurement technology assistance

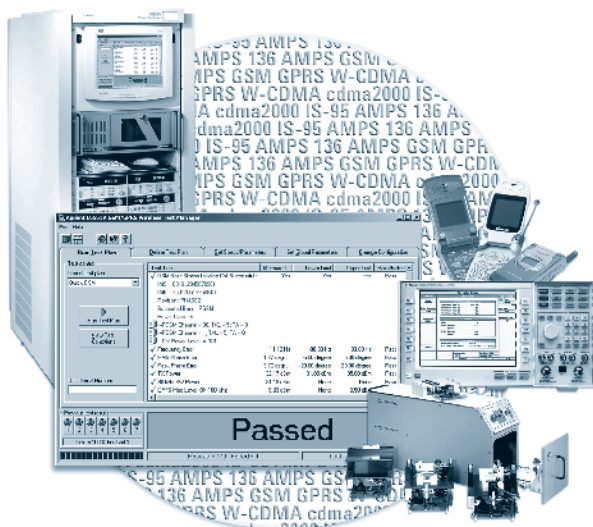

Revolutionize the Automation of Test to Get Your Wireless Device to Market Quickly and Reduce Test Cost

Agilent's wireless test manager is a family of test automation software for wireless device calibration and test. The wireless test manager supports most popular wireless technologies. Developed for a Windows PC, the wireless test manager controls Agilent test sets and other test system hardware via GPIB and serial interfaces. Features include ready-to-use tests, pre-defined test plans, customizable test sequencing, an integrated Visual Basic test development environment and custom application development utilities.

Multiple Technologies

Available for the key wireless technologies, the wireless test manager products support W-CDMA, cdma2000, 1xEV-DO, IS-95, GSM, GPRS, EGPRS, *Bluetooth*, WLAN, IS-136 (TDMA) and AMPS testing.

Simplify and Expedite Test Efforts

Designed specifically for test engineers, the test manager eliminates the frustrating complexity associated with automating device testing. Why struggle with computer control and data management issues, when the test manager lets you focus on test?

Use Agilent or Custom Test Plans

Run a pre-defined Agilent test plan, customize an existing plan, or create your own custom test plan. The test manager makes it easy to modify test parameters, adjust test limits, change the order of test steps, or build your own test plan – without programming.

Create Custom Test Steps

To guide you through the process of adding your own custom test steps, the test manager features a test wizard. Tests created with the wizard and Visual Basic are added to the test menu and can be used in a custom test plan without additional programming.

Flexibility to Meet Your Test Needs

The wireless test manager makes it easy to configure system hardware. It provides for point and click set-up of select Agilent test sets, power supplies, bar code readers, test fixtures, and printers. Other instruments can be added using a wizard. Plus the test manager gives you the flexibility to save test results for further analysis, and set run conditions to stop, continue, or retry on failure. For more information on the adaptable wireless test manager, visit the product pages on the Web.

Common Software Savings

The wireless test manager is easy to learn and simple to use. You will not have to learn complex applications and multiple programming languages to support calibration and testing. Since wireless test manager interfaces and development tools are common for all products, leveraging your knowledge across wireless technologies has never been easier.

Specifications

The tests supported for each technology include call processing, transmitter, receiver, general and fast-combined tests. To review the supported tests, PC requirements and supported hardware go to www.agilent.com/find/wtm and select a product/technology then select the technical overview (or product overview) for that product.

Accessories

8960 Series 10 test applications and lab applications

Ordering Information

Standard wireless test managers

N4019C for *Bluetooth* and WLAN

N5880A for cdma2000/IS-95/AMPS enhanced wireless test manager

N5882A for W-CDMA enhanced wireless test manager

N5884A for 1xEV-DO enhanced wireless test manager

Run-time, combination and suite wireless test managers

E6567C for cdma2000, IS-95, AMPS, 1xEV-DO

E6568C for W-CDMA, GSM, GPRS, and EGPRS

E6569C suite (includes E6567C, E6568C)

E6571C run-time license

N4018C *Bluetooth* and WLAN run-time license

For detailed configuration information, click the wireless test manager configuration guide link in the key library information section at www.agilent.com/find/wtm

Web Link

www.agilent.com/find/wtm

E6567C
E6568C
E6569C
E6571C
N4018C
N4019C
N5880A
N5882A
N5884A

E1968A

- Supports GSM, GPRS, EGPRS and E-EDGE Evolution
- Call processing capability (complying with 3GPP TS51.010 specification)
- Test mode and CW mode
- FM radio and single channel GPS signal generation
- Multi-slot Class 45 TXP and PVT measurement
- Fast device tune for mobile phone calibration
- Phase and amplitude versus time enhancement measurement
- Fast switch capable with other technology formats

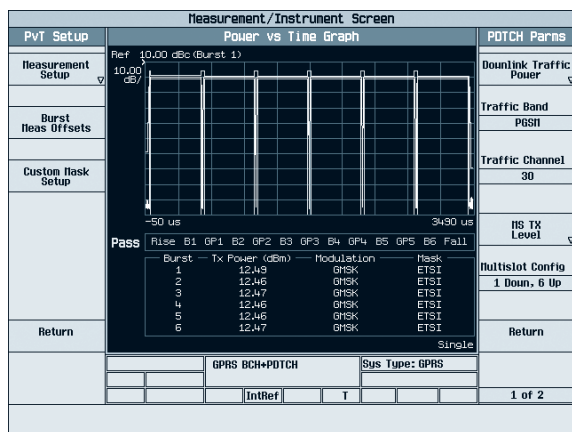

The E1968A GSM/GPRS/EGPRS mobile test application for the 8960 (E5515C) wireless communications test set provides critical capabilities to verify the performance of your GSM, GPRS and EGPRS mobile devices with both signaling and non-signaling mode. Evolved EDGE (E-EDGE) is supported now as a feature option. This test application, designed for high-volume manufacturing and wireless device development, helps you achieve your time-to-market goals for GSM, GPRS and EGPRS wireless devices. Special calibration features, such as Fast Device Tune (FDT), Phase and Amplitude versus Time (PAvT), IQ capture, and EGPRS AM-PM alignment will reduce phone calibration time significantly. Enhanced audio measurement, complete SMS test functionality, 8PSK random frequency offset will enable effective phone development and design. Single Channel GPS source, simulating one satellite signal, and FM broadcast signal source are additional capabilities available to speed GPS and FM receiver calibration.

With E-EDGE option, you can perform E-EDGE phone connection and relevant measurements, such as Reduced Transmission Time Interval (RTTI), and Downlink Dual Carrier (DLDC). DLDC allows you to assign EGPRS PDTCH resources to a mobile on two different carriers and RTTI configuration allows you to reduce the data transfer latency of an EGPRS PDTCH block.

Fast device tune allows simultaneous calibration of a device's transmitter and receiver across level and frequency in a single sweep (per frequency band) to significantly reduce calibration time during manufacturing.

Specifications

GSM functionality

- Traffic channels: TCH/FS – FR, EFR, HR and AMR speech modes
- Broadcast channel configuration: BCCH + CCCH + SDCCH/4
- Signaling protocol setup: FACCH audio speech echo with up to 4s delay

GPRS functionality

- Multislot classes supported: up to Class 45
- Control channels: BCH on timeslot 0 on any ARFCN in any band
- Broadcast channel configuration: FCCH + SCH + BCCH + CCCH + SDCCH/4 (0-3) + SACCH/C4 (0-3)

EGPRS functionality

- Multislot classes supported: up to Class 45
- Control channels: BCH on timeslot 0 on any ARFCN in any band
- Broadcast channel configuration: FCCH + SCH + BCCH + CCCH + SDCCH/4 (0-3) + SACCH/C4 (0-3)

Integrated GSM, GPRS, and EGPRS functionality

- Switch between GSM, GPRS, and EGPRS serving cells
- Switch between data and voice connections without losing camp or attach
- Establish a voice or data connection after initial GPRS attach

Audio functionality

- Choice of speech encoded on downlink TCH: none, echo, 300 Hz sine, 1 kHz sine, 3 kHz sine or PRBS-15, multi-tone, or custom
- Real time encoder and decoder supported
- GSM analog audio measurement (audio level, distortion, frequency, SINAD)

Receiver measurements

- GSM burst-by-burst bit error ratio (fast BER)
- GSM bit error ratio (BER)
- GPRS/EGPRS multislot BER
- GPRS/EGPRS multislot block error ratio (BLER)

Transmitter measurements

- GSM/GPRS/EGPRS multi-slot transmit power
- 8PSK multislot-tolerant modulation accuracy (peak, rms, 95th percentile and sample EVM; frequency, magnitude and phase errors, origin offset suppression; IQ imbalance)
- GMSK multislot-tolerant frequency error
- GMSK multislot-tolerant phase error (peak and rms with confidence limits)
- 16QAM multislot burst power and modulation accuracy
- Multislot power versus time (burst mask comparison with settable masks)
- Burst timing
- Multislot-tolerant output RF spectrum due to modulation and switching
- IQ tuning
- GSM decoded audio level
- Dynamic power
- Phase and amplitude versus time (PAvT)
- Fast device tune
- IQ capture

Accessories

- E1987A fast switching mobile test application
- E6568C wireless test manager – automation test software for UMTS devices

Ordering Information

E1968A GSM/GPRS mobile test application

- E1968A-101 GSM functionality
- E1968A-102 GPRS functionality
- E1968A-103 EGPRS functionality
- E1968A-104 EDGE evolution functionality
- E1968A-201 GSM and GPRS functionality
- E1968A-202 GSM, GPRS, and EGPRS functionality
- E1968A-406 VAMOS
- E1968A-408 enhanced audio
- E1968A-409 SMS
- E1968A-410 EGPRS phase and amplitude versus time functionality
- E1968A-411 IQ capture
- E1968A-419 mobile calculated BER
- E1968A-431 Class 45
- E1999A-202 fast device tune
- E1999A-206 single channel GPS source
- E1999A-301 PESQ measurement

For detailed configuration information, refer to the 8960 configuration guide (5968-7873E) at www.agilent.com/find/8960config

Web Link

- www.agilent.com/find/E1968A
- www.agilent.com/find/E1987A
- www.agilent.com/find/E6568C

- Supports W-CDMA/HSPA RB test mode call processing and FDD test mode providing flexibility in UE connectivity
- Supports HSPA+ for up to 21 Mbps DL and 11.5 Mbps UL
- In-call system handover from W-CDMA to GSM – providing the fastest UMTS production
- Fast and accurate W-CDMA/HSPA TX/RX measurements in compliance with 3GPP TS34.121
- Faster calibration capability with the Fast Device Tune application – support of simultaneous transmitter and receiver calibration
- Frequency support for Bands I – XIV
- Full support of AMR/WB-AMR real-time vocoder, DAI, as well as PESQ objective MOS score testing for voice vocoder
- FM source and single channel GPS source for calibration of UE's built-in FM and GPS receivers
- One-box video loopback test and 2-box end-to-end video test with selected options

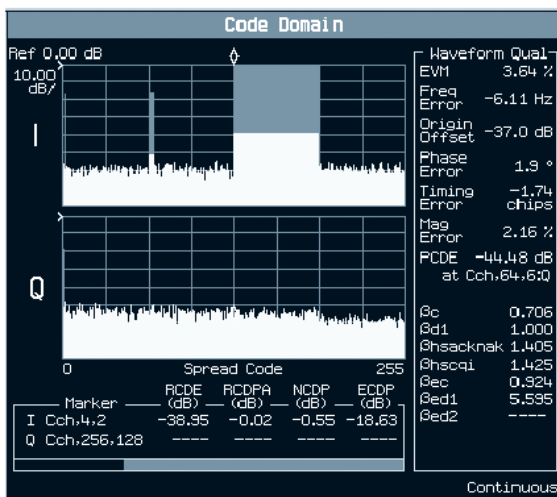

The Agilent E1963A W-CDMA/HSPA mobile test application, which runs on the industry standard 8960 (E5515C) wireless communications test set, delivers comprehensive call processing and RF parametric test capabilities to verify the performance of your W-CDMA, HSDPA, HSUPA, and HSPA+ capable mobile devices. When used with the Agilent GSM/GPRS/EGPRS applications, this solution delivers a complete and integrated UMTS test solution in a single box.

The E1963A with HSPA options provides the most complete test functionality for TS34.121 Section 5 and 6 tests. This gives design and manufacturing test engineers flexibility in creating test plans and the assurance that designs meet technology standards.

The fast device tune measurement (E1999A-202) provides simultaneously calibrating your device's transmitter (Tx) output power and receiver (Rx) input level across level and frequency. FM radio source, a single channel GPS source (E1999A-206) and PESQ measurement (E1999A-301) are also added into the test box for FM radio receiver calibration, GPS receiver calibration and audio quality test without the need of an external audio analyzer. This fast, one-box approach simplifies your production process and increase your production line effectiveness.

Specifications

Tx measurements

- Thermal power
- Channel power
- Adjacent channel leakage ratio
- Waveform quality
- Spectrum emission mask
- Phase discontinuity
- Inner loop power
- Occupied bandwidth
- Code domain power
- IQ tuning
- PRACH Tx on/off power
- Dynamic power analysis
- Tx dynamic power
- Spectrum monitor

Rx measurements

- Loopback BER
- BLER on DPCH (W-CDMA)
- HBLER on HS-DPCCH (HSDPA)

Accessories

E1987A fast switching mobile test application

E6568C wireless test manager – automation test software for UMTS devices

Ordering Information

E1963A W-CDMA mobile test application

E1963A-401 end-to-end video

E1963A-402 video loopback

E1963A-403 HSDPA test modes

E1963A-405 HSDPA 14.4 Mbps test mode

E1963A-408 enhanced audio (real-time vocoder, WB-AMR, DAI)

E1963A-409 Adv. SMS

E1963A-413 HSUPA test modes

E1963A-423 HSPA+ test modes

E1999A-202 enhanced fast device tune measurement

E1999A-206 single channel GPS source

E1999A-301 PESQ measurement

For detailed configuration information, refer to the 8960 configuration guide (5968-7873E) at www.agilent.com/find/8960config

Web Link

www.agilent.com/find/E1963A

www.agilent.com/find/E1987A

www.agilent.com/find/E6568C

E1966A
E1976A

- **First to market one box tester to support 1xEV-DO Release 0, Release A and Release B call processing**
- **Support FTAP/RTAP, FETAP/RETAP and FMCTAP/RMCTAP call processing for accurate Tx/Rx parametric testing of Release 0/A/B wireless terminals**
- **Support Release B multi-carrier and optional DRC (including 64QAM) for up to 4.9 Mbps (with one box) or 14.7 Mbps (with three boxes) forward link data rate**
- **Support Release B multi-carrier physical layer testing with one test set in factory test mode**
- **Support all commercialized bands (bands 0, 1, 3, 4, 5, 6, 7, 10, 11, 12, 14, 15, 18, and 19)**
- **Support single channel GPS source for calibration of AT's built-in GPS receiver**
- **Other flexible options for fading, multi-unit synchronization, protocol logging for wireless terminal design and verification**

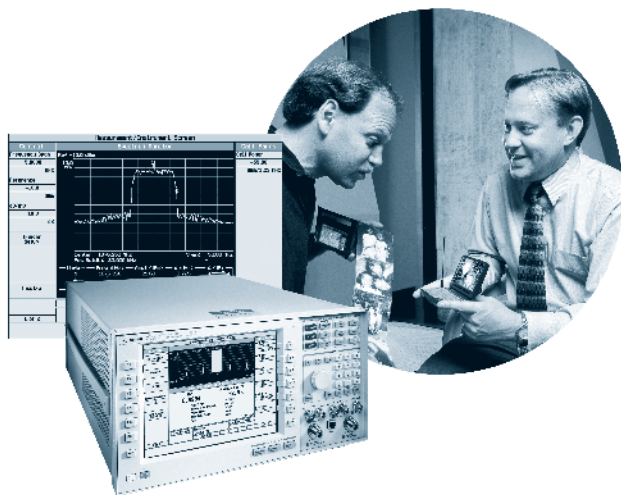

As the first one box test solution to support 1xEV-DO Release A and B, the Agilent E1966A 1xEV-DO test application in conjunction with the 8960 (E5515C) test set delivers comprehensive call processing and RF parametric test capability to verify the performance of your 1xEV-DO wireless access terminals, allowing physical channel testing at the highest data rates. The E1966A is designed for manufacturing, as well as developers and designers of leading-edge 1xEV-DO wireless access terminals (ATs).

The E1966A is the first to market with support for 1xEV-DO Rel B MCTAP and Optional DRC (including 64QAM). This functionality provides R&D engineers with standardized RF parametric tests for Rel B, ensuring that components are designed to handle the more stringent modulation requirements. Manufacturers can easily expand their existing 1xEV-DO production tests to include Rel B.

The E1976A 1xEV-DO factory test mode test application, which is a subset of the E1966A, is developed for R&D engineers and production test engineers to test the wireless access terminal's physical channel performance in factory test mode, rather than call processing. The test requires external serial port control of the mobile device. The E1976A meets the needs of mobile manufacturers with higher test speed and lower cost.

Based on the high performance E5515C test set, you gain the additional benefits of extremely fast measurement speed, ease of programming, accuracy, reliability, and worldwide service and support. These proven features help you shorten test development time, increase throughput, and minimize support costs. Agilent will help you protect your investment by meeting your test needs now and into the future.

Specifications

Tx measurements

- Average power
- Channel power
- Code domain power
- Access probe power
- Modulation quality
- Time response of open loop power
- Spectrum monitor
- Tx spurious emissions
- Tx dynamic power
- Fast device tune (optional)

Rx measurements

- FTAP/FETAP/FMCTAP loopback
- Dynamic range
- Sensitivity
- PER with AWGN
- Data rate control performance

Accessories

E1987A fast switching mobile test application

E6567C wireless test manager – automation test software for Cdma2000/1xEV-DO devices

Ordering Information

E1966A 1xEV-DO terminal test application

E1966A-102 1xEV-DO Rel A and B

E1966A-103 1xEV-DO multicarrier

E1966A-104 Rel B Optional DRC

E1966A-405 1xEV-DO digital bus (fading)

E1966A-406 1xEV-DO multi-unit sync

E1966A-407 1xEV-DO protocol logging

E1976A 1xEV-DO factory test mode test application

E1976A-102 1xEV-DO Rel A and B FTM

E1999A-202 enhanced fast device tune measurement

E1999A-206 single channel GPS source

For detailed configuration information, refer to the 8960 configuration guide (5968-7873E) at www.agilent.com/find/8960config

Web Link

www.agilent.com/find/E1966A

www.agilent.com/find/E1976A

www.agilent.com/find/E1987A

www.agilent.com/find/E6567C

- First to market to support cdma2000 1x Advanced call processing and related RF measurements
- First to market to support cdma2000 Release A protocol support along with the new F-BCCCH/F-CCCH and R-EACH channels
- Supports all of the service Options (1, 2, 3, 6, 9, 14, 17, 32, 33, 55, 68, 70 and 32768)
- Supports all commercialized bands (0, 1, 3, 4, 5, 6, 7, 10, 11, 12, 14, 15, 18 and 19) and other potential bands (2, 8, 9, 13, 16, 17)
- Flexible cdma2000 and IS-95 forward-link emulation used in R&D and product-test applications
- Fast and comprehensive cdma2000/IS-95/AMPS Tx/Rx measurements
- Fast calibration of Tx/Rx simultaneously with Fast Device Tune measurement
- Objective MOS score testing for vocoder speech quality with PESQ measurement
- FM source and single channel GPS source for calibration of UE's built-in FM and GPS receivers
- Other flexible options for fading, multi-unit synchronization, protocol logging, authentication and SMS features for mobile design and verification

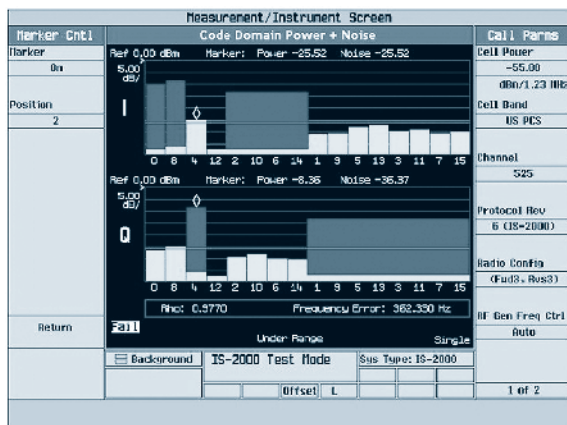

The Agilent E1962B cdma2000 mobile test application, which runs on the industry standard 8960 Series 10 (E5515C) wireless communications test set, delivers comprehensive call processing and RF parametric test capability to verify the performance of your cdma2000/IS-95/AMPS tri-mode wireless devices. The E1962B is developed for the needs of high-volume manufacturing, wireless RF device development, and service and repair.

As the first one box tester to support cdma2000 1x Advanced, the functionality helps R&D engineers and manufacturers verify that 1x advanced capable devices can handle smart blanking, frame early termination, slower reverse power control, and conform to the new RF parametric requirements.

The fully-coded IS-2000 forward-link emulation supports radio configurations 1 through 5 and all supplemental channel data rates associated with those configurations. Comprehensive signal generation capabilities include all applicable CDMA channels, modulation, and an AWGN source. Flexible user control of the forward link emulation is provided through easy-to-use front panel control and remote GPIB.

Specifications

CDMA Tx measurements

- Maximum power
- Minimum power
- Multi-coded waveform quality
- Open loop power accuracy
- Open loop power calibration
- Access probe power
- Code domain power
- Gated power
- Code channel timing and phase
- Spurious emissions
- Time response of open loop
- Tx dynamic power
- Spectrum monitor

CDMA Rx measurements

- Fundamental/traffic channel sensitivity
- Supplemental channel sensitivity
- Dynamic range
- Demodulation with AWGN

AMPS Tx measurements

- RF power output
- RF frequency and frequency error
- FM deviation and distortion
- FM modulation limiting
- Audio frequency response
- Audio distortion
- FM hum and noise
- SAT deviation and frequency error
- Compressor response
- Signaling tone frequency and deviation (Option E1962B-402)
- DTMF symbol, frequency, and deviation (Option E1962B-402)
- Wideband data deviation (Option E1962B-402)

AMPS Rx measurements

- SINAD
- Audio frequency response
- Audio distortion
- FM hum and noise
- Expander response

Accessories

E1987A fast switching mobile test application

E6567C wireless test manager – automation test software for Cdma2000/1xEV-DO devices

Ordering Information

E1962B cdma2000/IS-95/AMPS mobile test application

E1962B-401 CDMA2000 Rel A new control channels

E1962B-402 advanced AMPS measurements

E1962B-403 CDMA2000 authentication

E1962B-405 CDMA2000 digital bus (fading)

E1962B-406 CDMA2000 multi-unit sync

E1962B-407 CDMA2000 protocol logging

E1962B-409 CDMA2000 SMS

E1962B-410 cdma2000 1xAdvanced

E1999A-202 enhanced fast device tune measurement

E1999A-206 single channel GPS source

E1999A-301 PESQ measurement

For detailed configuration information, refer to the 8960 configuration guide (5968-7873E) at www.agilent.com/find/8960config

Web Link

www.agilent.com/find/E1962B

www.agilent.com/find/E1987A

www.agilent.com/find/E6567C

E1991B
E1993A
E1996A

- **Ordering convenience of one model number, providing a suite of test application formats for the 8960 Series 10 test set at a significant cost savings over the purchase of individual test applications**
- **Test applications included in the E1991B: E1962B (cdma2000/IS-95/AMPS), E1963A (W-CDMA), E1966A (1xEV-DO), E1968A (GSM, GPRS, EGPRS), E1961A (AMPS/IS-136), and E1987A for fast switching; other formats such as HSPA, E-EDGE, 1xEV-DO Rel A and Rel B, cdma2000 1x Advanced can be added at additional charge**
- **Test applications included in the E1993A: E1963A (W-CDMA), E1968A (GSM, GPRS, EGPRS), and E1987A for fast switching; other formats such as HSPA, E-EDGE can be added at additional charge**
- **Test applications included in the E1996A: E1962B (cdma2000/IS-95/AMPS), E1966A (1xEV-DO), and E1987A for fast switching; other formats such as 1xEV-DO Rel A and Rel B, cdma2000 1x Advanced can be added at additional charge**

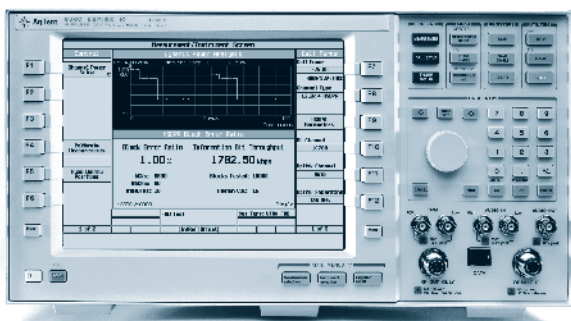

The Agilent E1991B test application suite for the 8960 Series 10 test set delivers the most popular wireless formats in one easy-to-order model number, providing the most cost-effective way to purchase multiple test applications needed to test today's multi-format wireless devices.

The Agilent E1993A UMTS test application suite for the 8960 Series 10 test set delivers the wireless formats needed to test UMTS devices in one easy-to-order model number. The E1993A provides the most cost-effective way to purchase multiple test applications to test UMTS devices with GSM, GPRS, EGPRS, and W-CDMA formats. HSPA can be added for an additional charge.

The Agilent E1996A cdma2000/1xEV-DO test application suite for the 8960 Series 10 test set delivers the wireless formats needed to test cdma2000 and 1xEV-DO devices in one easy-to-order model number. The E1996A provides the most cost-effective way to purchase multiple test applications to test wireless devices with cdma2000/IS-95/AMPS, and 1xEV-DO formats.

Get the proven benefits of the industry-standard Agilent 8960 test set. Because these test solutions are based on the high-performance 8960 Series 10 test set, you gain the additional benefits of extremely fast measurement speed, accuracy, reliability, and worldwide service and support. The multi-format capabilities of the 8960 can reduce your costs by offering format-flexible manufacturing with a single test set. These proven features help you shorten development time, increase throughput, and minimize support costs.

Specifications

- The E1991B mobile test application suite combines the measurements and features from the following into a single model number: E1962B cdma2000/IS-95/AMPS, E1963A W-CDMA, E1966A 1xEV-DO, E1968A GSM/GPRS/EGPRS, and the E1987A fast switching mobile test application which allows fast switching across all test applications
- The E1993A UMTS test application suite combines the measurements and features from the following into a single model number: E1963A W-CDMA, E1968A GSM/GPRS/EGPRS, and the E1987A fast switching mobile test application which allows fast switching across the test applications
- The E1996A cdma2000/1xEV-DO TA suite combines the measurements and features from the following into a single model number: E1962B cdma2000/IS-95/AMPS, E1966A 1xEV-DO, and the E1987A fast switching mobile test application which allows fast switching across the test applications

Accessories

E6569C wireless test manager suite

Ordering Information

E1991B mobile test application suite

E1993A UMTS test application suite

E1996A cdma2000/1xEV-DO TA suite

All options under the ordering information of the E1962B, E1963A, E1966A, and E1968A

For detailed configuration information, refer to the 8960 configuration guide (5968-7873E) at www.agilent.com/find/8960config

Web Link

www.agilent.com/find/E1991B

www.agilent.com/find/E1993A

www.agilent.com/find/E1996A

www.agilent.com/find/E6569C

- Provides fast switching between GSM, GPRS, EGPRS, cdma2000, IS-95, W-CDMA, HSPA 1xEV-DO, 1xEV-DO Rel A and Rel B
- Switching between wireless formats in two to four seconds
- Fast, high-quality transmitter and receiver measurements across the most popular wireless formats. For more information see individual format applications
- Allows configuration of idle applications while testing another format an active application providing further test time reductions

New multi-format wireless devices require test equipment that provides complete wireless technology format flexibility and the ability to switch between those formats fast. The Agilent E1987A is a single application for fast switching across all 8960 test applications for multi-format device test.

The E1987A fast switching TA runs on the Agilent 8960 Series 10 wireless set and is designed to minimize test setup, significantly reduce test times, and help you meet your customer demands for multi-format wireless devices. Using the E1987A fast switching TA, you can minimize setup time when reconfiguring production lines by switching between test applications in less than two to four seconds!

The E1987A offers an extensive list of transmitter and receiver tests for the most popular 2G/3G/3.5G wireless mobile formats. They support full signaling (active mode), limited signaling (test mode), and CW modes. For details of the test capabilities in a specific format, refer to the application that supports that format: E1968A for GSM, GPRS and EGPRS; E1962B for cdma2000, IS-95 and AMPS; E1963A for W-CDMA; and E1966A for 1xEV-DO.

Get the Proven Benefits of the Agilent 8960 Test Set

Because these test solutions are based on the high-performance 8960 Series 10 test set, you gain the additional benefits of fast measurement speed, high quality measurements, ease of programming, accuracy, and worldwide service and support. The multi-format capabilities of the 8960 can reduce your costs by offering format-flexible manufacturing with a single test set. These features help you shorten test development time, increase throughput, guarantee device quality, and minimize support costs.

Specifications

The E1987A does not include the individual test applications, only the ability to fast switch between applications when they are installed concurrently. See the specifications of the individual applications.

Accessories

E6567C, or **E6568C**, or **E6569C** wireless test manager software.

Ordering Information

E1987A fast switching test application

The E1987A does not include the individual test applications, only the ability to fast switch between applications when they are installed concurrently. Require the purchase of two or more individual mobile test applications along with the E1987A in order to fast switch between them (E1961A, E1962B, E1963A, E1966A, E1968A).

For detailed configuration information, refer to the 8960 configuration guide (5968-7873E) at www.agilent.com/find/8960config

Web Link

www.agilent.com/find/E1987A
www.agilent.com/find/E6567C
www.agilent.com/find/E6568C
www.agilent.com/find/E6569C

E1969A

- Complete TD-SCDMA/GSM test solution integrated into a single test set
- TD-SCDMA real-time downlink source
- Fast switch (TD-SCDMA & GSM/GPRS/EGPRS)
- Fast and accurate TX/RX measurements in compliance with 3GPP TS34.122
- Frequency support for Bands A and F
- User-configurable fixed reference channel (FRC) enable HSDPA data throughput testing in radio bearer (RB) test mode
- Uplink closed-loop power control algorithm and step size can now be modified without losing connection in order to perform a handover in the physical channel domain
- CW and FM signal sources
- Single channel GPS source

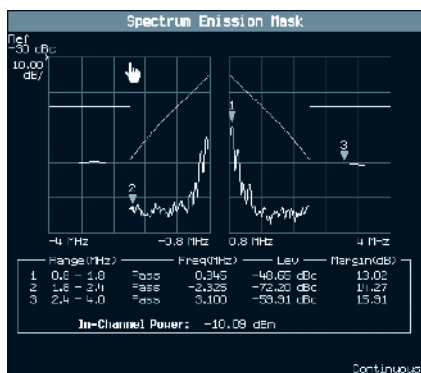
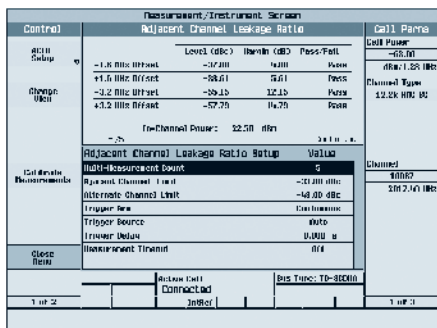

With E1969A TD-SCDMA_GSM fast switch test application, Agilent's 8960 (E5515C) test set covers TD-SCDMA user equipment (UE) test based on 3GPP standards. On a single hardware platform, the E5515C, all 2G and 3G formats are supported with corresponding licenses: GSM/GPRS/EGPRS, WCDMA/HSDPA/HSUPA, HSPA+, TD-SCDMA, CDMA2000, 1xEVDO rev A/rev B.

E1969A-101 is designed to be used under non-signaling mode without an integrated TD-SCDMA protocol stack while E1969A-201 supports signaling mode.

E1969A-403 TD-HSDPA test modes for the E1969A enable fast production test by providing both TD-SCDMA and HSDPA test results from a single call connection. Maximize your production throughput with Best In Class suite of fast and accurate TX/RX measurements in compliance with 3GPP TS34.122.

Specifications

Tx measurements

- Channel power
- Occupied bandwidth (OBW)
- Transmit on/off time mask (TOOP)
- Waveform quality
 - Error vector magnitude (EVM)
 - Frequency error
 - Peak code domain error (PCDE)
- Adjacent channel leakage ratio (ACLR)
- Spectrum emission mask (SEM)
- Closed loop power control (CLPC)
- Open loop power control (OLPC)
- Dynamic power (DPOW)
- Spectrum monitor

Rx measurements

- Single-ended BER
- Loopback BER
- BLER on DPCH (TD-SCDMA)
- HBLER on HS-DSCH (HSDPA)

Call processing

- Test control call processing for RMC
- Call control call processing for voice echo
- UE measurement report
- Reduce signaling TD-SCDMA test mode
- Location update
- MS and BS originate/release
- UARFCN hard handoff
- TD-SCDMA to GSM system handover
- SC to MC handover
- Loopback modes 1 and 2
- In-call spectrum analysis
- HSDPA user-defined downlink

Audio measurements

- Frequency stability
- Audio level
- SINAD
- Distortion
- Audio frequency

Accessories

E1968A GSM/GPRS/EGPRS mobile test application

Ordering Information

E1969A TD-SCDMA_GSM fast switch test application

E1969A-101 TD-SCDMA non signaling test mode

E1969A-201 TD-SCDMA signaling mode

E1969A-403 TD-HSDPA

E1999A-206 single Ch GPS source

For detailed configuration information, refer to the 8960 configuration guide (5968-7873E) at www.agilent.com/find/8960config

Web Link

www.agilent.com/find/E1969A

www.agilent.com/find/E1968A

- Test multiple wireless connectivity technologies with one test platform
- Increase manufacturing throughput with fast, accurate measurements
- Repeatable measurement results from development through to production
- Use with N4011A MIMO/multi-port adapter for testing WLAN MIMO devices and modules
- Use with the 89601A vector signal analyzer software or N4018C/19C *Bluetooth*/WLAN wireless test manager software to make a broad range of measurements for evaluating wireless formats in the 2.4 or 5 GHz bands
- The N4010A covers *Bluetooth*, WLAN, and ZigBee



Gain the flexibility to measure the latest emerging wireless standards and increase test efficiency with the N4010A wireless connectivity test set.

The N4010A is a versatile multi-format wireless connectivity test solution that you can configure for your particular *Bluetooth*, ZigBee, Wireless LAN (WLAN) 802.11a, b, g and 802.11n MIMO applications in R&D, integration and verification, or manufacturing.

Additional Flexibility

- For MIMO device and module testing use with the N4011A MIMO/multi-port adapter
- For *Bluetooth* analysis use with the N4017A *Bluetooth* graphical measurement applications
- Test automation software simplifies test sequence creation and optimization with the N4018C/19C *Bluetooth* and WLAN wireless test manager
- For general signal analysis use with the 89601A vector signal analysis software

Specifications

Detailed specifications are found in the N4010A data sheet (5989-4035EN) for the individual technology options

Accessories

- N4011A** MIMO/multi-port adapter
- N4017A** *Bluetooth* graphical measurement application
- N4018C** *Bluetooth* and WLAN wireless test manager (run-time license and software)
- N4019C** *Bluetooth* and WLAN wireless test manager (development license and software)
- N7306A** chipset software for Broadcom WLAN/*Bluetooth* devices and modules
- N7307A** chipset software for TI WLAN/*Bluetooth* devices and modules

For more detailed configuration information, refer to the N4010A wireless connectivity test set configuration guide (5989-3486EN) found in the selection and configuration section of the product library at www.agilent.com/find/N4010A

Ordering Information

- N4010A** wireless connectivity test set
 - N4010A-101** *Bluetooth*
 - N4010A-102** 2.4 GHz wireless LAN Tx/Rx analysis (for WLAN and ZigBee)
 - N4010A-103** 2.4 GHz/5 GHz wireless LAN Tx/Rx analysis (for WLAN)
 - N4010A-104** fully flexible Arb
 - N4010A-105** *Bluetooth* EDR – transmit and receive
 - N4010A-106** *Bluetooth* EDR – transmit
 - N4010A-107** *Bluetooth* EDR link plus measurements
 - N4010A-108** 802.11n MIMO modulation analysis
 - N4010A-112** *Bluetooth* headset profile
 - N4010A-113** *Bluetooth* audio generation and analysis
 - N4010A-204** signal studio license
- N4011A** MIMO/multi-port adapter
- N7306A-1** chipset software for Broadcom BCM4325
- N7306A-3** chipset software for Broadcom BCM4329
- N7307A-1** chipset software for TI WL1271/3

Web Link

- www.agilent.com/find/N4010A
- www.agilent.com/find/N4011A
- www.agilent.com/find/N4017A
- www.agilent.com/find/N4018C
- www.agilent.com/find/N4019C
- www.agilent.com/find/N7306A
- www.agilent.com/find/N7307A

N6050A-7FP
N6051A-1FP
N6052A-1FP
N6061A-1TP
N6062A-1TP
N6072A
N6075A
N6431A
E6621A

- **Highly flexible base station emulation for LTE UE test**
- **LTE RF measurements based on 3GPP 36.521 in either UE test mode or end to end data connection for full characterization of both the Rx and Tx paths**
- **Protocol functional test**
- **High data rate throughput test up to LTE cat 3 downlink – 102.05 Mbps**
- **Transmission modes 1-4, SISO, Tx diversity, open loop and closed loop MIMO**
- **Optional LTE message editor for increased protocol test flexibility**
- **Optional LTE protocol logging and analysis to debug and analyse connection and data handling issues**
- **Extendible to signaling conformance test with industry standard validated TTCN test cases**

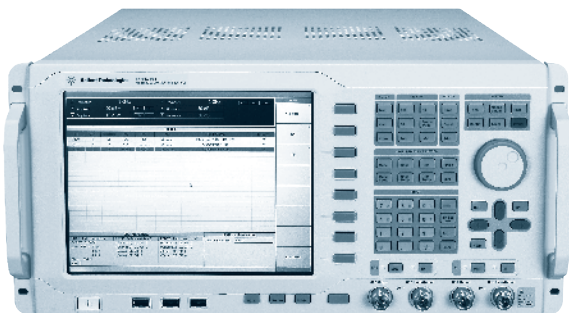

Agilent PXT, E6621A

The E6621A PXT instrument represents a significant breakthrough in LTE UE testing. It incorporates flexible base station/network emulation and RF parametric tests into one integrated unit and extends Agilent's unmatched portfolio of LTE test solutions for development and verification. The E6621A PXT hardware is configurable with a number of advanced test and analysis software options.

N6051A LTE RF Parametric Test with Test Mode Signaling

The PXT includes a suite of LTE RF measurements that may be used for characterization, calibration, and verification purposes, available while on a connection, ideal for the RF engineer.

N6052A LTE Functional and Application Test

With realistic base station/network emulation, the PXT LTE test set offers a controlled environment which can be used to verify network attach, idle and connected mode operation and functional performance such as throughput. The PXT provides maximum flexibility to configure a range of connection and network parameters so enabling test, stress, and debug of the protocol and data handling capabilities of designs including DL 2x2 MIMO and handovers (from 2011).

N6061A LTE Protocol Logging and Analysis

LTE protocol logging and analysis are essential tools for debugging interoperability issues inevitable with evolving radio technologies such as LTE. Even relatively simple tests such as UE attach can become frustrating without the tools to adequately debug and resolve issues.

N6062A LTE Message Editor

LTE message editor is a highly flexible tool for configurability of layer 3 messages (RRC and NAS). It provides detailed parameter control offering far more flexibility than a normal wireless communications test set.

N6050AS LTE Mobile Test Software – Software and Technical Support Contract

This product entitles the user to software updates and technical support for the E6621A PXT firmware N6050A, N6051A, N6052A LTE mobile test software, N6061A LTE protocol logging and analysis software and the N6062A LTE message editor software.

Signaling Conformance Test

In addition to a stand-alone wireless communications test set, the PXT is also the basis for Agilent LTE signaling conformance and development solution. This solution boasts many GCF validated test cases with many more in progress, industry standard Tworkbench GUI for test execution and custom TTCN-3 test case development.

Ordering Information

- E6621A** PXT wireless communications test set
 - E6621A-503** frequency range from 500 MHz to 3.0 GHz
 - E6621A-506** frequency range from 500 MHz to 6.0 GHz
 - E6621A-2D2** downlink 2x2 MIMO (required)
 - E6621A-BB1** enhanced baseband processing (adds hardware required for 2-cell and higher UL data throughput)
 - E6621A-0PC** desktop PC, high performance (for optional N6061A, N6062A)
- N6050A** LTE mobile test software
 - N6050A-7FP** LTE FDD base station emulation (required)
 - N6050AS-1SY** LTE mobile test software – 1 year STSC (required)
 - Extend the term of the contract to:
 - N6050AS-2SY** LTE mobile test software – 2 year STSC
 - N6050AS-3SY** LTE mobile test software – 3 year STSC
 - N6051A** LTE parametric test with test mode signaling
 - N6051A-1FP** LTE RF Tx and Rx measurements
 - N6052A** LTE functional and application test
 - N6052A-1FP** LTE enhanced BSE and IP data test
 - N6061A** protocol logging and analysis
 - N6061A-1TP** LTE protocol logging and analysis
 - N6062A** protocol message editor
 - N6062A-1TP** LTE message editor
 - N6072A** LTE signaling conformance adapters and test cases
 - N6072A-1TP** LTE signaling conformance batch A test cases and TTCN test adaptor
 - N6072AS-1SY** LTE signaling conformance – 1 year STSC
 - Extend the term of the contract to:
 - N6072AS-2SY** LTE signaling conformance – 2 year STSC
 - N6072AS-3SY** LTE signaling conformance – 3 year STSC
 - N6431A-2FP** TTCN-3 environment, developer
 - N6075A** LTE signaling conformance test suite, includes N6431A-2FP, N6072A-1TP, N6061A-1TP, N6072AS-1SY and PS-S20-01 startup assistance

Web Link

- www.agilent.com/find/pxt
- www.agilent.com/find/e6621a
- www.agilent.com/find/lte

- **Speed** – executes test plans at the highest speed with one-button measurements and a highly flexible test sequencer
- **Multiple formats** – tests new and existing radio formats including LTE, HSPA+, and *Bluetooth*
- **Lower cost** – reduces your initial capital investment with an architecture optimized for non-signaling test
- **Flexibility** – works with your device's built-in test modes providing sequencing over a wide frequency range
- **Accuracy** – delivers high first pass yields with accurate, repeatable results and measurement traceability
- **Future-proof** – preserves your investment with an upgradeable processor, superior hardware and software scalability for technology advances



Agilent EXT, E6607A

The Best One-Box Test Set for Non-signaling Test in Cellular and Wireless Device Manufacturing

The Agilent E6607A EXT wireless communications test set integrates an innovative test sequencer, vector signal analyzer (VSA), vector signal generator (VSG), and multi-port RF input/output hardware for non-signaling test in cellular and wireless device manufacturing all in a single box.

Fast, standards-compliant, measurements and modulation analysis capabilities are provided by Agilent's U90XXA measurement applications, designed specifically for the EXT based on the proven measurement algorithms of the Agilent X-Series signal analyzers. Advanced multi-technology signal creation is available using the industry standard signal studio software for base station downlink simulation.

The EXT works in conjunction with chipset test modes using fast measurements and flexible sequencer techniques to speed calibration and verification of your devices and modules. When you are ready to move to non-signaling1 test, the EXT will take you there, easily and efficiently.

Key Features of the EXT

- **Speed** – executes test plans at the highest speed with one-button measurements and a highly flexible test sequencer
- **Multiple formats** – tests new and existing radio formats including LTE, HSPA+, and *Bluetooth*
- **Lower cost** – reduces your initial capital investment with an architecture optimized for non-signaling test
- **Flexibility** – works with your device's built-in test modes providing sequencing over a wide frequency range
- **Accuracy** – delivers high first pass yields with accurate, repeatable results and measurement traceability
- **Future-proof** – preserves your investment with an upgradeable processor, superior hardware and software scalability for technology advances

Increased Throughput

The EXT provides fast results for increased throughput in high volume production:

- Flexible test sequencer uses high speed single acquisition, multiple measurement techniques for faster analysis
- Fast frequency and amplitude switching help speed device tuning
- Deep measurement capture and long arbitrary waveform playback handle complex transmission scenarios
- Overlapped acquisitions help reduce the overall test time from initiation to result
- Measurement computation starts ahead of data capture completion
- Flexible 4-port RFIO enables innovative multi-device insertion configuration

Lower Cost of Test

The EXT has just the capability you need to help reduce manufacturing costs in today's competitive manufacturing environment. It's optimized for more economical, non-signaling test. All major cellular and complementary radio formats are supported in a single box – there's no need to purchase additional instruments.

As technology changes, simply add new software measurements to fit your production needs. Flexible licenses (temporary, permanent, or transportable) support your budget so that you buy just what you need, when you need it – installation is easy.

Ordering Information

Broad frequency and format coverage

Frequency ranges

E6607A-503 frequency range 10 MHz to 3.6 GHz

E6607A-506 frequency range 10 MHz to 6.0 GHz

Measurement and signal studio applications

Several licensing options such as fixed perpetual, time-based, and transportable perpetual licenses are available.

U9063A analog demodulation measurement application

U9071A GSM/EDGE measurement application

U9071A EDGE evolution measurement application

U9072A cdma2000 measurement application

U9073A W-CDMA measurement application

U9073A HSDPA/HSUPA measurement application

U9073A HSPA+ measurement application

U9076A 1xEV-DO measurement application

U9080A LTE measurement application

U9081A *Bluetooth* EDR and ULP measurement application

N7600B signal studio for 3GPP W-CDMA FDD

N7601B signal studio for 3GPP2 CDMA

N7602B signal studio for GSM/EDGE

N7606B signal studio for *Bluetooth*

N7611B signal studio for broadcast radio

N7616B signal studio for T-DMB

N7617B signal studio for 802.11 WLAN

N7624B signal studio for 3GPP LTE

Web Link

www.agilent.com/find/ext

www.agilent.com/find/E6607A

E6651A

The Mobile WiMAX test set and associated software products provide a comprehensive set of tools for design verification, conformance and manufacturing test

- WiMAX base station emulation
- Multi-profile support
- Physical layer measurement suite
- Functional test
- Protocol test
- TTCN-3 scripting



The E6651A represents a significant breakthrough in Mobile WiMAX testing. It incorporates flexible base station emulation, RF parametric tests and a scripting interface into one integrated unit and extends Agilent's unmatched portfolio of WiMAX test solutions for development, verification and manufacturing customers.

The Agilent E6651A provides RF signal generation and signal analysis capability up to 6 GHz and includes a full suite of high-speed, RF measurements for characterization, calibration and verification purposes.

The Mobile WiMAX test set can be extended to enable protocol interoperability and application testing. With realistic base station emulation the test set offers a controlled environment, with flexibility to configure a wide range of network parameters in which you may test, stress and debug the protocol and data handling capabilities of your design.

The E6651A also offers a TTCN-3 protocol scripting interface. This can be used in conjunction with a PC based PCT (protocol conformance test) application for both WiMAX Forum® validated conformance testing and for user generated script based testing during development.

With this exciting new product, Agilent will help you get your designs to market faster and more efficiently, and will continue to provide comprehensive tools for all stages of your product lifecycle. For further WiMAX solutions see www.agilent.com/find/WiMAX

Features of emerging mobile devices are increasing in complexity and software content. The E6655A WiMAX lab application allows testing of emerging mobile devices in a realistic network environment to ensure the quality of your mobile equipment design. The WiMAX lab application allows you to do this – supporting real-time, end-to-end functional test of your WiMAX design. Features of the lab application include:

- Controlled network environment – no need to run tests on a live network
- Verify correct operation, stress test your WiMAX device by running multiple applications
- Configure key elements of MAC operation

Quickly collect and interpret wireless protocol messaging, verify functionality, and isolate and resolve protocol problems when developing mobile stations and applications with the N6421A WiMAX protocol logging and analysis software. Features include:

- Real-time logging and decodes of PHY and MAC layer protocol
- Post-capture analysis of protocol log files
- Log filtering makes it easy to sort through the huge volume of messaging to and from the WiMAX device

The Agilent N6422C WiMAX wireless test manager software provides ready-to-use tests, test plans, test sequencing, and menu-selectable hardware support for quick and easy automation of device calibration and test processes. An integrated test development wizard simplifies making software modifications adding user-defined tests. The test manager runs on a PC and supports Agilent test system hardware. Features of the WiMAX wireless test manager software include:

- Ready-to-use tests, test plans, and test sequencing
- Customize test steps and test parameters by using Wizards to reduce time on coding
- Results can be logged, compared, and post processed

Specifications

- Multi-profile support
- Frequency coverage to 6 GHz
- PHY measurements including timing, frequency, modulation, power, RSSI, PER, sensitivity
- Network entry testing
- Traffic connection establishment
- Data transfer
- Functional test
- Protocol logging
- TTCN-3 protocol test case support

Accessories

- E6655A** WiMAX lab application
- N6421A** WiMAX protocol logging and analysis
- N6422C** WiMAX wireless test manager
- N6430A** WiMAX protocol conformance test solutions

Ordering Information

- E6651A** mobile WiMAX test set
- E6651A-503** frequency range from 450 MHz to 2.7 GHz
- E6651A-506** frequency range from 450 MHz to 6 GHz

Web Link

www.agilent.com/find/E6651A

- Complete one-box transmitter and receiver test solution for mobile and Fixed WiMAX devices and modules – and now WLAN 802.11a, b, g and n measurements are also supported
- Fast, accurate and repeatable measurements for WLAN and WiMAX manufacturing test
- Superior measurement consistency through the product lifecycle from R&D to design verification to manufacturing using industry leading WLAN and WiMAX R&D test tool algorithms
- Simplify test development with easy-to-use graphical user interface and SCPI programming
- Frequency ranges: 1.765 to 1.815 GHz, 2.15 to 2.7 GHz, 3.3 to 3.8 GHz and 4.8 to 6.0 GHz
- Comprehensive connectivity: USB, 100baseT LAN and GPIB
- Use with the N7300 Series chipset software to provide control, calibration and test of WiMAX and WLAN devices and modules
- Software upgrades along with a flexible hardware structure protects your investment in the N8300A for future wireless networking applications

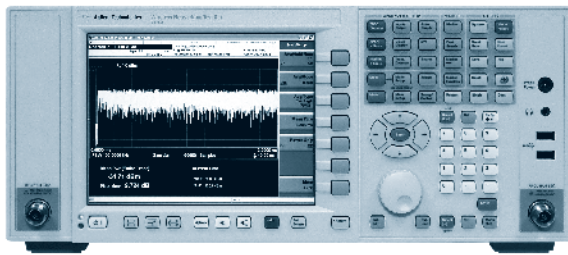

The N8300A is a one-box RF parametric test set targeting manufacturing and design engineers who need a standard-compliant 802.16d and/or a physical layer (PHY) test tool for fixed and Mobile WiMAX, and/or WLAN Tx and Rx applications. Based on an architecture comprising an integrated vector signal analyzer (VSA) and vector signal generator (VSG), the N8300A provides a graphical user interface, a SCPI interface and consistency of software and measurements with industry leading WiMAX R&D test tools that enables fast test development.

The new Option 404 (MIMO/multi-port connectivity) has broadcast mode, providing parallel, multiple device-under-test (DUT) receiver calibration and test. Broadcast mode can transmit the same signal from all four ports (RF In/Out 1 to 4) simultaneously, individually or any other permutation. Notably full high output power is always available on all ports under all permutations. This gives faster receiver calibration and test leading to the greatest device throughput.

Specifications

Detailed specifications are found in the specifications section of the product library at www.agilent.com/find/N8300A

Accessories

- N7300A** chipset software provides control, calibration and test of Beceem WiMAX devices and modules
- N7302A** chipset software provides control, calibration and test of Sequans WiMAX devices and modules
- N7304A** chipset software provides control, calibration and test of Altair WiMAX devices and modules
- N7306A** chipset software provides control, calibration and test of Broadcom WLAN/*Bluetooth* devices and modules
- N7307A** chipset software provides control, calibration and test of TI WLAN and *Bluetooth* devices and modules

Ordering Information

N8300A wireless networking test set

N8300A-404 MIMO/multi-port connectivity

N8300A-505 frequency range to 4.8 GHz

N8300A-506 frequency range to 6.0 GHz

N8300A-1CR rack slide kit

N8300A-KYB keyboard, USB

N8300A-MSE mouse, USB

N8300A-UK6 commercial calibration certificate with test data

The rack-mount kit and handle come as standard with all N8300A shipments

N6301A 802.16 OFDMA measurement application

N6301A-1FP 802.16 OFDMA measurement application – fixed perpetual license

N6301A-2FP 802.16 OFDM (fixed WiMAX) measurement application – fixed perpetual license

N6302A WLAN measurement applications

N6302A-1FP 802.11a, b, g and n WLAN measurement – fixed perpetual license

N6302A-2FP 802.11b, g WLAN measurement application – fixed perpetual license

N7300A Serials chipset software for WiMax/WLAN/*Bluetooth* test

N7300A-1 chipset software for Beceem BCS200/BCSM250/BCS5200

N7302A-1 chipset software for SQN1130 & MAX283x

N7302A-2 chipset software for SQN1130 & PM880x/885x

N7302A-3 chipset software for SQN1130 & SQN1140/5

N7304A-1 chipset software for ALT2150 & MAX2839

N7306A-1 chipset software for Broadcom BCM4325

N7306A-3 chipset software for Broadcom BCM4329

N7307A-1 chipset software for TI WL1271/3

Web Link

www.agilent.com/find/wimax

www.agilent.com/find/N8300A

GS-8800
N1960A

- Reduce costs and accelerate time to market
- Supports multi formats: GSM, GPRS, EGPRS, EGPRS2, W-CDMA, HSDPA, HSUPA, HSPA+, cdmaOne/cdma2000, 1xEV-DO, 1xEVDO-Rev A, 1xEVDO Rev B
- High speed measurement for pre-conformance test with accurate test results
- Extensibility and scalability
- Local delivery and global support

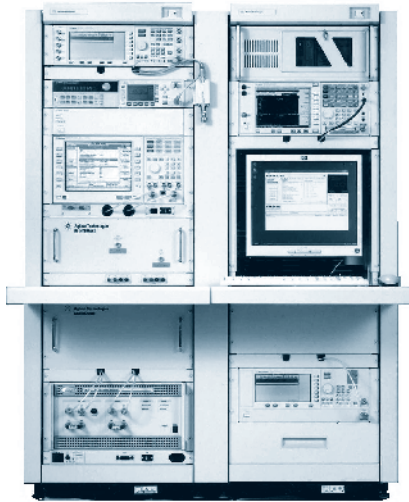

System Overview

The system is integrated in the rack (1.6 m x 2 racks or 2 m rack) with test equipment and software.

Base system:

- E5515C wireless test set
- E4445A spectrum analyzer
- E4438C ESG digital signal generator
- E8257D microwave signal generator
- 66319D power supply
- N1961A RF I/F
- N9370A switch driver
- E4418B power meter
- Industrial PC
- GS-8800 measurement software
- GS-8800 calibration software
- GS-8800 data viewer software

Optional:

- Fading simulator option
- N1962A GSM module option

System Concept

The Agilent N1960A GS-8800 is a multi-format RF design verification and conformance test system.

It is designed for mobile phone design verification and conformance testing.

The Agilent N1960A GS-8800 RF design verification system can help the product designer validate aspects of the design long before conformance testing is performed by test lab using Agilent N1960A GS-8800 RF conformance test system, thereby increasing the chances that the design will pass conformance test the first time which help to accelerate time-to-market.

The system is comprised of Agilent standard equipment and software. The system capabilities are augmented by configuring a RF interface module, which is optimized for the highest measurement accuracy possible. The RF Interface module handles all of the RF switching and conditioning. The software is made up of pre-defined tests that conform to the individual technology standard.

User Interface Screen

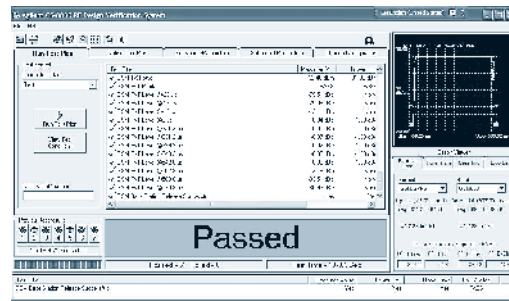

Example GS-8800 user interface screens

Key Features and Benefits

Reduce costs and accelerate time to market

Pre-Conformance test reduces capital cost, and you can validate your design before full conformance testing. The lower system price permits wider deployment.

Support multi-formats

The GS-8800 supports:

- GSM
- GPRS
- EGPRS
- EGPRS2
- cdmaOne
- cdma2000
- 1xEVDO
- 1xEVDO Rev. A
- 1xEVDO Rev. B
- W-CDMA
- HSDPA
- HSUPA
- HSPA+

Extensibility and scalability

The N1960A test systems can be easily scaled to include other radio technology formats on the same hardware platform by adding the necessary radio technology format software option. In addition, the N1960A design verification test systems can be scaled up to conformance test systems for conformance testing, or scaled down to the N8993A bench-top test systems to support manufacturing and quality assurance testing.

Accuracy and repeatability

N1960A test systems provide accurate measurements and repeatable results due to equipment stability and complete system calibration. They leverage the measurement speed, accuracy, and repeatability strengths of Agilent products; creating reliable, high performance results. The measurement steps are accurate and compliant to specification RF parametric testing.

Local delivery and global support

Agilent can deploy a system solution globally, which is verified to conform to your exact specifications. We then tailor a system support package for your local sites to achieve the best in responsiveness and communication.

Specifications

Description	Specification	Supported band
GSM/GPRS/EGPRS/EGPRS2	3GPP TS51.010-1	GSM 850, GSM 900, DCS 1800, PCS 1900
W-CDMA/HSDPA/HSUPA/HSPA+	3GPP TS34.121-1	Bands I to IX (Conformance test system support Band I, II, IV, V and VIII only)
cdmaOne/cdma2000	3GPP2 C.S0011	Band Class 0, 1, 3, 4, 6 and 15
1xEV-DO/1xEV-DO Rev. A/1xEV-DO Rev. B	3GPP2 C.S0033	Band Class 0, 1, 3, 4, 6

Ordering Information

N1960A GS-8800 design verification system

Contact Agilent Technologies to configure a customized test system.

Web Link

www.agilent.com/find/gs8800

- Entry-level and mid-range design verification systems for wireless handset R&D
- Support multiple formats: GSM, GPRS, EGPRS, W-CDMA, HSDPA, HSUPA, HSPA+, cdmaOne/cdma2000, 1xEV-DO, 1xEVDO-Rev A, TD-SCDMA
- High speed measurement for pre-conformance test with accurate test results
- Flexible scalability from N8993A GS-8800 Bench-top to N1960A GS-8800 GS-8800 design verification or conformance test system
- Accurate measurement with wide frequency range up to 13.5 GHz and wide dynamic range that compliant to international standards
- Automatic measurement using loop-back test protocol

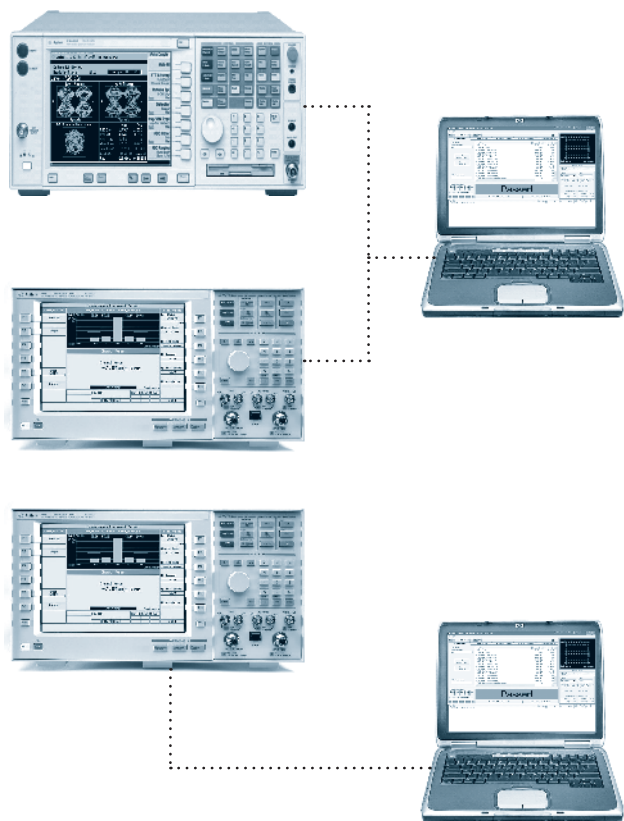

System Overview

Agilent N8993A GS-8800 bench-top RF design verification systems are part of the GS-8800 family that provide entry-level and mid-range platforms for wireless handset and designed to support multi-format RF. Agilent N8993A GS-8800 bench-top systems provide product designers with pre-conformance test coverage that help to ensure better results before their new wireless handset go into full conformance testing. This will in turn help customer to reduce their cost of design validation by increase the passing rate at the first time when undergoing a complete conformance testing. Normally a complete conformance testing is expensive and often iterative if no pre-conformance test.

System Structure

While all GS-8800 systems can help to reduce cost of design validation by ensuring better results when undergoing full conformance testing, the bench-top systems provide an alternative for users who are looking for an entry-level or a mid-range solution with good pre-conformance test coverage. N8993A GS-8800 bench-top system provides customer who wants a entry-level pre-conformance test solution with “just-enough” test coverage for pre-conformance testing. An easy and flexible upgrade path with GS-8800 family is possible with multiple RF formats, customer can choose to upgrade their N8993A GS-8800 bench-top to N1960A GS-8800 design verification or conformance test system.

Quick Reference Table for N8993A Hardware and System Component

System	Industrial PC	GS-8800 software	8960 Series 10 (E5515C)	E4445A spectrum analyzer	N5115B baseband studio for fading
N8993A-Sxx	•	•	•		
N8993A-SA1				•	
N8993A-FA1					•

Optional ‘add-on’ components include:

- 66319D power supply

Specifications

Description	Specification	Supported band
GSM/GPRS/EGPRS/EGPRS2	3GPP TS51.010-1	GSM 850, GSM 900, DCS 1800, PCS 1900
W-CDMA/HSDPA/HSUPA/HSPA+	3GPP TS34.121-1	Bands I to IX (conformance test system support Band I, II, IV, V and VIII only)
cdmaOne/cdma2000	3GPP2 C.S0011	Band Class 0, 1, 3, 4, 6 and 15
1xEV-DO/1xEV-DO Rev.A/1xEV-DO Rev.B	3GPP2 C.S0033	Band Class 0, 1, 3, 4, 6
TD_SCDMA	3GPP TS34.122	Band A and F

Ordering Information

N8993A GS-8800 Series (8960) wireless communication design verification (DV) bench-top systems
Contact Agilent Technologies to configure a customized test system.

Note: The test coverage of the denominator refers to the standard requirement of 3GPP. Please contact Agilent Technologies to obtain the detail test coverage for GS-8800 systems family.

Web Link

www.agilent.com/find/gs8800

GS-8800
N8993A

GS-8800
U1905A

- **Entry-level and mid-range LTE design verification systems**
- **Reduce costs and accelerate time to market**
Benchtop system reduces capital cost, and you can validate your design before full conformance testing. The lower system price permits wider deployment
- **Extensibility and scalability**
- **The GS-8800 scales from small system to full system by protect and leverage customers existing investments**
High speed measurement for pre-conformance test with accurate test results
- **Automatic measurement**
- **Local Delivery and Global Support**

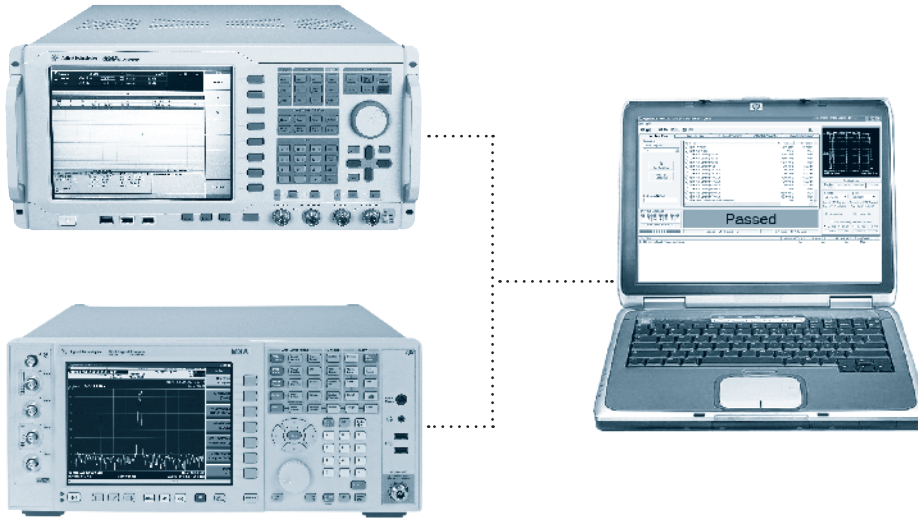

Agilent GS-8800 LTE RF design verification benchtop system is part of the GS-8800 wireless test system family that provides a cost effective entry-level platforms environment for LTE wireless handset RF testing. The benchtop system provide product designers with “just-enough” pre-conformance test coverage that help to ensure better results before a new wireless handset go into full conformance testing. This help to reduce their cost of design validation by increase the passing rate at the first time when undergoing a complete conformance testing.

The benchtop system is design accordance to 3GPP specification TS36.521-1 test cases which covers basic transmitter (Section 6) and receiver (Section 7) test cases.

The benchtop system provides an upgradeable path for customer who which to upgrade to a full blown LTE RF test system and support other technology format by protecting and leverage customers existing investments on benchtop solution.

Quick Reference Table for U1905A Hardware and Software Component

Component	Part number	Description
Hardware	IPC	Industrial PC
	E6621A	PXT wireless communication test set
	N9020A	MXA signal analyzer
	U1905A-LT1	LTE Benchtop accessories
Software	U1908A-1FP	Core test manager fix and perpetual license
	U9511A-1FP	Bench-top LTE FDD Section 6 (Tx) DV test cases license – fixed & perpetual
	U9511A-2FP	Bench-top LTE FDD Section 7 (Rx) DV test cases license – fixed & perpetual
	U1908AS-xxx	Software and technical support contract license
Optional	66319D	Power supply

Specification

Description	Specification	Supported band
LTE	3GPP TS36.521-1	Band 1 to 17

Ordering Information

U1905A GS-8800 Series (PXT) wireless communication design verification (DV) Benchtop system.

Contact Agilent Technologies to configure a customized test system.

Web Link

www.agilent.com/find/gs8800

E9903E

E9902E

E9905E

E9901E



The Agilent *Medalist* i3070 Series 5 in-circuit test system comes with industry-leading limited access test technology, including the multiple-award winning cover-extend technology

The Agilent *Medalist* i3070 Series 5 test system offers a new analog stimulus and response unit (ASRU) card that includes a new digitized measurement circuit (DMC) with additional test features and faster analog test throughput of up to 20% of overall analog test time.

The Series 5 ICT also offers a new infrastructure that allows manufacturers to incorporate external circuits easily for added test coverage while at the same time providing better control of these circuits. Here are the latest features on the Series 5:

New Agilent Utility Card

The new Agilent utility card gives users the flexibility to incorporate external circuits to balance between ICT and functional testers and reduce investment on functional testers. Users can now use their Series 5 ICT for even faster in-system flash programming, boundary scan and LED testing, among other uses.

New Analog Measurement Card

- Two channels of high current capabilities of up to 10 A per channel
- Power monitoring circuit (PMC) safety feature – provides real time monitoring but also helps users to distinguish between a power supply failure or a digital test failure
- Fixture power supply – for fixture electronics and other external powering purposes. The user can enable or disable this with BT-BASIC commands
- 60 V zener testing capabilities – today's boards need higher voltage power supply, with larger zener diodes. With the new ASRU card, a maximum of 60 V zeners can be tested instead of up to 18 V
- Digitized measurement circuit (DMC) with new frequency options – the DMC speeds up analog testing by using multiple ports on a microcontroller to digitize, at one time, the multiple readings taken during a test

Software Enhancement

The Series 5 also includes software and enhancements listed below, and retains all the user-friendly features of the original i3070 system, such as:

- DC test method for large capacitor testing
- Ease of use with point-and-click interfaces
- Board locator – for easy location of components on the board under test as well as probes and testhead resources
- AutoOptimizer – reduces test time by 10 to 50 percent per test
- AutoDebug – with the click of a button, the system can perform a complete analog test debug in a matter of hours. AutoDebug fine-tunes tests so boards pass reliably in production

Web Link

www.agilent.com/find/i3070

www.agilent.com/see/limitedaccess

www.agilent.com/find/utility

U9401B



The *Medalist i1000D* can perform digital PCF/VCL library-based testing, boundary scan and I²C/SPI serial programming on a simple, low-cost long-wired test fixture

The Agilent *Medalist i1000D* is now even better. Improving from its previous state of an analog-only ICT, the new digital release of the system now features per pin programmable digital cards and a whole new set of intuitive software graphical user interfaces (GUIs) that makes programming and development effortless.

With its new digital capabilities, the *Medalist i1000D* now can perform digital PCF/VCL library based testing, Boundary Scan and I²C/SPI serial programming on a simple, low-cost long-wired test fixture. This presents an excellent opportunity for customers who are looking for better test coverage without any increase in cost.

Here's what users can expect:

Digital Coverage

The digital subsystem of the *i1000D* harnesses the simplicity and power from the industry-leading *Medalist i3070* ICT, to bring customers the power to adjust test speeds, drive and receive voltages with just a few clicks of the mouse.

Complete Boundary Scan Capabilities

Putting even more ICT power in the hands of its users, Agilent has equipped the *i1000* with full boundary scan capabilities, from standard boundary scan and connect test to interconnect test.

Powerful Debug Interface

The digital debug GUI leverages the control and flexibility of the legendary *i3070* PushButton debug GUI, allowing engineers and technicians to have full control of the digital test parameters and test source codes.

Low-Cost Fixturing

The *Medalist i1000D* runs digital tests using a traditional MDA-style longwired press down fixture. Boundary scan tests, serial programming, library-based tests all run without a glitch. Users now have a test solution that is simple and effective, and at the same time keep their operational costs down with the MDA-style fixtures.

Web Link

www.agilent.com/find/i1000

- Just enough test capability system based on the industry-leading Agilent 34980A
- Open software and hardware architecture for future enhancements
- WW support and customization team with the expertise to meet specific customer requirements



TS-5020 (E2240A L2000 MAC panel)

Testing of:

- AM/FM/RDS simulation
- In-car GPS
- In-car *Bluetooth* compatible applications
- DAB/DVB broadcasts
- In-vehicle mobile communications
- ISDB-T

TS-5020
TS-5030

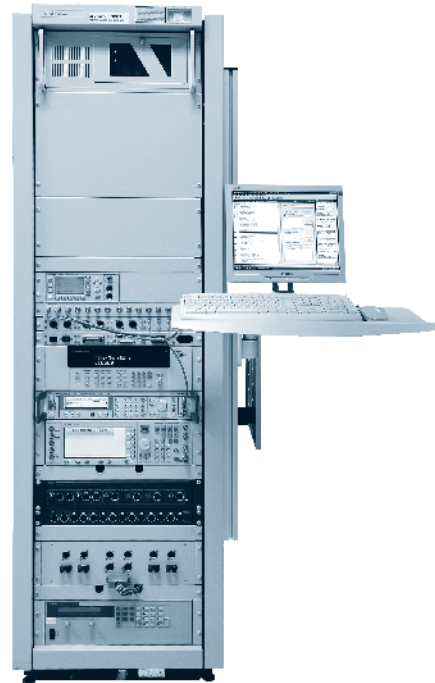

TS-5030

Automotive Functional Test Systems

With the look and feel of the higher-end TS-5400 Series II, the TS-5020 addresses the requirements for a lower cost measurement system catered for medium pin count range with light duty switching. Its diverse ability to test simple ECMs like airbag, ABS/TC and tire pressure monitoring has made it possible for the TS-5020 to meet price for performance value.

Specifications

- Interface: Express Connect and L2000 MAC panel
- Controller: Advantech IPC industrial grade PC
- Test executive: Agilent TestExec SL current release 7.0, preloaded with the TS-5400 Autolibs which provide more than 609 actions
- GPIB instrumentation: variety of GPIB equipments to enhance your measurement capabilities
- Power supply: GPIB power supplies from the Agilent 66xxA family ranging from 200 to 2000 W, including the new modular power supply from the N67xxB family with LXI capability
- Serial communications: Engenius Multicom III – multipurpose communication adapter capable of supporting common automotive communication protocols like ISO 9141, ISO 9141-2, CAN, J1939, J1850, ford SCP, fault tolerant CAN, single or dual wire CAN
- Switching: measurement switching provided by Agilent 34980A, multifunction switch/measurement unit with built-in 6.5 digit DMM which allows for both DC and RF switching
- Mini switch/load unit (SLU): 6-slot mini SLU designed with a flexible load topology capable of meeting any load strategy

Automotive Infotainment and Telematics Functional Test Systems

The new TS-5030 is an infotainment system that allows you to focus on your desired test with upward compatibility as required. It is more than just a system – It's a total solution that can be customized to your needs, including the fixturing and interface.

This infotainment platform is capable of managing a broad range of tests for analog as well as digital broadcasting, mobile communications and telematics information networks.

Specifications

- Audio loadbox that handles up to 6 channels – 4 fixed and 2 customizable
- Audio analysis that provides reliable and accurate test capabilities
- AM/FM/RDS simulation
- GPS simulation of single and multi satellite signals using I/Q files allowing flexibility on data content and length
- Using I/Q files to enable DAB/DVB/ISDB-T
- Customization
- Combination of XLR, SMA, BNC
- Express Connect
- L2000 MAC panel

Web Link

- www.agilent.com/find/ts5020
- www.agilent.com/find/ts5030
- www.agilent.com/find/automotive
- www.agilent.com/find/testexec

E8780B
Express
Connect
E8786B
Series 75
MAC panel
E2230A
low profile
Express
Connect
E2011FA
E2011GA –
TestExec SL

- High test throughput for automotive functional test applications
- Fast test generation process using integrated hardware and software
- Reliable high quality tests for automotive manufacturers
- Flexible architecture allows re-use and investment protection



TS-5400 (E8780B Express Connect)



TS-5400 (E8786B Series 75 MAC panel)

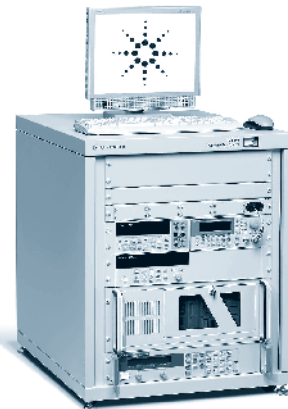

TS-5410 (E2230A low profile Express Connect)

Agilent's automotive test systems provide customers with a scalable family of software compatible testers allowing rapid test development and significantly decreasing cost of test. These systems can be configured to test many different electronic control modules (ECMs) for the customer to buy just enough test capability. The test and measurement capability of these systems ensures high quality tests for these electronics manufacturers. Agilent's global delivery and support provides customers with the ability to easily transport their test systems as manufacturers balance worldwide capacity.

TS-5400

The TS-5400 is available in two configurations. The full size E8780B system with the Express Connect interface can handle 30 to 150 test points. This model is ideal for testing ABS, traction control, airbag, navigation, information, and entertainment modules.

The high-performance E8786B system offers additional measurement horsepower for complex modules such as those used for engine management, power train control and body electronics. A MAC panel test system interface provides maximum flexibility when connecting with devices with 50 to 300 test points.

TS-5410

The TS-5410 automotive functional test system is a fully integrated platform ideal for low pin count applications. This system is capable enough to deliver a complete measurement solution yet small enough to fit beneath standard conveyor lines. The TS-5410 uses the low profile Express Connect interface that provides tremendous flexibility for specific test requirements and is pre-wired and fully documented for easy integration into production lines.

TestExec SL Software

All systems include fully integrated software and documentation. TestExec SL software is a mature test executive that combines with the TS-5400 application software to provide a development environment and a library of over 400 test routines. Its integrated programming language – Microsoft Visual Basic for applications (VBA) – supports rapid system development and debugging.

Accessories

Stand alone accessories, spare parts and upgrades are available for all test system families, and can be ordered using the following reference numbers:

E8781A for the E878XB systems
E2231A for the E2230A systems

Web Link

www.agilent.com/find/ts5400
www.agilent.com/find/ts5410
www.agilent.com/find/automotive
www.agilent.com/find/testexec

8163B
8164B
N7700A

Modular and Multi-Channel Test and Measurement Platform for Optical Components and Optical Networks

Flexible – free combination of Agilent modules for the best fit to each application

Scalable – the right form factor for each setup in R&D and manufacturing for single-port and multi-port applications

Efficient – plug&play drivers and the photonic application suite software from Agilent provide a variety of application functions for increased measurement performance

Fast – modules and controllers optimized for high test speed and data throughput

Ergonomic – comfortable color, high contrast displays for enhanced stand-alone benchtop usability

This family of optical test instruments and modules covers all kinds of fiber-optic test capability from tunable and fixed sources via signal and path control to a broad range of optical power measurement modules and instruments. Different form factors and performance classes allow an easy adaptation to any test need and support both manual use and remote control via LAN and GPIB. A common remote language lets you control all test module categories with the same set of commands.



8163B – Modular Stimulus-Response Solutions with Excellent Performance

The two-slots Agilent 8163B lightwave multimeter is one of the basic measurement tools in the fiber optics industry. Its modularity and compact format makes it flexible enough to meet changing measurement needs, whether measuring optical power and loss with laser and power meter modules or using attenuator and switch for signal conditioning.



8164B – the Platform for Testing Optical Components

The Agilent 8164B lightwave measurement system supports a wide range of tunable laser modules together with capacity for up to 8 power meters in one box, for high resolution spectral testing of passive components. Its LAN and GPIB ports provide connectivity for remote control that can be utilized for system automation, supported by Agilent's software suite. For easy standalone operation of the 8164B, the large display and comfortable controls make this a great benchtop tool.

The Agilent 8163B and 8164B Mainframes and Optical Modules have Commonly Used Built-in Applications for Quick Manual Testing Without Programming:

- **Passive component test (PACT)** – measure spectral insertion loss with a tunable laser module and one or more power meter modules
- **Return loss/loss** – measure the return loss and insertion loss of your devices with one of the 8161xA return loss modules and a power meter module (8163B only)
- **Stability** – check the long term power stability of the device under test with a source module and a power meter module or power head
- **Logging** – perform statistical analysis on the power readings of your device



77-Series of Multi-Channel Power Meters, Attenuators and Tunable Laser Sources

The characterization of parallel optical devices or parallel testing of optical devices demands a new set of optical test equipment, which provides cost-effectiveness, high measurement throughput and parallel data acquisition and data aggregation. Agilent's 77-Series expands the optical test and measurement family to address this kind of test demand.

The instruments are controlled via a Graphical User Interface (GUI) on your PC or laptop computer, which reduces the eliminates the additional cost of an instrument display, controls and the related electronics. The GUI let us you monitor and control the multiple channels at a glance and gives a quick status information.

Powerful full functionality is available by remote control via USB, LAN or GPIB.

8163B
8164B
N7700A

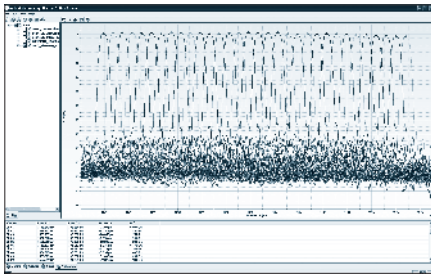
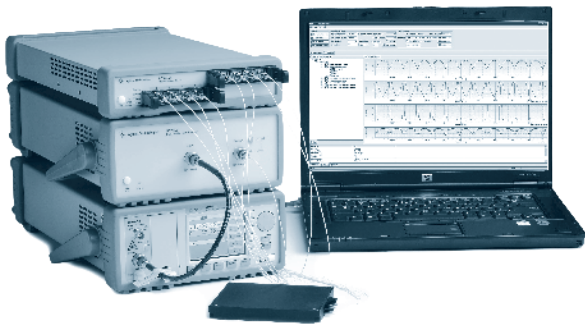

N7700A Photonic Application Suite

The N7700A photonic application suite is a modular software platform for fast, easy and advanced characterization and analysis of optical components and signals. This suite is widely distributed with instruments and available from the Agilent website and can be installed on PCs to control instruments and to process and analyze measurement data.

The freely-distributed main package of the N7700A photonic application suite provides a powerful file viewer program that allows viewing and analyzing measurement data. It has been designed for sharing measurement results throughout entire development teams or manufacturing groups.

The file viewer uses the same N77xx Windows-based graphical user interface that is used in the measurement engine packages. The controls for this interface can also be built into customized programs for automated data display.

Features include:

- Display and overlay of traces from multiple channels and multiple measurement files
- Scale switching between wavelength and frequency
- Display of tabular analysis
- Smoothing, markers and zooming
- File loading, saving and data export
- Direct launching of Excel and Matlab with data

For performing measurement tasks, an increasing range of *application packages* are available. Some basic ones are available free for use with the instruments. Licenses can be purchased for more advanced packages. All packages can be downloaded and used immediately for a 14 day trial period and 60-day evaluation licenses can also be generated automatically from the Agilent web site for extended consideration.

- The *insertion loss measurement package* performs very accurate swept-wavelength insertion loss measurements using one of Agilent's tunable laser sources along with optical power meters. No license required.

The *fast IL/PDL measurement package* makes rapid and very accurate measurements of spectral insertion loss and polarization dependent loss (PDL) characteristics of multiport optical components. The new single sweep Mueller Matrix method provides speed and immunity from vibrations and noise.

In addition to the measured IL and PDL traces, the Mueller Matrix data can be exported and analyzed to provide the polarization resolved IL traces for the device axes (TE/TM) and pass-bands can be analyzed for PDL and PDA.

License available for purchase as N7700A Option 100.

The *filter analysis package* provides extended post-processing of measurements from the IL/PDL and IL measurement packages for analysis of narrow-band components like filters and multiplexers. Analysis parameters include peak and center wavelength, wavelength offset from ITU grid, IL at ITU wavelength and center wavelength, bandwidth and channel isolation from adjacent and non-adjacent channels.

License available for purchase as N7700A Option 101.

The *polarization navigator package* provides all the tools needed for your work with N778x polarization analysis and control instruments: measurement of Stokes parameters and degree of polarization (DOP); representation on the Poincaré sphere or time dependent long term monitoring, spike analysis, etc. Various functions for control, switching and scrambling the polarization of optical signals are also provided. No license required for use with N778x instruments.

The *N4150A Agilent photonic foundation library* is well known as the established software for photonic engineers. This library is also integrated with the N7700A photonic application suite and programs using this library can also use the new automation controls for display.

License available for purchase as N7700A Option 200.

	Engines										
	Insertion loss	Polarization dependent loss	TE/TM, PDL/PDA	Peak search, channel isolation	Polarization analysis	Polarization control	PER analysis	Report generator	Data export to Microsoft Excel, Matlab...	Automation interfaces	Photonic foundation library channel analysis functions

Application packages

Insertion loss measurement	•									
IL/PDL component measurement	•	•						•	•	•
Filter/multiplexer analysis			•	•				•	•	•
Polarization analysis and control					•	•	•	•	•	•
Photonic foundation library	•	•	•							•

Web Link

www.agilent.com/find/N7700

- Complete wavelength coverage from 1260 to 1640 nm
- Low SSE output for high dynamic range
- Built-in wavelength meter for high wavelength accuracy
- Sweep speeds up to 80 nm/s to reduce test times
- No compromise of measurement accuracy for sweep speed
- High optical output power up to +9 dB enables splitting the signal among different components and test stations
- Built-in Coherence Control reduces interference effects
- Built-in wavelength meter and variable attenuator for reduced measurement uncertainty and accurate power control

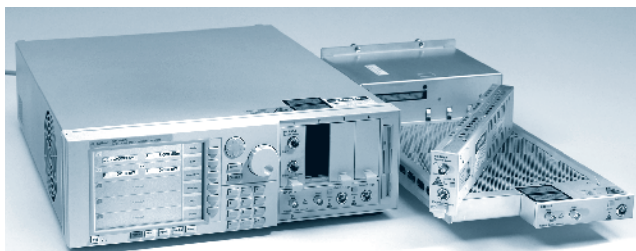

Tuning Range from 1260 to 1640 nm

Agilent offers a family of tunable laser sources to cover the wavelength range of 1260 to 1640 nm. Whether you are measuring dense wavelength division multiplexing (DWDM) devices or a WDM device, such as, an LX4 component for 10 Gigabit Ethernet, Agilent has a laser to fit your testing needs.

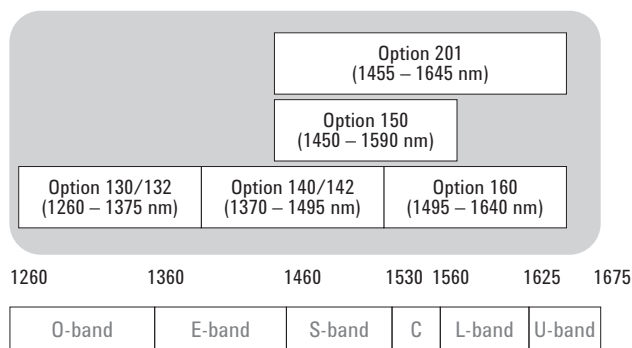

Agilent TLS-portfolio

It Sweeps as Precisely as It Steps

The 81600B offers several sweep speeds up to 80 nm/s without compromising measurement accuracy. In contrast to other lasers, the 81600B sweeps with the same precision as it steps; without the use of an external wavelength-tracking filter. No compromise on sweep speed.

Advantage of Using Suppressed Laser Noise (SSE)

Source spontaneous emission (SSE), the sum of all spontaneous emissions inside the laser diode of the tunable laser, is broadband light output in addition to the monochromatic laser line. This emission limits the noise floor of the tunable laser, which, in turn, limits the dynamic range of your measurements. The Agilent tunable laser source offers a low signal to source spontaneous emission ratio. For you, this means more dynamic range to enable your measurements to completely characterize DWDM devices with high channel isolation.

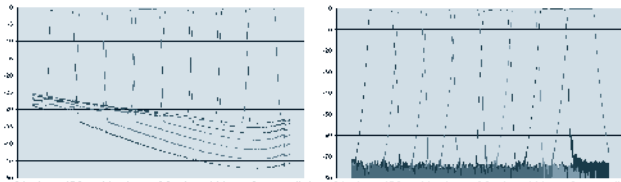

Measurement of DWDM filters with low SSE and high power output

Reduce Cost of Test

For DWDM components, high wavelength accuracy and dynamic range are most important. For CWDM components, a wide wavelength range, high power stability, dynamic range and low cost targets are key. Agilent's state-of-the-art tunable lasers meet the demanding requirements of high tech optical manufacturing facilities with fast sweep speed, high wavelength accuracy and power stability. This will reduce your test time while increasing your throughput, hence, reducing the cost of test in manufacturing to give you the competitive advantage.

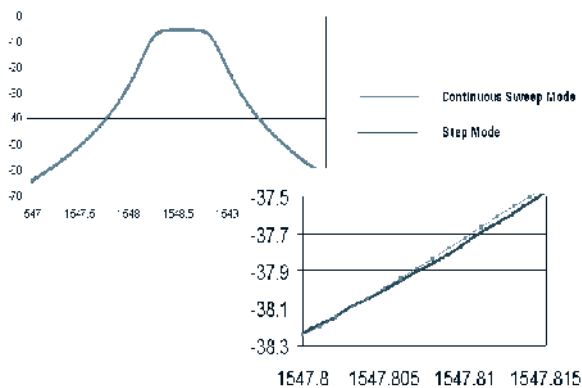

No compromise on sweep speed

Web Link

www.agilent.com/find/tls

81940A
81950A
81980A
N7711A
N7714A

- Compact form factor of tunable laser source
- Up to 110 nm coverage in one module (81940A, 81980A)
- High power output up to +15 dBm (81950A)
- SBS suppression feature enables high launch power
- Built-in wavelength meter for active wavelength control (81940A, 81980A)
- Dynamic power control for excellent repeatability
- Built-in coherence control avoids problems with interference effects



819xx Family of High-power Compact Tunable Laser Modules

81940A, 81980A: Cost Effective Passive Component Test

Agilent's 81940A and 81980A compact tunable laser sources provide excellent wavelength and power accuracies to enable reliable swept wavelength measurement for passive component test in a cost effective way. The built-in wavelength meter with a closed feedback loop for enhanced wavelength accuracy allows dynamic wavelength logging in continuous sweep mode. The integrated dynamic power control loop guarantees highly repeatable measurements. The Agilent 81940A and 81980A cover a total wavelength range of 110 nm, either in the S+C-band with the high power in C (81980A), or in the C+L-band with the high power in the L-band (81940A).

81950A: Ideal for Transmission System Loading

The Agilent new 81950A compact tunable laser source is step-tunable for setting channel frequencies within any grid in the C- or L-band. With high output power up to +15 dBm, narrow linewidth of 100 kHz, and offset grid fine-tuning capability, the 81950A is a universal source for realistic loading of the latest transmission systems. It is available with C-band or L-band wavelength coverage. In wavelength setting mode it can reach any wavelength point within its specified range. In channel setting mode, the grid spacing is adjustable to standard ITU-T spacing like 50 GHz, and to arbitrary grids. Likewise, the zero frequency (base channel) of the chosen grid is adjustable. A 12 GHz fine-tuning range allows de-tuning the frequency with output power on.

Optical Amplifier Characterization at High Power Levels

The high output power enhances test stations for active and passive optical components, and enables the evaluation of nonlinear effects. Engineers can even test optical amplifiers such as EDFAs, Raman amplifiers, SOAs and EDWAs to their limits.

The internal modulation feature enables an efficient and simple time-domain extinction (TDE) method for Erbium-based optical amplifier test when used together with the external gating feature of the Agilent OSA. It also supports the transient testing of optical amplifiers by simulating channel add/drop events.

- Compact instrument format with one or four ports per unit on one-half 19-inch width and one-unit height
- Flexible configuration of four-port model between C- and L-band channels (N7714A)
- Adjustable to any wavelength grid (ITU-T 100 GHz, 50 GHz, 25 GHz, and arbitrary grids)
- Narrow linewidth less than 100 kHz and offset-grid tuning greater than ± 6 GHz ideally suited for coherent mixing applications and new complex modulation formats
- Up to +15 dBm output power, with 8 dB power adjustment range
- Equipped with Panda polarization maintaining fiber



N7711A one-port and N7714A four-port tunable laser source

N771xA Series Tunable Laser Sources

The new Agilent N7711A and N7714A tunable lasers are single-port and four-port sources, available with C-band or L-band wavelength coverage. The narrow linewidth and offset grid fine-tuning capability of the N7711A and N7714A make them ideal sources for realistic loading of the latest transmission systems.

The N7711A and N7714A tunable laser sources are step-tunable within any frequency grid in the C-band (1527.60 to 1565.50 nm; 196.25 to 191.50 THz) or L-band (1570.01 to 1608.76 nm; 190.95 to 186.35 THz). Their output power of up to +15 dBm and a linewidth as narrow as 100 kHz are ideal to emulate state-of-the-art DWDM transmitters. SBS suppression can be activated on demand to avoid stimulated brillouin scattering.

Tuning Modes that Fit Every Application

Each individual laser in the N7711A and N7714A features the same tuning modes as the 81950A: in channel setting mode, the source wavelength (or frequency, respectively) is determined by the chosen channel index, zero frequency and grid spacing; ITU-T standard grids are possible as well as custom grids.

In wavelength setting mode the laser is tunable to any wavelength point within its range, just like any other Agilent tunable laser.

In both modes, each laser channel operates independently and can be detuned by ± 6 GHz with output power on.

Ordering Information

- N7711A tunable laser source 1 port
 - N7711A-210 C-band laser
 - N7711A-201 L-band laser
- N7714A tunable laser source, 4 ports
 - N7714A-240 4 C-band lasers
 - N7714A-204 4 L-band lasers
 - N7714A-222 2 C-band lasers and 2 L-band lasers

Connector Interface Options:

- N771xA-071 straight connector interface, PMF
- N771xA-072 angled connector interface, PMF

Web Link

www.agilent.com/find/tls

- Narrow-band DFB and broad-band Fabry-Pérot lasers
- Excellent CW power stability
- Coherence control modulation for stable readings
- Up to 20 mW output power
- F-P with 1310, 1550 or 1310 & 1550 nm wavelength
- DFB with 1310, 1490, 1550 and 1625 nm wavelength
- F-P with 850 nm and multimode fiber



Fixed-Wavelength Lasers

Flexible Application Fit

Agilent laser sources are valued for their high output stability and simple operation. Typical applications are testing connectors, fibers and components, often together with one or more power meters that fit in the same mainframe. Return loss measurements can also use these sources and benefit from the powerful coherence control to avoid interference instabilities.

Ideal Sources for IL, RL, and PDL Tests

Fabry-Pérot lasers emit at several closely spaced wavelengths within a width of a few nanometers. They are commonly used for testing components without strong wavelength dependence, like fiber connectors. Agilent's 8165xA models have 0 or +13 dBm output power at the common wavelengths of 1310 and 1550 nm and can also be provided for multimode fiber testing at 850 nm.

DFB (distributed feedback) lasers emit at a single narrow linewidth wavelength and have been the backbone of the wavelength domain multiplexed networks. Agilent's 81663A sources are available at the commonly needed wavelengths for FTTH and other single-mode fiber systems: 1310, 1490, 1550 and 1625 nm. The high +13 dBm output power is sufficient for simulating signal loading or splitting power to multiple paths. The effective coherence control modulation allows stable power measurements otherwise only available with F-P or LED sources, while providing accurate and selected wavelength control. These lasers can also be fine-tuned over a range of 1 nm.

- Wide wavelength range
- Excellent repeatability over 10,000 cycles
- Low insertion loss of < 1.0 dB
- Single-mode and multimode fiber models
- Preservation of multimode fiber modal distribution

81663A
81595B



Compact Modular Switches

Automation of test setups and repeatable results are facilitated by including high-quality optical switches. They allow the signal to be applied to multiple instruments and make it easy to quickly make reference measurements, which is important when multiple tests at different conditions or power levels are needed.

Modular Design for Solution Platform

The Agilent modular optical switches are a family of plug-in modules to be used with the 816x Lightwave mainframes. The switches enable manufacturers of optical networks and components to automate their processes by routing optical signals to various test instrumentation. Adding modular optical switches to this instrument platform allows for a flexible and cost effective all-in-one solution to be developed for optical component tests in automated test environments.

The 81595B Option 009 is a 1x4 switch for single-mode fiber and has FC/APC connectors to minimize any impact from inserted return loss. The 81595B Option 062 is a 1x4 switch for multimode fiber and has FC/PC connectors.

Integrating Switches Without Increasing System Uncertainty

High switching repeatability is vital for accurate testing in switched setups. This and low polarization dependence are key characteristics of the 81595B. In addition, the switching technology for the multimode switch has been specially chosen to preserve modal fidelity so that the input modal distribution is also present at the output.

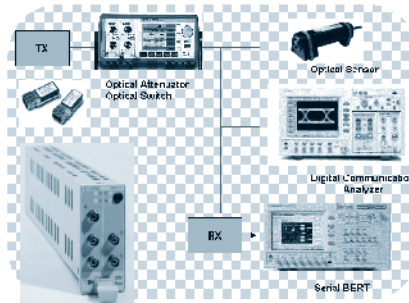

Solution for system integration using optical switch

Web Link

www.agilent.com/find/tls
www.agilent.com/find/voa

81635A
81634B
81636B
81630B
N7744A
81623B
81624B
81626B
81628B
81610A
81613A

- High absolute and relative accuracy
- Low polarization dependence
- Low spectral ripple and high return loss
- Wide wavelength and power ranges
- Flexible and repeatable fiber connectivity
- Data logging for 20 or 100 k points
- Easy integration for multichannel testing
- Easy synchronization with tunable laser

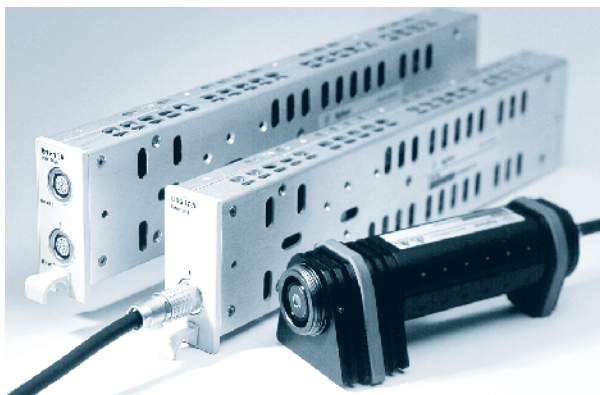

81628B high power head with integrating sphere and with removable heat sink



Return loss modules

The Agilent optical power measurement modules provide high performance and add functionality to the Agilent lightwave measurement platform for fiberoptic applications. These modules can be used with the mainframes 8163B, 8164B or 8166B as well as the earlier 816xA models.

Power sensor modules provide a front panel optical input that accepts various 81000xl connector interfaces for popular fiber connector types or bare fibers. Besides giving optical power in units of W or dBm or dB referred to a reference, calibrated for any wavelength in the available range, these advanced instruments provide high speed data logging of up to 20 k (100 k for the 81636B) values, triggered internally or externally. The min-max function keeps the maximum and minimum values continuously or over a chosen number of samples for simple determination of power variations. Averaging times can be set from 10 s down to 100 μ s (25 μ s for the 81636B).

Optical heads provide a 5 mm diameter detector area and allow flexible placement of the power meter which is then connected to the 81618A or 81619A interface module in the mainframe. The 81628B has a built-in integrating sphere input for measuring high power levels. The functionality is the same as for the sensor modules and a choice of adapters allows input from popular connector types, bare fibers or open beams. The simple geometry and high quality detectors allows the heads to offer the highest accuracy measurements. Special calibrations, especially to the 81624B, provide metrology lab reference quality. The magnetic D-shaped adapters allow rapid removal and replacement on the head without twisting attached fibers.

Return loss modules use two power sensors and fiber couplers to provide a direct measurement of the optical return loss. One sensor measures the optical power reflected back to the instrument while the other monitors the optical power output from the instrument. The ratio provides the return loss. These modules can use an external light source and can also be provided with internal Fabry-Perot lasers for very stable measurements. Full calibration functions are available and especially supported by a built-in application of the 8163B. Using remote programming, these can also be configured to log up to 20 k values from each sensor, synchronized with a tunable laser attached to the external input for making wavelength-dependent RL measurements.

As with the complete lightwave measurement platform, remote programming is available with SCPI commands and especially convenient using the 816x VXI *Plug&Play* driver. This driver simplifies power logging and coordinated measurements with tunable lasers, especially with multiple power meters.

Selection Guidance

Sensors

- 81635A** dual-channel sensor, lowest price
- 81634B** most accurate sensor, highest sensitivity
- 81636B** fast power sensor, 100 k points, 25 μ s averaging, higher dynamic range during logging
- 81630B** highest power sensor
- N7744A** see also next page for multiport sensors with averaging time down to 1 μ s, and 1000 k points logging

Heads

- 81623B** Ge head, general purpose, also specified for 850 nm
- 81624B** InGaAs head, highest accuracy
- 81626B** InGaAs head, high power with high relative accuracy
- 81628B** InGaAs head with integrating sphere, highest power and accuracy at high power

Return loss modules

- 81610A** for use with external source only
- 81613A** built-in 1310 & 1550 nm FP sources & external input

Web Link

www.agilent.com/find/mppm

Multiport Optical Power Meter and Optical Attenuators

N7744A, N7745A Multiport Power Meters and 8157xA High Performance Modular Attenuators

301

- 1 μ s minimum averaging time
- Dynamic range during logging up to 65 dB
- 1 M points logging +1 M points buffer, per port
- Data streaming: parallel measurement and transfer
- High bandwidth, up to 240 kHz at 3 dB-cutoff
- Low polarization dependence of $< \pm 0.01$ dB typ.
- 1250 to 1650 nm wavelength range
- Fully compliant to LXI Class C



N7744A, N7745A Multiport Power Meters

Agilent's N7744A and N7745A optical power meters with four or eight power-sensor channels enable increased throughput and operational efficiency to meet today's challenges in manufacturing. Designed for characterizing optical multiport components, these optical power meters offer industry-leading solutions for device connectivity, high-speed measurement data acquisition and fast data transfer for post-processing.

Transient power measurements benefit from the data acquisition up to 1 M samples/s, so oscilloscope-like measurements can be made directly. Each port can log up to 1 million points and a full 1 M point buffer supports continuous measurements while data is uploaded to the controller PC for time-dependent and transient power measurements. The sample averaging time can be set from 1 μ s to 10 s and the bandwidth is adjusted to correspond, up to 240 kHz.

For spectral insertion loss and PDL measurements together with a tunable laser, this instrument is a key part of systems using the N7700A software, helping to realize testing that is 10x faster than previous measurement solutions. The high dynamic range during logging speeds measurements of filters with high wavelength isolation by eliminating the need for multiple wavelength sweeps with different power ranges. The high data throughput via USB or LAN is especially important for fast testing of devices with many ports, like multiplexers and wavelength selective switches.

The instrument realizes an unprecedented, patented solution to separate the task of connecting fibers from the measurement task and location, allowing operators to comfortably attach fibers or connectors to the quad-adaptor while the power meter is measuring other devices.

Available quad adapters include:

- N7740FI for PC connectors
- N7740SI for SC connectors
- N7740LI for LC connectors
- N7740MI for MU connectors
- N7740BI for bare fiber connections

Web Link

www.agilent.com/find/mppm

- Low insertion loss of 0.7 dB
- Constant attenuation versus wavelength
- Single-mode and multimode fiber models
- High attenuation resolution of 0.001 dB
- Active power monitor and control
- Exchangeable Agilent 81000xl connector interfaces



N7744A
N7745A
8157xA

8157xA High Performance Modular Attenuators

Agilent's 8157xA variable optical attenuators are ideal for controlling the power and preserving the quality of optical signals. Reflective bulk-optic filtering controls input power up to 2 W with high resolution, repeatability and accuracy. The attenuator modules 81570A, 81571A and 81578A occupy one slot, while modules 81576A and 81577A with power monitoring occupy two slots of any of the 816x lightwave mainframes.

Wavelength-Flat Attenuation and High Power

The specially designed reflective filters give excellent wavelength flatness and can handle input power levels of 2 mW. This attribute combined with the low insertion loss make them ideal for optical amplifier tests, and other multi-wavelength applications, like DWDM transmission system simulations.

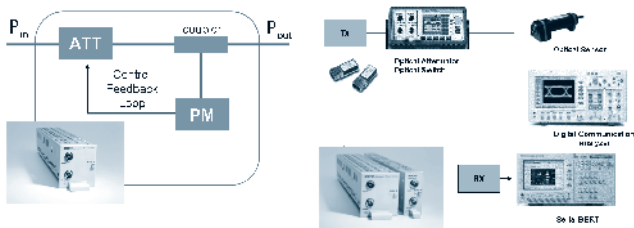

Modal Fidelity for Multimode Fiber Systems

Signals in multimode fibers are distributed over a range of mode groups that can have different loss and delay in a link. For dependable multimode transceiver testing, the instrument used to set the power level should not change this modal distribution. The bulk-optic filter and collimated beam path of Agilent multimode attenuators are the best way to assure homogeneous attenuation of all input modes.

Variable Optical Attenuators

The Agilent 81570A, 81571A single-mode and 81578A multimode attenuators provide flexible attenuation in a single-slot module. Flexible calibration features allow offsetting the displayed attenuation for other insertion loss in the setup. The mechanical shutter can be used for protection from high power signals or to simulate channel drops.

Attenuators with Power Control

Agilent's 81576A and 81577A attenuators have an added feature of power monitoring and dynamic control. This is especially useful for setting desired power levels directly. When the power control mode is also enabled, the module automatically corrects for power changes in the input signal to maintain the chosen output level. The displayed power can also be offset for other insertion loss in the system with an easy calibration process. This offset can also include wavelength dependence.

Web Link

www.agilent.com/find/voa

N7751A
N7752A
N7761A
N7762A
N7764A
N7768A

- 0.05 dB relative power setting accuracy
- Settling time: 20 ms attenuation, 100 ms power, 200 ms multimode
- Miniature bulk optics for best multimode transfer distribution
- 0.1 to 1000 dB/s or for multimode to 100 dB/s attenuation transition speed (selectable)
- +23 dBm max. input power
- ≤ 1.2 dB insertion loss
- 45 dB single-mode attenuation range (typ.)
- 35 dB multimode attenuation range
- -50 to +20 dBm power setting range
- Fully compatible with setups and programs developed using the Agilent 8157x modular attenuators
- Two instrument configurations can be stored and recalled

The Agilent N775xA and N776xA series compact multi-channel attenuators and power meters are a new class of remote controlled fiber optic instruments for optical transceiver and network integration test. All attenuators include an internal power monitor for each channel to reduce the complexity of closed-loop setups like those needed for very accurate BER testing or eye mask analysis by allowing power to be set directly rather than needing to set an attenuation value. All attenuators feature both attenuation mode and power control mode: In attenuation mode, the calibrated value of attenuation in dB can be set. The rate of attenuation change during setting can be adjusted between 0.1 and 100 dB/s for multimode or up to a very fast 1000 dB/s for single mode.

In power control mode, the instrument uses its integrated power monitor to set the desired power level at the output of the module. It automatically corrects for input power changes so that the output power level is maintained. Absolute power levels can be set with high accuracy after an initial offset calibration.

Modal Fidelity for Multimode Fiber Systems

Signals in multimode fibers are distributed over a range of mode groups that can have different loss and delay in a link. For dependable multimode transceiver testing, the instrument used to set the power level should not change this modal distribution. The bulk-optic filter and collimated beam path of Agilent multimode attenuators are the best way to assure homogeneous attenuation of all input modes.

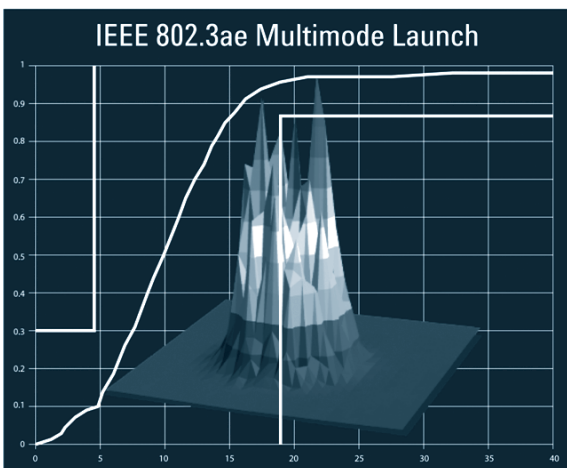

N776xA Multi-channel Optical Attenuators with Internal Power Control



1-channel variable attenuator N7761A



2-channel N7762A SMF attenuator or N7766A MMF attenuator



4-channel N7764A SMF attenuator or N7768A MMF attenuator

N775xA Multi-channel Optical Attenuators with Internal Power Control and External Power Meter Channels

The 2 integrated power meters in the N7751A and N7752A allow convenient measurement of optical power from different stages of the test setup and provide a very convenient and automatic way to calibrate the attenuator power reading to the power actually present at another point, such as the input to the receiver under sensitivity test. This calibration can thus correct for insertion loss due to switches and other components between the attenuator and the point of interest.

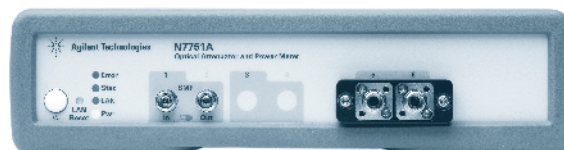

1-channel attenuator with two power meter channels N7751A

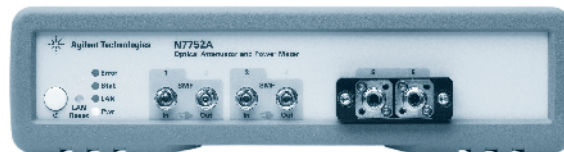

2-channel attenuator with two power meter channels N7752A

Web Link

www.agilent.com/find/voa

N7781B Polarization Analyzer

- Measurement of Stokes parameter (SOP)
- Measurement of degree of polarization (DOP)
- High-speed operation (> 1 MSamples/s)
- Analog output port for DOP/SOP data
- Robust, no moving parts

N7782B PER Analyzer and N7783B Thermal Cycling Unit

- Accurate PER-measurement up to 40 dB
- Real-time display of PER
- Easy-to-use: reliable results independent of operator skill set
- Swept-wavelength and heating/stretching method available
- Measurement of the PER versus wavelength
- Fast/slow axis detection and angular offset determination
- Full single-mode fiber range: 1260 to 1640 nm
- Internal fixed wavelength sources at 1310 and/or 1550 nm available

N7788B Optical Component Analyzer

Advanced analysis in the polarization navigator software provides:

- DGD, PMD, PDL, and 2nd-order PMD versus wavelength
- Power and insertion loss (IL)
- Polarization resolution of IL to TE and TM traces
- Polarization dependent frequency/lambda analysis of channels
- Principal states of polarization (PSPs)
- Jones and Mueller matrix export

N7781B Polarization Analyzer

The Agilent N7781B is a compact high-speed polarimeter for comprehensive analysis of optical signal polarization. This includes representation of the state of polarization (SOP) on the Poincaré sphere and logging of the Stokes parameters. The calibration and algorithms data ensure high accuracy across a broad wavelength range. High speed sampling up to 1 MSamples/s support real-time monitoring and logging for analyzing disturbed and fluctuating signals as well as for control of applications requiring real time feedback of polarization information. Analogue data output ports are provided, for example for support of control loops in automated manufacturing test systems. The instrument is controlled from an external PC with powerful Polarization Navigator software or automated programs via USB or GPIB.

N7782B PER Analyzer and N7783B Thermal Cycling Unit

Agilent's N7782B PER analyzers is a specialized instrument for fast and accurate testing of the polarization extinction ratio (PER) in PM fibers. The full polarimetric method based on repeatable heating or stretching of the fiber determines the true PER versus only the degree of linear polarization. The real time measurement capability in combination with automation interfaces makes this unit ideally suited for integration in manufacturing systems, for example pig-tailing stations for laser diodes and planar waveguide components. Analog interfaces are provided for integration of the system in control loop applications. The N7783B thermal cycling unit is fully controlled by the Agilent N7782B PER-Analyzer and allows accurate and repeatable temperature cycling of the PM fiber under test. This cycling causes the output SOP to trace a circle on the Poincaré sphere. The radius of this circle is analyzed to give the PER. This is used for example to measure the PER of the signal output from a laser fiber. A similar procedure using two heaters, one before and one after the test point, can be used to find the alignment of PER connections or splices. The N7783B can also be used with the N7781B and N7788B.

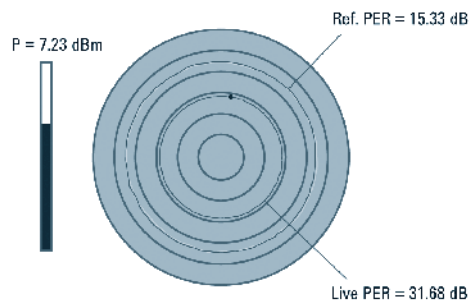

N7781B polarization analyzer



N7782B PER analyzer

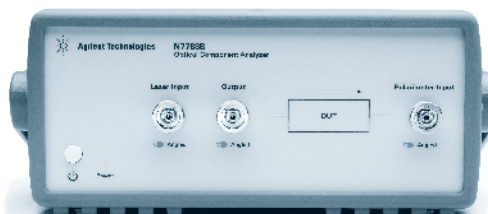

N7788B optical component analyzer

N7788B Optical Component Analyzer

Agilent Technologies pushes the limits of component measurements with the N7788B optical component analyzer, which combines a fast-switch polarization controller with a high-speed polarimeter to make polarization resolved stimulus-response measurement of passive devices and fibers. Its proprietary technology is an optimized implementation of the industry-standard Jones-Matrix-Eigenanalysis method (JME) for measuring polarization mode dispersion (PMD) or differential group delay (DGD) of optical devices. The instrument is synchronized with an Agilent tunable laser source to provide a complete measurement with one continuous wavelength sweep, providing fast and accurate results that are robust against environmental instability like vibrations and temperature changes.

The N7788B is usually combined with a continuous-sweep Agilent tunable laser like the 81600B or 81940B for these single-sweep DGD and PDL measurements.

The N7788BD integrates a PC controller and touch screen with the N7788B instrumentation.

N7781B
N7782B
N7783B
N7788B
86038B

N7781B
N7782B
N7783B
N7788B
86038B

- **Fastest measurement speed for manufacturing test**
- **Highest CD and PMD accuracy and resolution for manufacturing and R&D**
- **Specified operation over 1260 to 1640 nm (O-L band)**
- **2nd-order PMD, GD-ripple and other analysis functions**
- **Expandable for enhanced PDL accuracy and multiport use**
- **Industry-standard measurements with the modulation phase shift method for measurements to any length**



86038B Photonic Dispersion and Loss Analyzer

The Agilent 86038B continues Agilent's long tradition in measuring chromatic dispersion. The instrument provides fast, swept-wavelength, polarization-resolved dispersion and loss measurements. It simultaneously measures chromatic dispersion (CD) and group delay, polarization mode dispersion (PMD) and DGD, insertion loss (IL), and polarization dependent loss (PDL) and optical length and phase. An advanced implementation of the industry standard modulation phase shift method (MPS) provides fast CD and GD traces with selectable wavelength resolution and low noise without repeated averaging. Use of the polarization resolved MPS method with a wide range of modulation frequency allows measurements to any device length and to highest resolution.

The 86038B uses the industry standard modulation phase shift (MPS) method for both GD/CD and DGD measurements. The advanced implementation of the MPS method delivers both high GD and wavelength resolution. The basic method is standardized in IEC 60793-1-42. The method is documented for DGD and PMD in other standards such as IEC 61280-4-4. This is the one method that can determine a DGD value from measurements only at that wavelength, allowing high resolution with low noise.

The 86038B uses fast swept measurements that are ideal for manufacturing. On the manufacturing floor, success depends on high volume throughput, fast ramp-up and reduced cost of test. Trust in your results is vital. The MPS method used on the 86038B avoids sensitivity to thermal drifts and mechanical vibrations. And the drift correction feature assists in obtaining repeatable and stable measurements even in an unstable environment.

Key Capabilities

Simultaneous GD, CD, DGD, PMD, IL, and PDL spectra with a single connection and a single setup reduce test time, instrument footprint and measurement uncertainty.

- CD uncertainty: ± 0.07 ps/nm; ± 0.3 % CD
- Zero dispersion wavelength uncertainty: ± 0.015 nm
- Group delay repeatability: $< \pm 0.03$ ps ($< \pm 30$ fs)
- PMD uncertainty: ± 0.07 ps
- Differential group delay uncertainty: ± 100 fs
- Enhanced PDL and insertion loss accuracy: PDL < 0.05 dB, Loss < 0.02 dB
- High speed swept measurements: DGD measurements over 100 nm can be obtained in less than 30 seconds
- GD/CD measurements automatically corrected for PMD
- Allows very accurate CD measurements
- 6 polarization-state measurements: this selectable method adds additional accuracy to polarization measurements, especially over wide wavelength ranges
- Up to 4-port component testing: Agilent's 81595B modular optical switch allows testing of up to 4 ports of a multichannel DUT
- Wide dynamic range: > 40 dB
- Flexible choice of wavelength range: from 1260 to 1640 nm
- Supports multiple wavelength band operation: by controlling up to 4 tunable lasers. Automatic laser switching is available on request
- Drift correction: provides excellent stability and accuracy when the environmental conditions of the room or the test device are gradually changing
- Selectable and high wavelength resolution: resolution to < 0.2 pm for challenges like GD ripple characterization and up to 2.5 GHz MPS modulation frequency for lowest noise fiber characterization
- Powerful remote control: write your own applications for enhanced measurement control and analysis

Fast and Accurate Length Measurement

In a few seconds, the fiber or device length can be determined, short or long. The measurement, according to the standard IEC 60793-1-22 and using the modulation frequency range of the 86038B supports determination of CD and PMD coefficients of fiber, the dependence of dispersion on length. The short length accuracy of 0.02 mm corresponds to absolute delay measurements with 100 fs accuracy.

Web Link

www.agilent.com/find/pol



N7784B



N7786B



N7785B



8169A

N7784B
N7785B
N7786B
8169A

Agilent offers a wide range of instruments that control the state of polarization (SOP) of an optical signal for various applications. Some measurements should confirm that the performance of an optical component does not exceed acceptable dependence on polarization, such as tests for polarization dependent loss (PDL) and polarization mode dispersion (PMD). In other cases, a signal with specific polarization should be tested.

N7784B, N7785B, and N7786B

These 3 instruments are all based on high-speed solid state optics to rapidly switch the polarization of an incoming signal. They are used with polarized input signals from lasers and can adjust, scan or align the output state of polarization. The instruments are controlled from an external PC and convenient graphical user interface control is provided with the included polarization navigator software, distributed with the N7700A photonic application suite. Automated control is provided by the GPIB and USB interfaces.

The *N7785B synchronous scrambler* provides fast SOP switching in response to internal or external triggering. This supports optical network simulations that often require switching of the signal SOP in a random way within a few microseconds, such as in recirculating loop tests. The SOP is switched rapidly, and then held for a predefined time until it again switches to a new SOP. The output SOP is controlled but not determined by the N7785B and will be changed if the input SOP changes. The output SOP can be adjusted to a desired external condition, such as maximizing the signal through a polarizer.

Application routines in the polarization navigator software can be used for random scrambling and continuous scrambling (where the state of polarization moves smoothly over the Poincaré sphere, similar to a flipper-style scrambler) over a wide range of speeds.

The *N7784B polarization controller* provides alignment and fast stabilization of SOP into polarization maintaining fiber (PMF) or with respect to an external condition by adding an analog feedback and polarizer path to the basic N7785B configuration.

For alignment into PMF, the input signal is first routed through the fast switching controller with single-mode fiber (SMF) and is available at an intermediate front panel output. An external jumper fiber is used to route the signal into the polarizer path consisting of a polarizing beam splitter with one output monitored by a photodetector. The other output is coupled to the front panel output with PMF. The signal from the photodetector is used to actively align and stabilize the input signal into the PMF output that could then be connected to a modulator or other polarization dependent device.

Similarly, the signal can be used directly from the intermediate output and a user-configured setup can provide the feedback for optimizing the desired SOP from the instrument.

The *N7786B polarization synthesizer* includes internal SOP monitoring and feedback via a tap coupler to determinately set and hold any chosen states or sequences of polarization. This allows generation of sequences with chosen relative SOP orientation. This is often used for component

analysis based on Mueller matrix or Jones matrix analysis. The uniquely fast switching supports the new single-sweep spectral PDL measurements with the N7700A software, which eliminates sensitivity to environmental stability and minimizes measurement time. Analysis of these results into transmission spectra of the primary device axes (like TE and TM) is also achieved in this way. The real-time monitoring and logging of output SOP permits accurate calculation including the wavelength dependence of the SOP.

The real-time monitoring and feedback also are used in this instrument to provide stabilized SOP, even with fluctuation and drift of the input SOP. The output SOP can be defined in following ways:

- **Set-and-forget:** when the front panel button is pushed, the current SOP is stored and maintained, even if polarization changes occur at the instrument input
- **Defined Stokes:** the target output SOP can be defined by the user using the Stokes parameters

The polarization navigator also has a convenient button to quickly change from a manually adjusted SOP to the corresponding orthogonal state, as can be used to check extinction ratio.

8169A Polarization Controller

The Agilent 8169A polarization controller is based on mechanically rotated waveplates in a free-space collimated beam path. Like the N7786B, this can be used to determinately set any SOP. The output is not determined by an SOP monitor but from the known mechanical positions of the waveplates. The use of zero-order waveplates, optimized at 1540 nm provides very stable SOP vs. wavelength in this region. The slower setting of the 8169A does not support the single-sweep Mueller matrix measurement of PDL, but is used together with the N4150A PFL software to measure PDL using 4 sweeps of the tunable laser at 4 different SOP to the device under test. The linear polarizer at the instrument input stabilizes the output SOP against input changes and also provides polarized output from unpolarized light sources. Built-in algorithms provide a scanned pattern over the Poincaré sphere and enable the transition path from one state of polarization on the Poincaré sphere to another to be specified along orthogonal great circles.

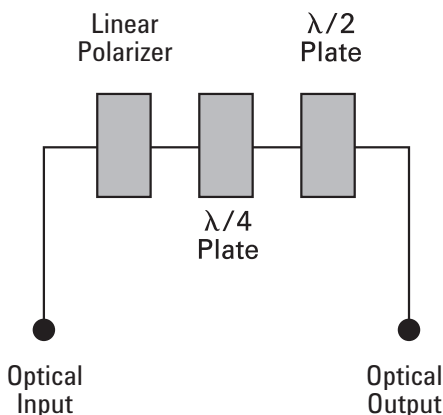

8169A block diagram

Web Link

www.agilent.com/find/pol

86142B
86146B
86120B
86120C
86122A

- Filter mode
- Excellent wavelength accuracy and low polarization dependence
- 90 dBm sensitivity and 90 dB dynamic range
- Flexible monochromator output model
- Applications with automatic pass/fail checking
- High resolution at highest speed allows fast spectral characterization (high resolution spectral analysis in 1440 to 1640 nm)

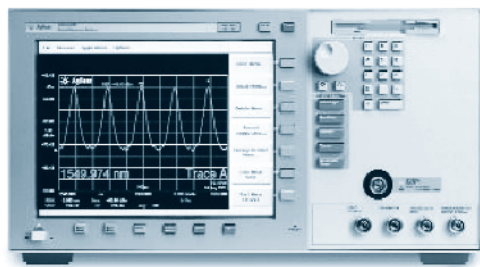

86146B

86142B and 86146B Optical Spectrum Analyzers

The Agilent 8614xB family of grating-based optical spectrum analyzers displays the amplitude of light versus wavelength over a 600 to 1700 nm wavelength range. The OSA uses a patented double-pass monochromator design to simultaneously achieve high sensitivity and dynamic range with a fast sweep time. This is key for characterizing DWDM components and multiple channel systems, especially in a manufacturing environment where speed, accuracy and throughput are critical.

The Agilent 8614xB family of optical spectrum analyzers features trace-math functions for up to six traces. Four markers allow for easy measurement of wavelength separation (GHz or nm), power density and optical signal-to-noise ratio. The following applications currently come with the instrument:

- Passive component test application
- WDM test application
- Amplifier test application
- Source test application

Filter Mode and Channel Drop

In filter mode, available with the 86146B, the light from the grating monochromator is directed to a single-mode fiber optical output from the instrument. The monochromator can be swept or set to a fixed wavelength, with adjustable resolution bandwidth.

One of the features of filter mode is to allow a single channel to be isolated from a tightly spaced DWDM signal for additional analysis. The wavelength or channel dropped out can then be quantitatively analyzed in the time domain.

Time Resolved Chirp

A second feature of Agilent's filter mode is the ability to measure time-resolved chirp (TRC), the instantaneous optical frequency deviation versus time. Characterizing TRC enables lower cost lasers to be used in DWDM components. The TRC is measured using the 86146B OSA and the 86100C digital component analyzer with an optical module. The software includes the dispersion penalty calculation (DPC) routine, which can be used to qualify transmitters for the distance over which they can be used. DPC is an alternative to measuring dispersion penalty using a bit error ratio setup.

Web Link

www.agilent.com/find/osa

- Wavelength accuracy up to ± 0.2 ppm, ± 0.3 pm referenced to 1550 nm
- Wavelength resolution up to 5 GHz
- Measure average wavelength and total power
- Simultaneously measure wavelengths and powers of up to 1000 channels
- Automatic optical signal-to-noise ratio measurements
- Automated measurement routines and data logging



86122A multi-wavelength meter

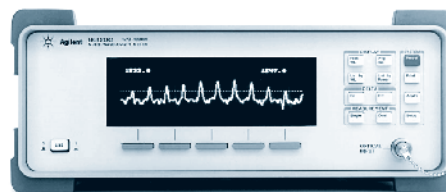

86120B multi-wavelength meter

86120B, 86120C and 86122A Multi-Wavelength Meters

The Agilent family of multi-wavelength meters uses advanced digital processing to differentiate and measure up to 1000 discrete wavelengths and their amplitude (1000 for 86122A, 200 and 100 for the 86120C and B, respectively).

The 86122A multi-wavelength meter is optimized for measuring ultra-dense channel spacing, an ideal solution for the design and manufacturing of next-generation optical networks.

Legendary for their rugged design that withstands shocks and vibrations, the 86120B and 86120C multi-wavelength meters are ideal for optical network commissioning and monitoring applications, suitable for DWDM systems with channels spaced at < 50 GHz.

Test of WDM Transmission Systems

Built-in analysis functions address a range of transmission system tests:

- Optical Signal-to-Noise Ratio (OSNR) and averaged OSNR for WDM SONET/SDH systems
- Drift of wavelength and amplitude
- Data logging and monitoring of dynamic changes
- Verification of channel spacing and cross talk

Test of Laser and Light Sources

A multitude of measurement and analysis routines addresses the evaluation, burn-in test, incoming inspection and final test of light sources:

- Center wavelength and amplitude measurement and monitoring of single and comb sources
- Special broadband algorithm for the test of LEDs or Bragg-grating filtered ASE sources
- Fabry-Perot laser characterization by total power, Full-width at half maximum, mean wavelength and mode spacing (86120C and 86122A only)
- Coherence length of Fabry-Perot lasers for CD-ROM drives or datacom systems (86120B only)

Web Link

www.agilent.com/comms/mwm

- 40/100G coherent transmission test
- Advanced research for 400 Gbit/s to 1 Tbit/s
- Coherent transmitter characterization
- Coherent transmission link test
- Highest true analog bandwidth
- Error vector analysis capabilities

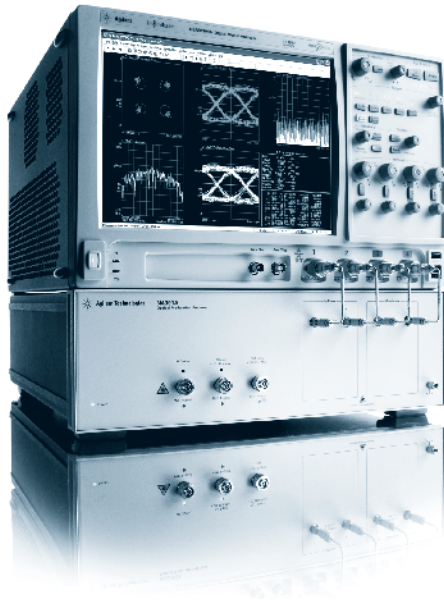

Unlike the high-speed optical networks of the past, where modulating an optical wave's amplitude on and off at high-rates was sufficient, today's optical links are following the wireless industry's lead to high order modulation formats. Complex modulation formats extend beyond on-off keying by encoding communication symbols with both amplitude and phase information. The N4391A optical modulation analyzer is optimized for analysis of this kind of now optical modulation formats. It supports transmission rates of 40/100 G and beyond. The N4391A is the ideal instrument for advanced research on higher than 112 Gbit/s transmission speeds.

Characterization of the signal quality of a vector modulated signal right at the transmitter output or along the link is the core application of this kind of instrument. Most important analysis and measurement tools are:

- Optical constellation diagram
- Error vector magnitude (EVM)
- Phase error
- BER on physical layer
- CD, 1st order PMD compensation and measurement
- Quadrature error
- IQ imbalance
- I or Q eye diagram
- High resolution spectrum
- Spectrogram of many analysis tools
- Laser line width
- Polarization of analyzed symbols
- Support of more than 30 modulation formats
- Adaptive equalization
- Frequency offset
- Variable phase tracking bandwidth

Key performance data in combination with two with 90000-X Series scopes

N4391A

- Up to 32 GHz true analog system bandwidth
- Up to 60 Gbaud symbol rate
- Up to 240 Gbit/s analysis for DP-DQPSK
- Up to 64 GHz spectral analysis span
- 700 fs rms jitter between scopes

Features and Benefits

- Wide-bandwidth time-domain polarization-diverse coherent optical receiver, for state-of-the art advanced modulation format analysis
- Specifications for instrument performance
- Very easy user performable performance verification within minutes for highest reliability of your test results
- Real-time sampling for optimal phase tracking
- Highest flexibility, with numerous modulation formats, analysis tools and instrument configurations
- In-depth analysis of optical transmitters and links with new analysis tools, such as constellation diagram with masks and error vector analysis
- Optical constellation diagram with quantitative description of constellation errors for precise description of the transmitter, making test results comparable
- Full support of DQPSK/QPSK with polarization multiplexed signals
- No clock input or hardware clock recovery necessary
- Long pattern analysis available depending on selected data storage option
- Real-time high resolution spectral analysis
- Laser line width measurement
- Bit error analysis, even with polarization multiplexed signals
- Flexible hardware and software concept for future adoption to new requirements and investment protection
- CD and first order PMD measurement and compensation for link tests with vector modulated signals

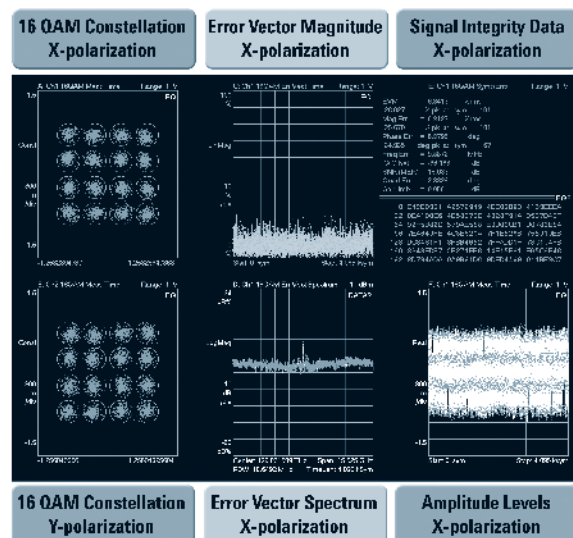

Web Link

www.agilent.com/find/oma

N4373C
N4374B
N4375B
N4376B

- High confidence and fast time-to-market with a NIST-traceable turn-key solution
- Improves the yield of development and production processes
- Excellent accuracy and reproducibility
- Measurement results can be compared among test locations world wide
- Significantly increased productivity using the fast and easy measurement setup with a unique new calibration process leads to lower cost of ownership



Agilent's N437xB/C lightwave component analyzer (LCA) is the instrument of choice to test most advanced high speed electro-optical components for CATV, 10G/40G/100G transmission. Modern optical transmission systems require fast, accurate and repeatable characterization of the core electro-optical components, the transmitter, receiver, and their subcomponents (lasers, modulators and detectors), to guarantee performance with respect to modulation bandwidth, jitter, gain, and distortion.



A unique new calibration concept significantly reduces setup time to a maximum of several minutes, depending on the selected measurement parameters. This results in increased productivity in R&D or on the manufacturing floor. The fully integrated "turn-key" light wave component analyzer (LCA) helps reduce time to market, compared to the time-consuming development of a selfmade setup. By optimizing the electrical and the optical design for lowest noise and ripple, the accuracy has been improved by better than a factor of 2 compared to legacy systems. This increased accuracy improves the yield from tests performed with the N437xB/C Series by narrowing margins needed to pass the tested devices. Using the advanced measurement capabilities of the network analyzer, all S-parameter related characteristics of the device under test, like responsivity and 3 dB-cutoff frequency, can be qualified with the new Lightwave Component Analyzer from 10 MHz to 67 GHz.

Applications

These components significantly influence the overall performance of the transmission system with the following parameters:

- 3 dB bandwidth of the electro- optical transmission
- Relative frequency response, quantifying how the signal is transformed between optical and electrical or input and output versus modulation frequency
- Absolute frequency response, relating the conversion efficiency of signals from the input to the output
- Electrical reflection at the RF port
- Group delay of the opto-electronic component

Only a careful design of these electro-optical components over a wide modulation signal bandwidth guarantees successful operation in the transmission system.

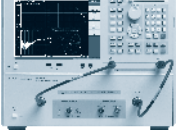
Product	Fiber output	Frequency range	Transmitter wavelength	Frequency range
	Single-mode	10 MHz – 67 GHz 10 MHz – 50 GHz 10 MHz – 40 GHz	1550 nm 1310 nm 1290 – 1610 nm external	±0.8 dB @ 50 GHz ±1.3 dB @ 65 GHz
	Single-mode	10 MHz – 26.5 GHz	1310 nm 1550 nm 1290 – 1610 nm external	±0.5 dB @ 20 GHz
	Multimode	10 MHz – 26.5 GHz	850 nm	±1.0 dB @ 20 GHz
	Single-mode	100 kHz – 4.5 GHz	1310 nm 1550 nm 1290 – 1610 nm external	±0.6 dB @ 4.5 GHz

Web Link

www.agilent.com/find/lca

N4371A RIN Measurement System

- Accurate, high-speed and easy measurements of RIN frequency characteristics
- Reduced uncertainty by using Agilent original characterization technique
- High-speed measurement (5 seconds or less for 20 GHz span, 2000 points 10X average)
- Analysis on multiple traces with variety of markers

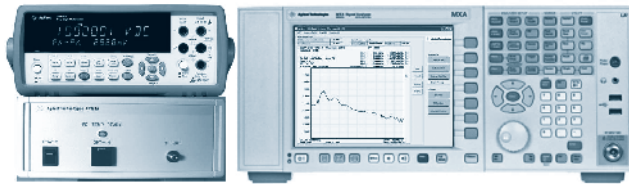

N4371A RIN Measurement System

Agilent provides an accurate, high-speed and easy-to-use spectral RIN measurement system by integrating a sensitive, low-noise optical receiver, an industry-standard X-Series spectrum analyzer and a digital multimeter.

RIN (Relative Intensity Noise) is a parameter representing temporal intensity fluctuations of a laser signal and is used to characterize the noise of laser devices. RIN is an indispensable specification for indicating the signal quality of both digital and analog optical transmission systems.

The N4371A Agilent RIN measurement system provides accurate RIN measurements with a specially developed characterization technique. Agilent's RIN measurement system also reduces uncertainties by precisely removing the interference from thermal noise and shot noise. The measurement time is less than 5 seconds with 20 GHz frequency span, 2,000 frequency points and 10 averages. The high-speed measurement enables a real-time observation of RIN frequency characteristics with varying parameters of the DUT. The user interface of the N4371A is easily accessible from the spectrum analyzer display.

The RIN measurement system provides accurate, fast and easy RIN measurement to a very low RIN value of -160 dB/Hz or less, in a wide frequency range from 10 MHz to 20 GHz. The smoothing aperture is selectable from 0 to 10% for displaying the measurement results. This function achieves a high resolution RIN evaluation with small smoothing aperture, which shows the full frequency dependence of the RIN characteristics.



81490A Reference Transmitter

- Highly repeatable and reproducible measurements for narrower test margins, better yield and improved device specifications
- Support for full compliance to IEEE 802.3ae stressed eye test in combination with the N4917A optical receiver stress test solution
- Wide extinction ratio range enables test of devices under all target operating conditions
- Dual-wavelength 1310 nm and 1550 nm transmitter built-in for rapid remote or manual reconfiguration

81495A Reference Receiver

- Clean eye for best loop back performance in transceiver test
- Low noise and low jitter for reliable stressed eye testing
- Compliance to IEEE 802.3/10 GFC stressed eye test in combination with the N4917A optical receiver stress test solution
- Optical average power meter integrated for quick signal level verification and diagnosis



81490A



81495A

81490A Reference Transmitter

Agilent's 81490A reference transmitter offers excellent eye quality as a reference for testing 10 GbE-LR and 10 Gb-ER according to IEEE 802.3ae and according to 10 GFC Fibre Channel specifications. Only the separation of the signal source and the modulator offers zero-chirp modulation. Combined with an appropriate clean external source this ensures compliance with the requirements of the IEEE standard.

- Extinction ratio: ER 1 ... 10 dB
- Rise and fall times: t_r, t_f (80/20) < 30 ps
- Vertical eye closure penalty: VECP < 0.5 dB
- Jitter: < 0.2 UI
- Relative intensity noise (RIN): RIN < -136 dB/Hz
- Modulation bandwidth: 35 GHz
- Unmodulated optical output power: P_{out} > 4 mW

81495A Reference Receiver

Agilent's 81495A reference receiver is designed for testing transceiver loopback according to IEEE 802.3/10 GFC. Here, the optical return signal of the transceiver is fed back to a bit error ratio tester's (BERT's) electrical input. The performance of this O/E conversion has significant influence on the results of the loopback test. The 81495A reference receiver works perfectly with the N4917A optical transceiver stress test solution. Like the 81490A, the module is fully integrated into the LMS 816xB platform.

- Conversion gain: > 400 V/W
- Conversion bandwidth: $f_{3dB el}$ > 9 GHz
- Wavelength range: 750 – 1650 nm
- Measurement range of optical power meter: +3 ... -30 dBm
- RF output coupling: DC
- Fiber output: SMF 9/125 μ m

Web Link

www.agilent.com/find/rin
www.agilent.com/find/ref

N4371A
 81490A
 81495A

Optical Head Adapters

These adapters are to be used with Agilent optical heads only. The connector adapters are needed to attach connectorized fibers. Optical head adapters with integral D-shape for 8162xx optical head (except 81628B – see threaded version):

- 81001FA** FC/PC, FC/APC
- 81001KA** SC
- 81001LA** LC/F3000
- 81001PA** E2000
- 81001MA** MU
- 81003TD** MTP (for female connectors only)
- 810001ZA** blank adapter

Optical head adapters with threaded version for 81628B optical heads:

- 81000FA** FC/PC, FC/APC
- 81000KA** SC
- 81003LA** LC/F3000
- 81000PA** E2000
- 81000VA** ST

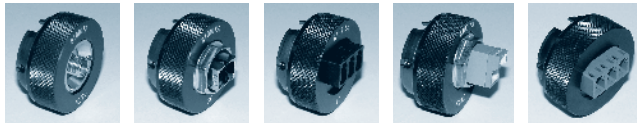

81001FA 81001KA 81001LA 81001PA 81001MA

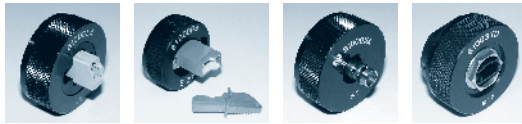

81003LA 81000PA 81000VA 81003TD

Connector adapter for optical heads

81624DD D-shaped adapter to be used with the Agilent 8162xx optical heads except 81628B. For use with threaded adapters.

Optical Connector Interface

Used with Agilent lightwave instruments and modules. Not to be used with optical heads. These flexible connector interfaces can be exchanged by the user and allow easy cleaning of instrument front-end interfaces. Optical connector interface for straight and angled, physical and non-physical contact. All connectors are available for straight and angled connection, unless otherwise noted.

- 81000FI** FC/PC (wide key)
- 81000NI** FC/APC (narrow key)
- 81000KI** SC
- 81000LI** LC/F3000 physical contact
- 81002LI** LC/F3000 sensor modules only
- 81000HI** E2000 physical contact
- 81000PI** E2000 sensor modules only
- 81000MI** MU physical contact
- 81002MI** MU sensor modules only
- 81000VI** ST

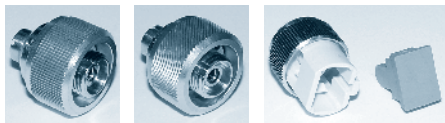

81000FI 81000NI 81000KI

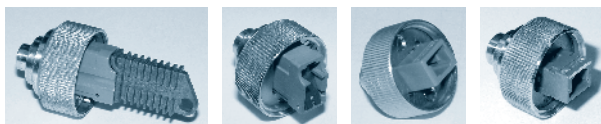

81000LI 81002LI 81000MI 81002MI

81000BC bare fiber connectivity set for 81623B, 81624B and 81626B (1x head adapter, 1x 0-400 μm fiber holder, 1x 400-900 μm fiber holder, 1x gauge)

81000BI bare fiber connectivity set for 81630B and 81634B (1x sensor adapter, 1x 0-400 μm fiber holder, 1x 400-900 μm fiber holder, 1x gauge)

81004BH bare fiber holder set (10x 0-400 μm fiber holder)

81009BH bare fiber holder set (10x 400-900 μm fiber holder)



Universal Through Adapter

In combination with an Agilent 81000xl connector interface, this adapter allows you to mate an HMS-10 connector to another HMS-10, FC/PC/SPC, APC, DIN, ST, E-2000, or SC connector. It can also be used to mate an Agilent 81000BR reference reflector to a patchcord. The Agilent 81000UM is a through-adapter only. It can not be used at the fiber interfaces of the modules.

81000UM universal through adapter

Reference Reflector

81000BR reference reflector

A gold-plated HMS-10 connector for use in calibrating return loss. Return loss is 0.18 dB ± 0.1 dB (96% ± 2%)

81610CC calibrated reflection patchcord for use in calibrating return loss and front-panel offset in return loss measurements

Web Link

www.agilent.com/find/octaccessories



Atomic Force Microscopes

Agilent Technologies offers a wide range of high-precision atomic force microscopes (AFM) to meet your unique research needs. These highly configurable instruments allow you to expand the system's capabilities to meet your needs as they occur. Industry-leading environmental/temperature systems and fluid handling enable superior control for electrochemistry, polymer, material science and life science applications. Agilent offers a broad array of scanners, from 1 micron to 90 microns, with top-down scanning that protects electronics and piezo elements from damage caused by liquid or harsh imaging environments. Furthermore, Agilent's innovative nose cones make changing imaging modes quick and easy. Agilent delivers exceptional worldwide support, provided by experienced AFM application scientists and technical service personnel, giving you the assistance necessary for your research.

Key AFM Accessories

Among the most useful of all of Agilent's AFM accessories is MAC mode. This patented option provides industry-leading performance for in-fluid and soft-sample imaging, allowing you to capture submolecular structures that cannot be resolved with any other AFM technique. Advanced MAC mode III provides three lock-in amplifiers and allows single-pass imaging concurrent with Kelvin force microscopy (KFM) and electric force microscopy (EFM). It also supports the use of higher resonance modes of the AFM cantilever, enabling higher harmonics and the collection of additional information about mechanical properties of the sample surface.

Another important AFM accessory is Agilent's exclusive scanning microwave microscopy (SMM) mode, the first and only technique to combine the calibrated, compound electrical measurement capabilities of a microwave vector network analyzer with the high spatial

resolution of an atomic force microscope. This mode enables complex impedance (resistance and reactance), calibrated capacitance, calibrated dopant density, and topography measurements.

Agilent also offers the PicoTREC molecular recognition tool kit, which lets you quickly distinguish between species that may or may not be engaged in molecular binding events. Additional AFM accessories include an industry-leading environmental isolation chamber (EIC), open- and closed-loop multipurpose scanners, interchangeable nose cones, and purpose-designed sample plates.

Atomic Force Microscopes

Model	Sample size (mm x mm)	Applications	Page
5100	20 x 20	Electrochemistry, polymers, materials science	312
5420	20 x 20	Electronic materials, polymers, materials science, surface characterization, education	312
5500	20 x 20	Electrochemistry, polymers, nanolithography, nanografting, life science, materials science	313
5600LS	200 x 200	Electronic materials, semiconductor, data storage, materials science, polymers	313
6000ILM	Sample plate dependant	Cell membranes, single DNA/RNA, individual proteins, single molecules, biopolymers, surface structure of cells	314

Web Link

www.agilent.com/find/nano

N9420A
N9498S

- High-performance AFM designed for multiple-user labs and educational environments
- Cost-effective, modular solution offers easy upgrade path
- Single multipurpose scanner with interchangeable nose cones makes setting up and switching imaging modes quick and simple
- Online training available to assist new users
- Rigid mechanical design provides low noise floor for sub-nanometer resolution
- Several sample-handling plates available to simplify sample preparation

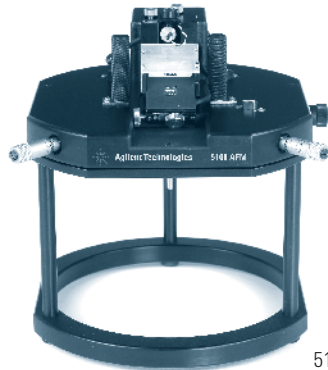

5100 AFM

N9420A 5100 Atomic Force Microscope

The Agilent 5100 AFM is a high-resolution system that provides excellent imaging capabilities in an easy-to-upgrade package. The 5100 offers researchers many of the same features as Agilent's sophisticated 5500 AFM at an entry-level price. It is ideal for polymer, general surface characterization, and materials science applications. The 5100 delivers atomic-scale resolution as well as direct video access to the scan area. The 5100 comes with Agilent's multipurpose scanner for outstanding versatility.

Exceptional Performance

The open-top design of the multipurpose scanner allows high-resolution video microscopy straight down the optical axis. The 5100 can be used with a standard high-performance video microscope without compromising the quality of results. Many video options are available for high-quality color imaging of the scan area. Combined with Agilent's unique microtranslation, the 5100 becomes a state-of-the-art video microscope and micropositioner.

Options and accessories

- Liquid cells
- Electrochemical SPM
- Environmental control
- Vibration isolation
- Glove box
- Break-out box
- Video microscope
- Multipurpose scanners
- Nose cones
- MAC mode
- MAC mode III
- Temperature control
- Sample plates

Imaging modes

- STM
- LFM
- KFM
- EFM
- MFM
- MAC mode
- MAC mode III
- Contact mode
- Phase imaging
- Current sensing
- Force modulation
- Acoustic AC mode

Ordering Information

Email: AFM-SALES@agilent.com

- Scientific-grade instrument delivers atomic resolution
- New design provides improved performance
- SMM allows highly sensitive calibrated electrical and spatial characterization
- New electronics and techniques offer high-resolution KFM, EFM, and PFM
- Cost-effective platform offers simple upgrade path
- Excellent educational instrument with course curriculum



5420 AFM

N9498S 5420 Atomic Force Microscope

The Agilent 5420 AFM is based on the popular Agilent 5400 AFM, the 5420 has been re-engineered for lower noise, better performance, and greater versatility. Featuring a new ergonomic design and improved electronics, this scientific-grade microscope delivers atomic-scale resolution at a remarkably affordable price. The 5420 offers a simple cost-effective upgrade program that includes choice of open-loop and closed-loop scanners, STM scanner, MAC mode, MAC mode III, and temperature control.

Exceptional Performance

The 5420 offers advanced new electrical characterization capabilities. One technique, electrical single-pass mode takes full advantage of the 5420's use of new low-noise electronics to enable high-resolution Kelvin force microscopy (KFM), electric force microscopy (EFM), and piezo force microscopy (PFM). In addition, Agilent's unique scanning microwave microscopy mode allows highly sensitive calibrated electrical and spatial characterization.

The 5420 offers educators an exceptional opportunity to introduce their students to many powerful AFM techniques. The microscope will be delivered with an undergraduate course curriculum and samples for teaching labs.

Options and accessories

- Liquid cells
- Vibration isolation
- Break-out box
- Multipurpose scanners
- Nose cones
- MAC mode
- MAC mode III
- Temperature control
- Sample plates
- Pico image software

Imaging modes

- STM
- LFM
- EFM
- MFM
- SMM
- KFM
- MAC mode
- MAC mode III
- Contact mode
- Phase imaging
- Current sensing
- Force modulation
- Acoustic AC mode

Ordering Information

Email: AFM-SALES@agilent.com

Web Link

www.agilent.com/find/nano

- Highly modular system affords utmost flexibility
- Unrivaled environmental and temperature control
- Superior scanning in fluids, gases, or ambient conditions
- High-resolution scanner with large scan range
- Convenient vertical sample approach

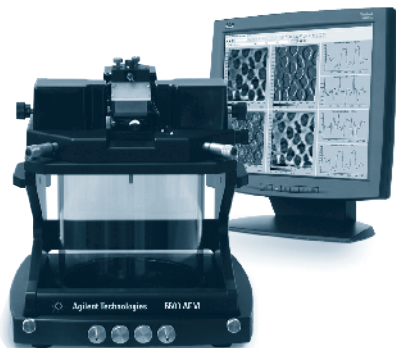

N9410S 5500 Atomic Force Microscope

The Agilent 5500 AFM offers numerous unique features, such as patented top-down scanning and unrivaled environmental and temperature control, while providing maximum flexibility and modularity. The universal microscope base permits easy integration with an environmental chamber or an inverted optical microscope. Sample preparation is made easy with our unique sample plates designed for your application, including imaging in fluids. The 5500's atomic resolution is ideal for electrochemistry, polymers, and soft material applications.

Exceptional Performance

The Agilent 5500 AFM is the ideal multiple-user research system. The intelligent, modular design of the 5500 permits simple integration of a large sample stage, numerous imaging modes, an electrochemistry kit, and a video microscope. Agilent's multipurpose, top-down scanners come in a range of sizes, both open- and closed-loop, all offering outstanding linearity, accuracy, versatility, and ease of use. These scanners are perfect for imaging in fluids or air and under controlled temperature and environmental conditions.

Agilent's industry-leading environmental isolation chamber mounts directly to the 5500 microscope and provides a hermetically sealed sample compartment that is completely isolated from the rest of the system. Agilent's electrochemical SPM option includes a complete kit for high-resolution *in situ* EC-SPM experiments.

Options and accessories

- Liquid cells
- Electrochemical SPM
- Environmental control
- Vibration isolation
- Glove box
- Break-out box
- Video microscope
- Multipurpose scanners
- Nose cones
- MAC mode III
- PicoTREC
- Temperature control
- Sample plates
- Pico image software

Imaging modes

- STM
- LFM
- EFM
- MFM
- KFM
- MAC mode
- MAC mode III
- Contact mode
- Phase imaging
- Current sensing
- Force modulation
- Acoustic AC mode

Ordering Information

Email: AFM-SALES@agilent.com

- Fully addressable and programmable 200 mm x 200 mm stage
- Atomic-resolution imaging of a small sample area
- SMM allows highly sensitive calibrated electrical and spatial characterization
- Allows simple point-and-shoot AFM imaging based on optical view
- Motorized optical focus provides excellent ease of use
- Accurate location mapping (0.5 μm precision) ensures reproducibility

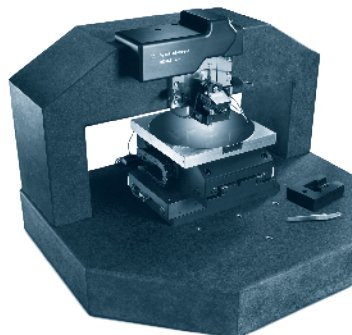

N9480S 5600LS Atomic Force Microscope

Regardless of sample size, the Agilent 5600LS large-stage AFM is ready to deliver high-resolution results. The versatile 5600LS is the world's only commercially available AFM that allows imaging of both large samples (in air) and small samples (in air, or in liquid under temperature control) with a 9 μm x 9 μm AFM or STM scanner. The 5600LS utilizes a fully addressable 200 mm x 200 mm stage and a new, low-noise design.

Exceptional Performance

The 5600LS is perfect for many nanotechnology applications, including semiconductor, polymer and materials science studies. Its programmable, motorized stage enables fast, accurate probe positioning for imaging and mapping large and small specimens. Investigators can precisely locate and identify an area of interest and, with the coordinates stored, automatically reposition the sample quickly and accurately for further study. Samples up to 8" in diameter and 30 mm tall are easily accepted by the vacuum chuck. The stage accommodates a 300 mm wafer with repositioning.

Additionally, Agilent's unique scanning microwave microscopy (SMM) mode allows highly sensitive calibrated electrical and spatial characterization.

Options and accessories

- Acoustic isolation chamber (AIC)
- Liquid cells
- Break-out box
- Multipurpose scanners
- Nose cones
- MAC mode III
- Temperature control
- Sample plates
- Pico Image software

Imaging modes

- STM
- SMM
- LFM
- EFM
- MFM
- KFM
- MAC mode
- MAC mode III
- Contact mode
- Phase imaging
- Current sensing
- Force modulation
- Acoustic AC mode

Ordering Information

Email: AFM-SALES@agilent.com

Web Link

www.agilent.com/find/nano

N9436S

- Easy-to-use solution integrates ILM and AFM capabilities
- Simple point-and-shoot AFM imaging based on optical view
- High-precision overlays of light microscopy and AFM images
- Motorized stage directs movement of sample beneath AFM tip
- Computer-controlled laser with automated photodetector alignment
- Nanoscale resolution without special sample preparation requirements
- Molecular imaging, live-cell imaging, force studies, and mechanical stimulus studies

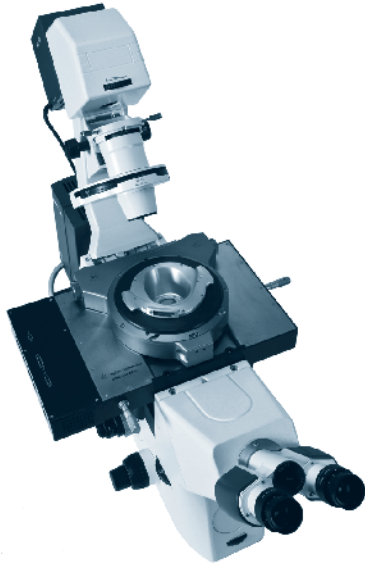

N9436S 6000ILM Atomic Force Microscope

The Agilent 6000ILM AFM seamlessly integrates the capabilities of an atomic force microscope with those of an inverted light microscope or a confocal microscope, letting life science researchers go beyond the optical diffraction limit to achieve nanoscale resolution without any special sample preparation. The 6000ILM is ideal for studying cell membranes, the surface structure of cells, single DNA/RNA strands, individual proteins, single molecules, and biopolymers.

Exceptional Performance

The 6000ILM extends the capabilities of optical microscopes by allowing molecular imaging, live-cell imaging, force studies, and mechanical stimulus studies to be conducted with a single-system solution, all while preserving an efficient, natural workflow. The 6000ILM utilizes a computer-controlled laser with automated photodetector alignment and offers simple point-and-shoot AFM imaging based on an optical image. A high-stability, low-noise motorized stage directs the movement of the sample beneath the AFM tip for measurement.

Researchers can perform fluorescence or DIC imaging simultaneously with AFM imaging and quickly create high-precision overlays of the resultant images. The 6000ILM facilitates high-resolution topography and mapping, the ability to collocate points of interest sequentially, and the acquisition of more detailed information about a sample's structure and material property domains. Additional advantages include patented MAC mode for unrivaled in-liquid imaging, PicoTREC for real-time molecular recognition imaging, and force spectroscopy for experiments such as protein unfolding.

Agilent sample plates provide superior stability as well as easy sample loading. Agilent sample holders are thin (~170 μm cover glass) to facilitate light microscopy, yet very stable to allow high-precision AFM imaging. Simple mounting of 35 mm Petri dishes and liquid cells is supported. Heating control is available from ambient to 80 $^{\circ}\text{C}$ with 0.1 $^{\circ}\text{C}$ precision.

Options and accessories

- MAC mode
- MAC mode III
- Contact mode
- PicoTREC
- Temperature control
- Sample plates
- Pico image software

Imaging modes

- LFM
- MAC mode
- MAC mode III
- Contact mode
- Phase imaging
- Acoustic AC mode

Ordering Information

Email: AFM-SALES@agilent.com

Web Link

www.agilent.com/find/nano

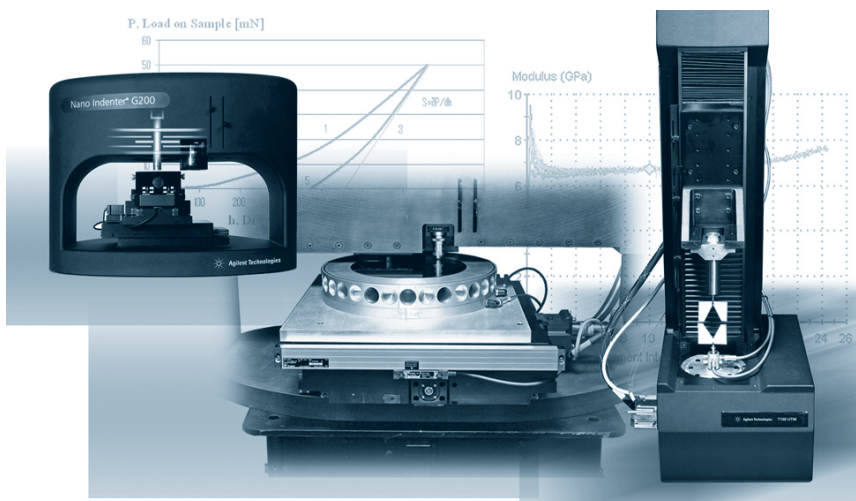

Nanomechanical Test Systems

The culmination of decades of research and development, Agilent Nano Indenter systems are the world's most accurate, flexible, and user-friendly instruments for nanoscale mechanical testing. The pedigree of this nanomechanical test instrumentation is truly impressive. For instance, the seminal paper authored by Warren Oliver and George Pharr has now surpassed 5,000 citations, making it the most frequently cited paper in MRS for mechanical properties of materials. Every Agilent nanomechanical test solution is backed by a team of knowledgeable application scientists and technical service personnel, all of whom strive to provide outstanding support around the world.

Advanced Technologies

Nanoindentation experiments rely on the accuracy of the fundamental load and the displacement data, requiring the highest precision control of load applied to the sample. Agilent Nano Indenters are powered by electromagnetic actuation-based force transducers to ensure precise measurements. This unique design avoids lateral displacement artifacts, while software compensates fully for any drift in force. Agilent Nano Indenters conform to the ISO 14577 standard, delivering confidence in test accuracy and repeatability.

There are many options and accessories available to enhance the capabilities of your Agilent nanoindentation system or universal testing machine. A modular platform makes these components simple to integrate. Agilent continues to optimize advanced technologies and push performance even

further. The Agilent dynamic contact module II option offers 3x higher loading capability than the original dynamic contact module option. Another popular choice, the Lateral Force measurement option, provides three-dimensional quantitative analysis for scratch testing, wear testing, and MEMs probing. The High Load option expands the load capabilities of Agilent Nano Indenters up to 10 N of force, allowing the complete mechanical characterization of ceramics, bulk metals, and composites.

Agilent T150 UTM users can utilize the continuous dynamic analysis option. This technology offers a direct, accurate measurement of the specimen's stiffness at each point in the experiment, enabling mechanical properties to be determined continuously as the specimen is strained.

Nano Indenters

Model	Useable surface area (mm x mm)	Applications	Page
G200	100 x 100	Semiconductor, thin films, MEMs (wafer applications); hard coatings, DLC films; composite materials, fibers, polymers; metals, ceramics; biomaterials, biology	316
G300	225 x 300	Semiconductor, thin films, MEMs (wafer applications); hard coatings, DLC films; composite materials, fibers, polymers; metals, ceramics; biomaterials, biology	316

Universal Testing Machine

Model	Maximum load	Load resolution	Applications	Page
T150	500 mN (50.8 gm)	50 nN (5.1 µgm)	Yield of compliant fibers and biological materials; dynamic studies of fibers and biological materials; tensile and compression studies of polymers	317

Web Link

www.agilent.com/find/nano

U9830A

- Accurate, repeatable results compliant with ISO 14577 standard
 - Electromagnetic actuation allows unparalleled dynamic range in force and displacement
 - Flexible, upgradeable nanoindentation instrument can be configured for repeatable specific applications
 - Dynamic properties characterization via continuous measurement of stiffness by indentation depth
 - Outstanding software with real-time experimental control, easy test protocol development, and precision drift compensation
- Accurate, repeatable results compliant with ISO 14577 standard
 - Large stage supports specimens with diameters up to 300 mm
 - Full testing automation enables instrument to run unattended
 - Electromagnetic actuation allows unparalleled dynamic range in force and displacement
 - Flexible, upgradeable instrument can be configured for repeatable specific applications or a variety of new applications
 - Dynamic properties characterization via continuous measurement of stiffness by indentation depth

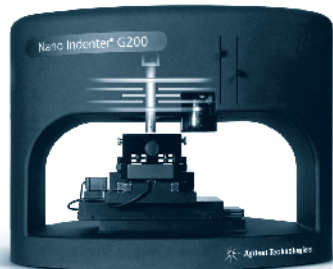

Nano Indenter G200

Nano Indenter G200

The Agilent Nano Indenter G200 is the world's most accurate, flexible, and user-friendly instrument for nanoscale mechanical testing. Electromagnetic actuation allows the G200 to achieve unparalleled dynamic range in force and displacement. The G200 enables users to measure Young's modulus and hardness in compliance with ISO 14577. It also enables measurement of deformation over six orders of magnitude (from nanometers to millimeters). A variety of options can be added to accommodate testing needs.

Exceptional Performance

The capabilities of the Nano Indenter G200 can be extended to facilitate frequency-specific testing, quantitative scratch and wear testing, integrated probe-based imaging, high-temperature testing, expanded load capacity up to 10 N, and customizable test protocols. Users are able to quantify the relationship between structure, properties, and performance of their materials quickly and easily with minimal sample preparation.

The G200 standard configuration utilizes the Agilent XP indentation head, which delivers < 0.01 nm displacement resolution and > 500 μm maximum indentation depth. To extend the range of load-displacement experimentation to the surface contact level, the G200 can be equipped with the dynamic contact module (DCM).

The continuous stiffness measurement (CSM) technique, which is compatible with both the XP and the DCM indentation heads, satisfies application requirements that must take into account dynamic effects, such as strain rate and frequency. The lateral force measurement (LFM) option, which is compatible with the XP head, provides three-dimensional quantitative analysis for scratch testing, wear testing, and MEMS probing.

Options and accessories

- Dynamic contact module II (DCM II)
- Continuous stiffness measurement (CSM)
- Lateral force measurement (LFM)
- High load
- Heating stage
- NanoVision software

Ordering Information

Email: NIO-SALES@agilent.com

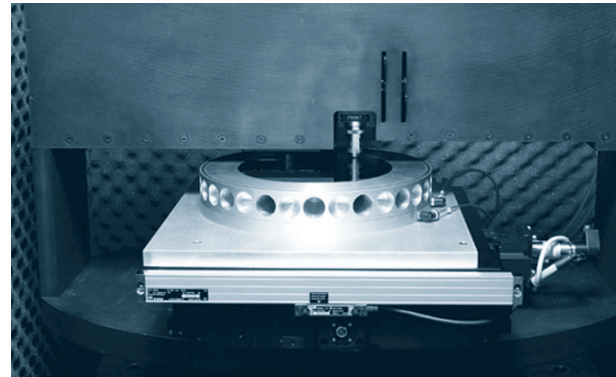

Nano Indenter G300

U9830A Nano Indenter G300

The Agilent Nano Indenter G300 utilizes a stage that supports samples with diameters up to 300 mm. An excellent long-term investment for industrial users, it provides a fast, reliable method for acquiring mechanical data on uncut silicon wafers. The G300 permits testing of multiple layers, facilitating product development and failure analysis, which can have a significant effect on yield, performance, and longevity of devices.

Exceptional Performance

Electromagnetic actuation allows the G300 to achieve unparalleled dynamic range in force and displacement. The G300 enables measurement of Young's modulus and hardness in compliance with ISO 14577. It also enables measurement of deformation over six orders of magnitude (from nanometers to millimeters). Capabilities can be extended to facilitate frequency-specific testing, quantitative scratch and wear testing, integrated probe-based imaging, expanded load capacity up to 10 N, and customizable test protocols.

The standard configuration utilizes the Agilent XP indentation head, which delivers < 0.01 nm displacement resolution and > 500 μm maximum indentation depth. To extend the range of load-displacement experimentation to the surface contact level, the G300 can be equipped with the dynamic contact module (DCM). The continuous stiffness measurement (CSM) technique, compatible with the XP and DCM heads, satisfies applications that must take into account dynamic effects, such as strain rate and frequency.

Options and accessories

- Dynamic contact module II (DCM II)
- Continuous stiffness measurement (CSM)
- Lateral force measurement (LFM)
- High load
- NanoVision software

Ordering Information

Email: NIO-SALES@agilent.com

Web Link

www.agilent.com/find/nano

- **Nanomechanical actuating transducer head functions as a load cell to deliver high sensitivity over a large range of strain**
- **Dynamic properties characterization mode provides precise accuracy throughout testing**
- **Flexible, upgradeable universal testing machine can be configured for repeatable specific applications or a variety of new applications**
- **Outstanding software offers real-time experimental control and easy test protocol development**

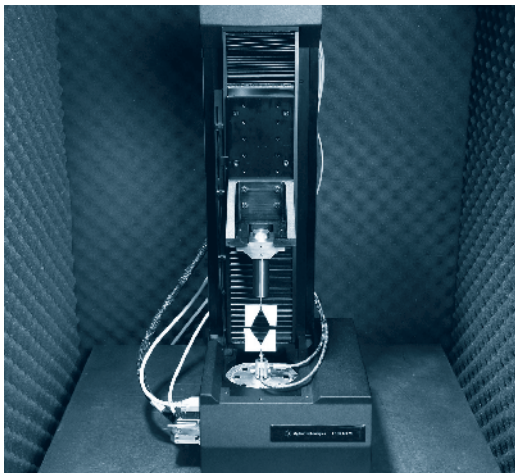

T150 UTM

Options and accessories

- Continuous dynamic analysis (CDA)
- Indentation kit
- NanoSuite explorer

Software

- Every T150 UTM comes with the Agilent NanoSuite 5.0 professional software package. NanoSuite 5.0 lets users run tests and manage data with unprecedented ease. Through the elegant and intuitive interface, users can set up and run experiments quickly – changing test parameters as often as desired – with just a few clicks
- The Agilent NanoSuite 5.0 Explorer software package is offered as a T150 UTM option. The Explorer version of NanoSuite 5.0 enables researchers to write their own NanoSuite methods via a new, easier-to-use, method-creation protocol that reduces the lines of code needed for customized test development

Ordering Information

Email: NIO-SALES@agilent.com

Web Link

www.agilent.com/find/nano

U9815A T150 Universal Testing Machine

The *T150 UTM* (universal testing machine) is a state-of-the-art universal testing machine that offers researchers a superior means of nanomechanical characterization by utilizing a nanomechanical actuating transducer head to produce tensile force. The electromagnetic actuator, combined with a precise capacitive gauge, delivers outstanding sensitivity over a large range of strain. Applications include yield of compliant fibers and biomaterials, dynamic studies of fibers and biomaterials, and tensile and compression studies of polymers.

Exceptional Performance

The T150 enables researchers to understand dynamic properties of compliant fibers via the largest dynamic range in the industry and the best resolution on the market (five orders of magnitude of storage and loss modulus). Additional advantages include fast, accurate generation of real-time test results; improved understanding of strain-rate-sensitive materials and time-dependent response; improved statistical sampling in biomaterials applications; and automated reporting of test results.

The T150 includes a nanomechanical actuating transducer head and a software-controlled, automated handset, as well as a fully automated data acquisition and control system with PC, monitor, keyboard, color inkjet printer, and Agilent NanoSuite 5.0 professional software. The T150 is equipped with a micropositioner stage, a sample guide that ensures the sample is orthogonal and aids in positioning the upper grip. An indentation kit including an inversion footer is available allowing the system to be used as an indenter.

The continuous dynamic analysis (CDA) option offers a direct, accurate measurement of the specimen's stiffness at each point in the experiment, enabling mechanical properties to be determined continuously as the specimen is strained. By measuring both the amplitude and phase relationships between the load and displacement oscillations, CDA makes it possible to determine storage and loss modulus.



GPIB, USB and instrument control products

Agilent GPIB and instrument control products provide fast, reliable and high-performance instrument-to-PC connections. From the legendary GPIB cables to the wide range of interface converters, see how each provides seamless integration to your instruments.

Easy Connection to GPIB, USB and RS-232 Instruments

Agilent GPIB and instrument control products offer simple “plug-and-play” set up and configuration.

Use PC-Standard Interfaces

Connect via your computer PCI/PCIe slot or use the built-in USB or LAN ports on your PC to connect to your instruments.

Choice of Interfaces (GPIB, RS-232, USB, LAN, PCI, PCIe)

Agilent offers you a selection of products to meet your connectivity needs.

Use Industry-Standard I/O Libraries

The included industry-standard VISA I/O libraries make it easy for you to use your existing software programs and let you mix and match test instruments and software from different vendors in a single system.

Choose the Connectivity Product that Best Fit your Needs

For control via instrument GPIB interface

Product	82350B PCI GPIB interface card	82351A PCI express GPIB interface card	82357B USB/GPIB converter	E5810A LAN/GPIB gateway
Best for	Maximum GPIB throughput for all configurations	Maximum GPIB throughput for all configurations	Easiest GPIB connection with plug-and-play configuration	Remote GPIB and RS-232 connections & sharing of instruments in a distributed system
Max. transfer rate	More than 900 KB/s	More than 1.4 Mb/s	More than 1.15 Mb/s	More than 900 KB/s
Max. connected instruments	14 (daisy-chained)	14 (daisy-chained)	14 (daisy-chained)	14 (daisy-chained)
Operating system	Windows XP/Vista/Windows 7	Windows XP/Vista/Windows 7	Windows XP/Vista/Windows 7	Windows XP/Vista/Windows 7
Driver	Agilent IO libraries suite	Agilent IO libraries suite	Agilent IO libraries suite	Agilent IO libraries suite

For control via instrument RS-232 and USB interface

Product	E5805A USB/4-port RS-232 hub	E5813A networked 5-port USB hub
Best for	Easiest RS-232 connection with plug-and-play configuration	Remote USB connections Sharing of instruments in a distributed system
Max. transfer rate	More than 230 KB/s per port	12 MB/s per port
Max. connected instruments	4	5
Operating system	Windows XP	Windows XP
Driver	E5805A driver and Agilent IO libraries suite	E5813A driver and Agilent IO libraries suite

Cables and adapter

	10833x GPIB cables	10834A GPIB-to-GPIB adapter
Features	Durable, reliable connection between two GPIB interfaces Available in multiple lengths: 10833D (0.5 m), 10833A (1 m), 10833B (2 m), 10833C (4 m), 10833F (6 m), 10833G (8 m)	2.3-cm extension from instrument rear panel allows clearance for connectors, switches and cables

Web Link

www.agilent.com/find/gpib

- PCI IEEE-488 interface for PCs
- Transfer rates up to 900 KB/s
- Dual-processor support on Windows XP/Vista/Windows 7
- Interface to 14 GPIB instruments (max)

- Compact half-height size (68.9 mm)
- High transfer rate of 1.4 MB/s
- High flexibility via up – plugging (to x4 or x8 PCIe slots)
- 3.3 V signal level for lower power consumption
- Compatibility with industry standard PCIe rev 1.0a and IEEE-488
- Interface to 14 GPIB instruments (max)

82350B
82351A

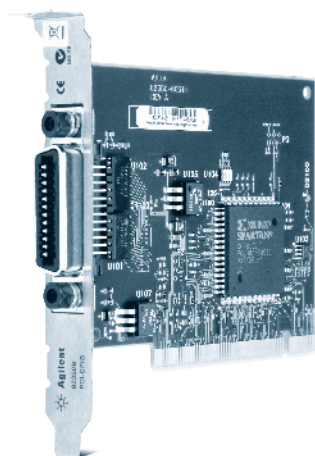

82350B

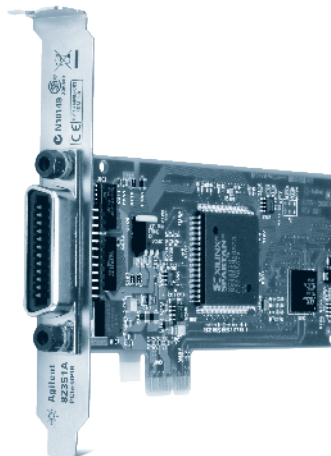

82351A

82350B PCI GPIB Interface Card

High Performance for Manufacturing Test Applications

The 82350B is Agilent’s highest-performance GPIB interface. With a direct PCI computer connection, transaction overhead is minimized for the best overall performance.

The 82350B card de-couples GPIB transfers from PCI bus transfers. Buffering provides connectivity and system performance that is superior to direct memory access (DMA). The hardware is software-configurable and compatible with the plug-and-play standard for easy hardware installation. The GPIB interface card plugs into a 5-volt PCI slot in the backplane of your PC.

Specifications

General requirements

- PCI bus slot: 5-V PCI slot, 32 bits
- Supported standards:
 - PCI rev 2.2
 - IEEE 488.1 and IEEE 488.2 compatible

General characteristics

- Maximum data rate: more than 900 KB/s
- Buffering: built-in
- Configuration: plug-and-play

Ordering Information

82350B high-performance PCI GPIB interface

Web Link

www.agilent.com/find/82350B

82351A High Performance PCIe – GPIB Interface Card

High Transfer Rate for Demanding Test Applications

The Agilent 82351A PCIe – GPIB interface card is designed for integration into next generation PCs or workstations. It offers fast data transmission for various demanding test applications that require data to be transferred to memory fast enough without any loss or overwriting.

Specifications

General requirements

- PCI bus slot: 3.3 V PCIe slot, 32 bits
- Supported standards:
 - PCIe rev. 1.0a
 - IEEE 488.1 and IEEE 488.2 compatible

General characteristics

- Maximum data rate: 1.4 MB/s or better
- Maximum instrument connection: 14 instruments – daisy chain via GPIB
- Buffering: built-in
- Configuration: plug-and-play

Ordering Information

82351A high performance PCIe – GPIB interface card

Web Link

www.agilent.com/find/82351A

82357B
E5805A

- Fast and easy connection to GPIB instruments
- Uses standard USB and IEEE-488 interfaces
- Maximum GPIB transfer rate of more than 1.15 MB/s
- Use industry standard software
- Parallel polling capability



82357B

82357B USB/GPIB Interface

Connect GPIB Instruments Quickly and Easily to your Computer's USB Port

The 82357B USB/GPIB interface provides a direct connection from the USB port on your desktop and laptop computers to GPIB instruments. Once the software is loaded, your computer automatically detects the 82357B when it is connected to the USB port of the computer.

The 82357B is a plug-and-play device. It is also hot-pluggable, making it easy to connect and disconnect without having to shut down the computer. No external power supplies are necessary.

Specifications

General requirements

- Supported standards:
 - Supports USB 2.0 high speed and full speed
 - Standard USB endpoints supported
 - IEEE-488.1 and IEEE-488.2 compatible
 - SICL and VISA 2.2

General characteristics

- GPIB transfer rate: 1.15 MB/s or better
- USB hubs: self-powered hubs
- Parallel polling: a single parallel poll can easily check up to eight individual devices at once, corresponding to the number of data lines on the GPIB
- Cable: 2.5 meters, shielded, connector rated for 1,500 insertions
- LED indicators: READY, ACCESS, FAIL
- Maximum connections: Maximum of 4 converters can be connected to the PC
- Instrument connections: 14 instruments – daisy chain via GPIB
- Configuration: plug-and-play

Ordering Information

82357B USB/GPIB interface

Web Link

www.agilent.com/find/82357B

- Easy connection from standard USB port on your PC to up to four RS-232 instruments or devices
- Fully compatible with Windows COM driver and industry-standard VISA I/O software



E5805A

E5805A USB/4-Port RS-232 Interface

Add Four Serial Ports Within Minutes

The Agilent E5805A USB/4-port RS-232 interface provides a direct connection from the USB port on your notebook or desktop PC to up to four RS-232 instruments or devices. Simply install the driver and plug in the E5805A USB 4-port RS-232 interface to add four RS-232 ports to your computer.

The E5805A is a standard plug-and-play device. Your computer automatically detects and configures it when it is connected to the USB port of the computer. You can interface up to four devices, with baud rates of up to 230 Kb/s per serial port. The E5805A provides four DB9 serial connectors and ships with a 1.8-meter USB cable.

Specifications

General requirements

- Supported standards:
 - USB 1.1 (fully compatible with USB 2.0)
 - EIA-232

General characteristics

- Support for USB hubs: self-powered hubs
- Cable: 1.8 meter USB, USB A (host side) to USB B (device side)
- Maximum data rates: 230 Kb/s per port
- RS-232 baud rates: 300, 1200, 2400, 4800, 9600, 19200, 38400, 57600, 115200, 230400 b/s
- RS-232 flow control: none, RTS/CTS, XON/XOFF, DTR/DSR
- RS-232 parity: none, odd, even, space, mark
- RS-232 bits: 5, 6, 7, 8
- RS-232 stop bits: 1, 2
- RS-232 SRQ interrupts: on RI, DSR, DCD, CTS (using connectivity libraries)
- Maximum instrument connections: 4 RS-232 instruments/devices
- Configuration: plug-and-play
- Indicators: tri-state LED displays device status and COM port activity

Ordering Information

E5805A USB/4-port RS-232 interface

Web Link

www.agilent.com/find/E5805A

- Remote access and control of GPIB and RS-232 instruments via LAN
- Easy set up and use via digital display and Web browser



E5810A

E5810A LAN/GPIB Gateway

Remote Access and Collaboration with GPIB Instruments via your LAN

The E5810A uses DHCP, if available, to automatically configure necessary network parameters, including its IP address. The gateway can be controlled from multiple locations and by multiple users via your LAN, so it is easy to share control of instruments from locations worldwide.

For easy remote access, enter the IP address from the digital display as the URL in your web browser and gain access to connected GPIB and RS-232 instruments. You would be able to use your browser to send instrument commands interactively, and quickly see your measurement results.

With IO libraries suite 15.0 or higher, you are able to program the instruments in all standard development environments.

Specifications

General requirements

- Supported standards:
 - IEEE 488.1 and IEEE 488.2 compatible
 - 10BASE-T/100BASE-TX networks
 - VXI-11 protocol
 - EIA-232

General characteristics

- Maximum data rates:
 - More than 900 KB/s – GPIB port
 - 115 Kb/s – RS-232 port
- RS-232 baud rate: 300, 1200, 2400, 4800, 9600, 19200, 38400, 57600, 115200 b/s
- RS-232 flow control: none, RTS/CTS, XON/XOFF, DTR/DSR
- RS-232 parity: none, odd, even, space, mark
- RS-232 bits: 5, 6, 7, 8
- RS-232 SRQ interrupts: on RI, DSR, DCD, CTS
- Max. instrument connections:
 - 14 instruments – daisy chain via GPIB
 - 1 RS-232 device
 - Up to 16 simultaneous connectivity connections
- Indicators: LEDs for power, activity, fault

Ordering Information

E5810A LAN/GPIB gateway

Web Link

www.agilent.com/find/E5810A

- Maximum connected instruments: 5
- Maximum data transfer rate: 12 Mbps per port
- Fully compatible with USB 1.1, USB 2.0 and 10BASE-T/100BASE-TX standards
- Extend USB devices beyond five meters



E5813A

E5813A Networked 5-Port USB Hub

Connecting Remote USB, GPIB or RS-232 Instruments or Devices via a Standard LAN

The E5813A networked 5-port USB hub uses LAN technology to overcome the 5-meter distance limitation for USB cabling, so you can place USB devices anywhere on a LAN. With access to remote devices, you can collect data, perform measurements, or monitor the progress of your tests. Using the bundled IO libraries suite, you can connect an Agilent 82357B USB/GPIB interface to one of the USB ports for access to GPIB devices. You can additionally connect an E5805A USB/4-port RS-232 interface for access to RS-232 devices.

Specifications

General requirements

- Supported standards:
 - 10BASE-T/100BASE-TX networks
 - USB 1.1 (fully compatible with USB 2.0)

General characteristics

- Output: 5 V DC, 3 A max
- USB device power available: 500 mA per device
- Maximum data rates: 12 Mbps from each port
- Maximum instrument connections: 5 USB instruments or devices
- Configuration: remote LAN configuration utility
- Indicators: LEDs for system and device status

Ordering Information

E5813A networked 5-port USB hub

Web Link

www.agilent.com/find/E5813A

E5810A
E5813A

10833D
10833A
10833B
10833C
10833F
10833G
10834A

10833x GPIB cables

- Durable, reliable connection between two GPIB interfaces
- ### 10834A GPIB-to-GPIB adapter
- 2.3-cm extension from instrument rear panel to allow clearance for connectors, switches and cables

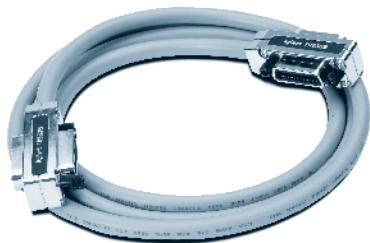

10833x GPIB cable

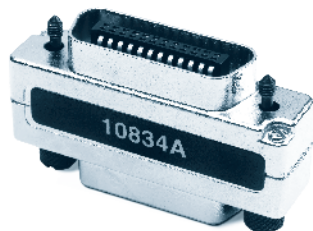

10834A GPIB-to-GPIB adapter

GPIB Cables

Agilent offers a variety of cables that provide easy and reliable connections. These GPIB cables are engineered for exceptional reliability and durability, even under the harshest conditions.

Cable	Length
10833D GPIB cable	0.5 meter
10833A GPIB cable	1 meter
10833B GPIB cable	2 meter
10833C GPIB cable	4 meter
10833F GPIB cable	6 meter
10833G GPIB cable	8 meter

Adapters

10834A GPIB-to-GPIB adapter

The 10834A GPIB-to-GPIB adapter can help when limited rear-panel space and other design considerations make cabling difficult. The 10834A adapter extends the first cable by 2.3 cm away from the rear panel to provide clearance for other connectors, switches and cables.

Ordering Information

- 10833D GPIB cable, 0.5 meter
- 10833A GPIB cable, 1 meter
- 10833B GPIB cable, 2 meter
- 10833C GPIB cable, 4 meter
- 10833F GPIB cable, 6 meter
- 10833G GPIB cable, 8 meter
- 10834A GPIB-to-GPIB adapter

Web Link

www.agilent.com/find/gpib

- **Broad bandwidth with flat frequency response**
- **Low noise floor allows measurements to be made at low signal amplitude**
- **Convenient biasing from Agilent's RF analyzers**

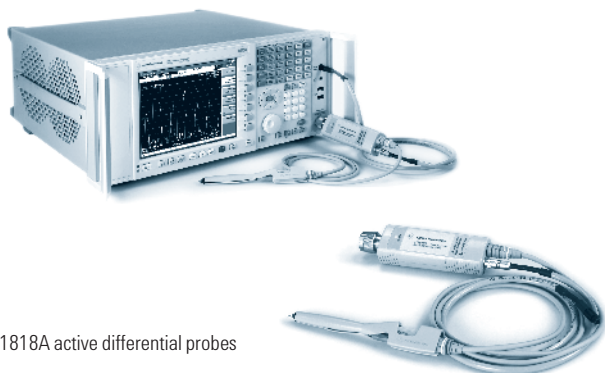

U1818A active differential probes

The Agilent U1818A/B active differential probes make it easy to perform high frequency in-circuit measurements using network, spectrum and signal source analyzers. Designed to be directly compatible with Agilent's RF analyzers, they provide a high-frequency probing solution for R&D and quality assurance engineers performing RF/microwave and high-speed digital design and validation in the wireline, wireless communications and aerospace/defense industries. With flat frequency response, low noise floor and direct power from instrument connection, the U1818A/B active differential probes allow measurements to be made while taking full advantage of Agilent's RF analyzers dynamic range.

U1818A
U1818B

The active differential probes are used with signal and spectrum analyzers providing a probing solution in measuring frequency, power, harmonics and modulation with a large dynamic range. Meanwhile, it is used with signal source analyzers for probing jitter using phase noise measurement technique down to femto seconds of resolution. On the other, probing gain and filter response can be done with the used of the U1818A/B active differential probes with the network analyzers.

Specifications

	U1818A/B with N5381A or N5382A	U1818A/B with N5425A or N5426A	U1818A/B with N5380A
Bandwidth¹		100 KHz – 7/12 GHz	

¹ Normalized 3 dB BW to 100 KHz

Supplementary/Typical Performances

	U1818A/B with N5381A or N5382A	U1818A/B with N5425A or N5426A	U1818A/B with N5380A
Maximum CW input power	16 dBm	16 dBm	14 dBm
Output impedance		50 ohm nominal	
DC biasing characteristic		+15 V @ 142 mA and –12.6 V @ 12 mA	
Maximum DC input voltage		±10 V	
Single ended mode input impedance @ 1 MHz	25 kohm	25 kohm	—
Differential mode input impedance @ 1 MHz	50 kohm	50 kohm	—
Nominal probe attenuation	–10 dB	–10 dB	–6.9 dB
P1dB compression		Input power for < 1 dB compression: 13 dBm @ 7 GHz 11 dBm @ 12 GHz	Input power for < 1 dB compression: 3 dBm @ 7 GHz 0 dBm @ 12 GHz

Agilent recommended signal source analyzer

- **E5052B** SSA signal source analyzer, 10 MHz to 7/26.5 GHz

Agilent recommended signal/spectrum analyzers

- **N9030A** PXA signal analyzer, 3 Hz to 3.6/8.4/13.6/26.5 GHz
- **N9020A** MXA signal analyzer, 20 Hz to 3.6/8.4/13.6/26.5 GHz

Agilent recommended network analyzer

- **E5071C** ENA network analyzers, 9 KHz to 4.5/6.5/8.5 GHz, 100 KHz to 4.5/6.5/8.5 GHz and 300 KHz to 14/20 GHz
- **E5061B** network analyzers, 5 Hz to 3 GHz
- **E5061A** ENA-L RF network analyzers 300 KHz to 1.5 GHz

E2675A differential browser – wide span

- **E2679A** single-ended solder-in
- **E2676A** single-ended browser

Related accessories

- **N1852B** minimum loss attenuator pad
- **N2784A** 1-arm probe positioner
- **N2785A** 2-arm probe positioner
- **N2787A** 3D probe positioner
- **N2880A** in-line attenuator kit
- **N2881A** DC blocking capacitor
- **N5450A** InfiniiMax extreme temperature cable extension

Ordering Information

U1818A 100 kHz to 7 GHz active differential probe

U1818B 100 kHz to 12 GHz active differential probes

U1818A/B-001 cable assembly – power probe cable

U1818A/B-002 cable assembly – banana plug

Probe heads

- **E2695A** differential SMA probe head for InfiniiMax probe
- **N5380A** InfiniiMax II 12 GHz differential SMA adapter
- **N5381A** 12 GHz InfiniiMax differential solder-in probe head
- **N5382A** InfiniiMax II 12 GHz differential browser
- **N5425A** 12 GHz InfiniiMax ZIF-solder-in probe head
- **N5426A** 12 GHz InfiniiMax ZIF tip – kit of 10
- **E2677A** differential solder-in (high loading, high frequency response variation)

Web Link

www.agilent.com/find/RFprobes

M9155C
M9156C
M9157C

A readily scaled integrated switching solution to satisfy your unique platform needs

- Route RF and microwave signals in automated test applications
- Flexibility to build switch matrix as desired, hence a low cost solution
- Peace of mind in switch technology from Agilent who has a proven record for providing, quality switches

Superior RF performance

- 0.03 dB insertion loss repeatability guaranteed throughout the 5 million cycle operating life ensures accuracy of your test results
- Unmatched isolation 92 dB at 8 GHz minimizes cross talk
- Broadband from DC to 26.5 GHz fits most communication and aerospace/defense applications

Reliable and Repeatable switches fit your application

- Exceptional 0.03 dB insertion loss repeatability
- Long life cycles – 5 million cycles guaranteed, 10 million cycles typical

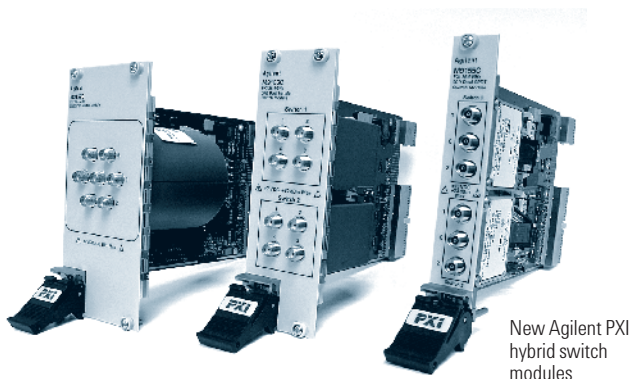

Agilent Technologies – Your One Stop Switching Solution Provider

Agilent has been a leading designer and manufacturer of RF and microwave switches in the global marketplace for more than 60 years. RF and microwave switches are used extensively in microwave test systems for signal routing between instruments and devices under test (DUT).

Agilent designs and manufactures a comprehensive range of RF and microwave switches to meet your switching requirements. Other than connectorized switches, Agilent also offers switch modules that operate across a broad frequency range and come in a variety of configurations. Designed with high accuracy and repeatability for automated test and measurement, signal monitoring and routing applications, Agilent switches have a proven track record for high performance, quality and reliability.

The new Agilent PXI hybrid switch module series operates from a frequency range of DC to 26.5 GHz. Used in applications such as Automatic Test Equipment (ATE), RF communications measurement and RF parametric measurements where a rugged switching module is needed in switching systems.

The PXI hybrid switch module comes in a selection of 3 models; the integration of Agilent dual SPDT switches, dual transfer switches, and a single SP6T configurations. These PXI modules provide an exceptional 0.03 dB insertion loss repeatability, high isolation, low SWR with a long operating life up to 10 million cycles

Specifications

Model	M9155C	M9156C	M9157C
Type	Dual SPDT switches	Dual transfer switches	Single SP6T switch
Slot size	1 slot	2 slots	3 slots
Frequency range	DC to 26.5 GHz	DC to 26.5 GHz	DC to 26.5 GHz
Insertion loss	0.25 + 0.027 GHz DC: 0.25 dB 8 GHz: 0.47 dB 12.4 GHz: 0.58 dB 18 GHz: 0.74 dB 26.5 GHz: 0.96 dB	0.2 + 0.025 GHz DC: 0.20 dB 8 GHz: 0.40 dB 12.4 GHz: 0.51 dB 18 GHz: 0.65 dB 26.5 GHz: 0.86 dB	0.3 + 0.015 GHz DC: 0.30 dB 8 GHz: 0.42 dB 12.4 GHz: 0.49 dB 18 GHz: 0.57 dB 26.5 GHz: 0.70 dB
Isolation	110 – 2.25f (where f is specified in GHz) DC: 110 dB 8 GHz: 92 dB 12.4 GHz: 82 dB 18 GHz: 70 dB 26.5 GHz: 50 dB	110 – 2.2f (where f is specified in GHz) DC: 110 dB 8 GHz: 94 dB 12.4 GHz: 85 dB 18 GHz: 74 dB 26.5 GHz: 57 dB	DC to 12 GHz: 90 dB 12 to 15 GHz: 70 dB 15 to 20 GHz: 65 dB 20 to 26.5 GHz: 60 dB
VSWR	DC to 4 GHz: 1.25 4 to 18 GHz: 1.45 18 to 26.5 GHz: 1.70	DC to 2 GHz: 1.10 2 to 4 GHz: 1.15 12.4 to 20 GHz: 1.40 20 to 26.5 GHz: 1.65	DC to 4 GHz: 1.20 4 to 12.4 GHz: 1.35 12.4 to 20 GHz: 1.45 20 to 26.5 GHz: 1.70
Insertion loss repeatability	0.03 dB	0.03 dB	0.03 dB
Operating life	5 million cycles (guaranteed), 10 million cycles typical	2 million cycles (guaranteed), 5 million cycles typical	2 million cycles (guaranteed), 5 million cycles typical
Connector	3.5 mm (f)	SMA (f)	SMA (f)

Ordering Information

M9155C PXI hybrid coaxial switch, DC – 26.5 GHz, dual SPDT, unterminated

M9156C PXI hybrid coaxial switch, DC – 26.5 GHz, dual transfer

M9157C PXI hybrid coaxial switch, DC – 26.5 GHz, single SP6T, terminated

Web Link

www.agilent.com/find/PXIswitch

- **Low SWR and Insertion Loss**
- **High Isolation – up to 134 dB @ 4 GHz**
- **Long life – 10 million cycles typical**
- **Excellent repeatability of < 0.03 dB guaranteed for 5 million cycles**

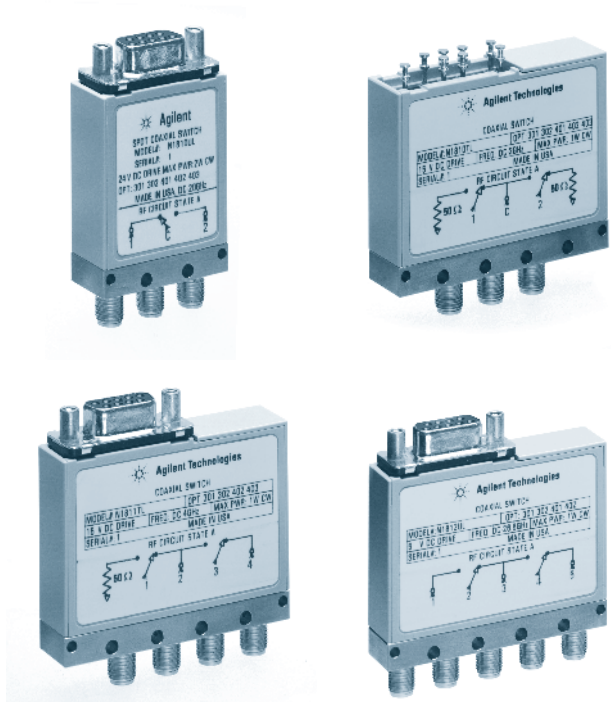

Coaxial Switches

Featuring unparalleled reliability and longest life available, Agilent switches are the clear choice for high volume wireless communications manufacturing test. All switches utilize magnetically latched solenoids and break-before-make RF contacts for test simplicity. In precision measurements and monitoring applications where insertion loss repeatability is crucial, these switches will operate in excess of 5 million cycles with better than 0.03 dB of insertion loss repeatability at 25 °C.

N1810UL – Unterminated Latching SPDT

The N1810UL is a single-pole, double-throw switch available in the frequency range from DC to 26.5 GHz. The switch comes with current interrupts capability.

N1810TL – Terminated Latching SPDT

The N1810TL is a single-pole, double-throw switch available in the frequency range from DC to 26.5 GHz. The unused port is terminated into 50 Ω, making it ideal for applications where source matching is required. The switch comes with current interrupts capability.

N1811TL – Terminated Latching Bypass

The N1811TL is a terminated bypass switch available in frequency range from DC to 26.5 GHz. The switch's internal load can terminate the device under test when in the through mode (up to 1 W). Because of its compact design, it is ideal for drop-in, drop-out applications. The switch comes with current interrupts capability.

N1812UL – Unterminated Latching 5-port

The N1812UL is a versatile, unterminated 5-port switch available in the range of frequency from DC to 26.5 GHz. In bypass switch applications, the fifth port can be terminated externally with a high power termination. It can also be utilized for signal path reversal or as calibration port. The switch comes with current interrupts capability.

General Operating Characteristics: N181x Series

Switching speed	Repeatability	Life	Impedance
< 15 ms	0.03 dB	5 million cycles	50 Ω

Standard Performance Specifications: N181x Series

Isolation (dB)	= 90 – 1.132 x F, where F is specified in GHz				
	DC	4 GHz	12.4 GHz	20 GHz	26.5 GHz
	90	85	76	67	60
Insertion Loss (dB)	= 0.35 + 0.45/26.5 x F, where F is specified in GHz				
	DC	4 GHz	12.4 GHz	20 GHz	26.5 GHz
	0.35	0.42	0.56	0.69	0.8
SWR	DC to 4 GHz				
	4 GHz	12.4 GHz	20 GHz	26.5 GHz	
	1.15	1.25	1.3	1.6	

Optional High Performance Specifications

Isolation (dB)	= 125 – 1.321 x F, where F is specified in GHz				
	DC	4 GHz	12.4 GHz	20 GHz	26.5 GHz
Option 301	125	120	109	99	90
Insertion Loss (dB)	= 0.2 + 0.017 x F, where F is specified in GHz				
	DC	4 GHz	12.4 GHz	20 GHz	26.5 GHz
Option 302	0.15	0.27	0.41	0.53	0.65
SWR	DC to 4 GHz				
	4 GHz	12.4 GHz	20 GHz	26.5 GHz	
Option 302	1.1	1.2	1.23	1.45	

Ordering Information

N1810UL, N1810TL, N1811TL, N1812UL

Frequency

- 004 DC to 4 GHz with SMA(f) RF connector
- 020 DC to 20 GHz with SMA(f) RF connector
- 026 DC to 26.5 GHz with SMA(f) RF connector

Voltage

- 105 5 volts (include Option 402)
- 115 15 volts
- 124 24 volts

DC connector

- 201 D-subminiature 9 pin (f)
- 201 solder lugs

Options

Performance (choose any)

- 301 Higher isolation (see specs)
- 302 low insertion loss and SWR (see specs)

Drive (choose any)

- 401 TTL/5V CMOS compatible drive
- 402 position indicators

Ordering example: For an unterminated 5-port switch, operating up to 20 GHz, with 15 volts coils, D-sub connector, TTL drive, and high isolation, the order should look as follows: **N1812UL-020, -115, -201, -301, -401.**

Web Link

www.agilent.com/find/switches

8762A
8762B
8762C
8762F
8763A
8763B
8763C
8764A
8764B
8764C
8765A
8765B
8765C
8765D
8765F

- Broad operating frequency up to 26.5 GHz
- Low SWR and insertion loss
- High isolation > 100 dB

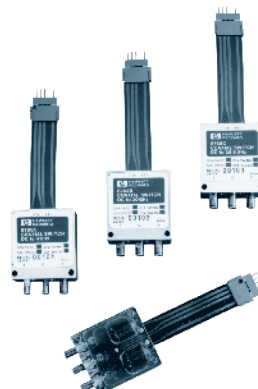
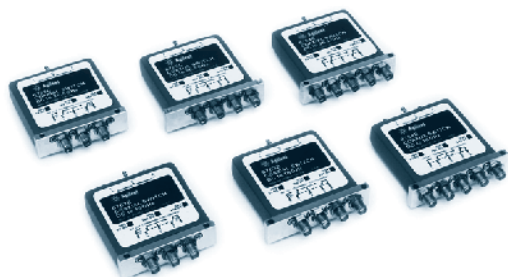

8762 Series

8762A/B/C switches operate up to 26.5 GHz. These switches provide 50 Ω match termination at all ports. Control voltage options T15 and T24 are compatible with TTL/5V CMOS drive circuitry. Another model, 8762F is designed for 75 Ω transmission lines, making it valuable for commercial communication applications up to 4 GHz.

8763 Series

8763A/B/C switches operate up to 26.5 GHz. They are preferred for drop-out or drop-in applications due to their compact design. These switches are used to automatically insert or remove a test component from a signal path. One port is internally terminated. Options T15 and T24 are available for TTL/5V CMOS compatibility.

8764 Series

8764A/B/C switches are available in three models up to 26.5 GHz. These switches are similar to the 8763, but with the internal termination replaced with a fifth port. Fifth port can be utilized for signal path reversal or as calibration port. Options T15 and T24 offer TTL/5V CMOS compatibility.

8765 Series

8765A/B/C/D/F are available in four models up to 40 GHz, as well as a 75 Ω model up to 4 GHz. These SPDT switches offer exceptional repeatability of 0.03 dB over 5 million cycles. Unlike the 8762 switches, they do not have internal switches, RF loads or DC current interrupts. Coil voltage options cover the complete range from 5 Vdc to 24 Vdc. Since the coils are not interrupted, the coil voltage may be continuous or may be switched off after 15 ms.

Specifications

Model	Frequency (GHz)	Termination	Average power (W)	Peak power (W)	Isolation (dB)	Insertion loss (dB)	SWR	Speed (ms)	Life cycle (million)	Driving voltage (Vdc)	RF connectors
8762A	DC to 4	Terminated	1	100	90	0.25	1.2	30	1	5, 15, 24	SMA (f)
8762B	DC to 18	Terminated	1	100	90	0.5	1.3	30	1	5, 15, 24	SMA (f)
8762C	DC to 26.5	Terminated	1	100	50	1.25	1.8	30	1	5, 15, 24	3.5 mm
8762F ¹	DC to 4	Terminated	1	100	90	0.4	1.3	30	1	24	mini SMB (m)
8765A	DC to 4	Unterminated	2	100	100	0.3	1.7	15	5	5, 10, 15, 24	SMA (f)
8765B	DC to 20	Unterminated	2	100	54	0.7	1.7	15	5	5, 15, 24	SMA (f)
8765C	DC to 26.5	Unterminated	2	100	50	0.2	1.7	15	5	5, 10, 15, 24	3.5 mm
8765D	DC to 40	Unterminated	2	100	50	1.12	1.5	15	5	5, 10, 15, 24	2.4 mm
8765F ¹	DC to 4	Unterminated	2	100	90	0.4	1.2	15	5	5, 10, 15, 24	mini SMB (m)

¹ 75 Ω impedance

Ordering Information

8762A/ 8762B/ 8762C

- Coil Voltage-024 24 Vdc
- Coil Voltage-T24 TTL/5V CMOS compatible logic with 24 Vdc supply
- Coil Voltage-011 5 Vdc
- Coil Voltage-015 15 Vdc

8762F

- Coil Voltage-T15 TTL/5V CMOS compatible logic with 15 Vdc supply
- Coil Voltage-024 24 Vdc
- Coil Voltage-011 5 Vdc
- Coil Voltage-015 15 Vdc

8765A/ 8765B/ 8765C/ 8765D/ 8765F

- Coil Voltage-005 5 Vdc with 3-inch ribbon cable
- Coil Voltage-305 5 Vdc with solder terminals
- Coil Voltage-010 10 Vdc with 3-inch ribbon cable
- Coil Voltage-310 10 Vdc with solder terminals
- Coil Voltage-015 15 Vdc with 3-inch ribbon cable
- Coil Voltage-315 15 Vdc with solder terminals
- Coil Voltage-024 24 Vdc with 3-inch ribbon cable
- Coil Voltage-324 24 Vdc with solder terminals
- RF Connector-241 2.4 mm (f) (for 8765D only)
- RF Connector-292 2.92 mm (f)
- DC Connector-108 8-inch ribbon cable extension
- DC Connector-116 16-inch ribbon cable extension

Web Link

www.agilent.com/find/switches

- **Guaranteed repeatability of 0.03 dB up to 5 million cycles**
- **Operating life of 10 million cycles typical**
- **Low SWR and Insertion loss**
- **High isolation > 90 dB at 12 GHz**



87104/6D



87406B



87222D

Transfer Switches – High Performance

The 87222C/D/E 4-port, coaxial transfer switches offer versatility in a number of applications from a drop out to signal reversal. They provide exceptional repeatability < 0.03 dB, a low insertion loss and high isolation. The 87222C operates from DC to 26.5 GHz, 87222D to 40 GHz and are warranted for 5 million cycles. The 87222E operates from DC to 50 GHz.

Matrix Switches – High Performance, Terminated

The 87506/606B 6-port, coaxial matrix switches will provide a valuable tool for 3 x 3, 2 x 4 and 1 x 5 configurations. These high performance matrix switches offer excellent repeatability and life greater than 5 million cycles. The 87406/606B operate from DC to 20 GHz with an excellent isolation, VSWR and with an input power of 1 W average/50 W peak (10 μs).

Multiport Switches – High Performance, Terminated

87104/106 and 87204/206 Series

87104A/B/C and 87106A/B/C multiport switches are available in 3 models up to 26.5 GHz. These switches offer exceptional repeatability of 0.03 dB over 5 million switching cycles. 87104 are a SP4T and 87106 is a SP6T function. Both switches have internal solid-state logic that automatically programs the non-used ports to a matched load when any one port is programmed “on”. This relieves the user from having to provide external logic drive pulses.

- 87104A
- 87104B
- 87104C
- 87104D
- 87106A
- 87106B
- 87106C
- 87106D
- 87204A
- 87204B
- 87204C
- 87206A
- 87206B
- 87206C
- 87222C
- 87222D
- 87222E
- 87406B
- 87606B

Specifications

Model	Frequency (GHz)	SWR (50 Ω nominal)	Insertion loss (dB)	Isolation (dB)	Switching time (max)	Repeatability	Life (min.)	RF connector	Dimensions W x H x D (mm)	Shipping weight (g)
87104A/204A SP4T	DC to 4	< 1.2 to 4 GHz	0.3 + 0.015 x f (GHz)	> 100 to 4 GHz	15 ms	0.03 dB	5 million	SMA (f)	57 x 74 x 57	229
87104B/204B SP4T	DC to 20	< 1.2 to 4 GHz < 1.35 to 12.4 GHz < 1.45 to 18 GHz < 1.7 to 20 GHz	0.3 + 0.015 x f (GHz)	> 100 to 12 GHz > 80 to 15 GHz > 70 to 20 GHz	15 ms	0.03 dB	5 million	SMA (f)	57 x 74 x 57	229
87104C/204C SP4T	DC to 26.5	< 1.7 to 20 – 26.5 GHz	0.3 + 0.015 x f (GHz)	> 65 to 20 – 26.5 GHz	15 ms	0.03 dB	5 million	SMA (f)	57 x 74 x 57	229
87106A/206A SP6T	DC to 4	< 1.2 to 4 GHz	0.3 + 0.015 x f (GHz)	> 100 to 4 GHz	15 ms	0.03 dB	5 million	SMA (f)	57 x 74 x 57	229
87106B/206B SP6T	DC to 20	< 1.2 to 4 GHz < 1.35 to 12.4 GHz < 1.45 to 18 GHz < 1.7 to 20 GHz	0.3 + 0.015 x f (GHz)	> 100 to 12 GHz > 80 to 15 GHz > 70 to 20 GHz	15 ms	0.03 dB	5 million	SMA (f)	57 x 74 x 57	229
87106C/206C SP6T	DC to 26.5	< 1.7 to 20 – 26.5 GHz	0.3 + 0.015 x f (GHz)	> 65 to 20 – 26.5 GHz	15 ms	0.03 dB	5 million	SMA (f)	57 x 74 x 57	229
87222C	DC to 26.5	< 1.1 to 2 GHz < 1.15 to 4 GHz < 1.25 to 12.4 GHz < 1.4 to 20 GHz < 1.65 to 26.5 GHz	0.2 + 0.025 x f (GHz)	120 – 2.0 x f (GHz) at DC to 26.5 GHz	15 ms	0.03 dB	5 million	SMA (f)	32 x 69 x 32	100
87222D	DC to 40	< 1.3 to 12.4 GHz < 1.4 to 25 GHz < 1.7 to 40 GHz	0.2 + 0.025 x f (GHz)	120 – 2.0 x f (GHz) at DC to 26.5 GHz > 60 at 26.5 to 40 GHz	15 ms	0.03 dB	5 million	2.92mm (f)	33 x 69 x 32	100
87222E	DC to 50	< 1.3 to 12.4 GHz < 1.4 to 20 GHz < 1.5 to 30 GHz < 1.6 to 40 GHz < 1.7 to 50 GHz	0.15 + 0.020 x f (GHz)	120 – 2.0 x f (GHz) at DC to 26.5 GHz > 60 at 26.5 to 50 GHz	15 ms	0.03 dB at DC to 26.5 GHz 0.05 dB at 26.5 to 50 GHz	5 million	2.4 mm (f)	34 x 69 x 32	100
87406B/606B	DC to 20	< 1.21 to 4 GHz < 1.35 to 10 GHz < 1.5 to 15 GHz < 1.7 to 18 GHz < 1.9 to 20 GHz	0.34 + 0.033 x f (GHz)	> 100 dB to 12 GHz > 80 dB to 15 GHz > 70 dB to 20 GHz	15 ms	0.03 dB	5 million	SMA (f)	57 x 74 x 57	229

Ordering Information

- 87104A/B/C**¹ SP4T, DC to 4/20/26.5 GHz
- 87106A/B/C**¹ SP6T, DC to 4/20/26.5 GHz
- 87204A/B/C** SP4T, DC to 4/20/26.5 GHz
- 87206A/B/C** SP6T, DC to 4/20/26.5 GHz
- 87222C/D/E** transfer, DC to 26.5/40/50 GHz

- 87406B** matrix, DC to 20 GHz
- 87406B-100** solder terminals
- 87406B-161** 16-pin DIP with ribbon cable
- 87406B-T24**² TTL/5V CMOS compatible logic (for 87406B only)
- 87406B-024** 24 Vdc without TTL logic
- 87406B-UK6** commercial calibration test data with certificate

¹ Provides sensing capability with 87130A
² Not available with 87204, 87206, or 87606 switches

Web Link

www.agilent.com/find/switches

L7104A
L7104B
L7104C
L7106A
L7106B
L7106C
L7204A
L7204B
L7204C
L7206A
L7206B
L7206C
L7222C

- **Guaranteed repeatability of 0.03 dB up to 2 million cycles**
- **Operating life of 5 million cycles typical**
- **Unmatched isolation, 90 dB minimum at 12 GHz**
- **Economically priced**



Agilent Economical High Performance Multiport and Transfer Switches

The Agilent L Series multiport/coaxial switches provide flexibility and simplification of design routing and conditioning applications. Operating from DC to 4/20/26.5 GHz, these switches provide exceptional 0.03 dB insertion loss repeatability warranted for 2 million cycles. The high isolation between ports of these switches, typically > 90 dB, reduces the influence of signals from other channels and system measurement uncertainties, making them ideal for use in large, multitiered switching systems. These switches are available in multiple configurations of single-pole-four-throw (SP4T), single-pole-six-throw (SP6T) and double-pole-double-throw (DPDT). It has the life and reliability required for automated test and measurement, signal monitoring and routing application at an economical price.

Specifications

Model	Frequency range (GHz)	SWR	Insertion loss (dB)	Isolation	Switching time (max)	Repeatability (max)	Life	Connector	Dimension W x H x D (mm)
L7104/L7204A L7106/L7206A	DC to 4	1.2 maximum	0.3 + 0.015 x frequency (GHz)	90 dB minimum	15 ms	0.03 dB	2 million (5 million typical)	SMA (f)	57.15 x 71.53 x 57.15
L7104/L7204B L7106/L7206B	DC to 20	DC to 4 GHz: 1.2 maximum 4 to 12.4 GHz: 1.35 maximum 12.4 to 20 GHz: 1.7 maximum	0.3 + 0.015 x frequency (GHz)	DC to 12 GHz: 90 dB minimum 12 to 15 GHz: 70 dB minimum 15 to 20 GHz: 65 dB minimum	15 ms	0.03 dB	2 million (5 million typical)	SMA (f)	57.15 x 71.53 x 57.15
L7104/L7204C L7106/L7206C	DC to 26.5	DC to 4 GHz: 1.2 maximum 4 to 12.4 GHz: 1.35 maximum 12.4 to 18 GHz: 1.45 maximum 18 to 26.5 GHz: 1.7 maximum	0.3 + 0.015 x frequency (GHz)	DC to 12 GHz: 90 dB minimum 12 to 15 GHz: 70 dB minimum 15 to 20 GHz: 65 dB minimum 20 to 26.5 GHz: 60 dB minimum	15 ms	0.03 dB	2 million (5 million typical)	SMA (f)	57.15 x 71.53 x 57.15
L7222C	DC to 26.5	1.65 maximum at 26.5 GHz	0.2 + 0.025 x frequency (GHz)	110 dB – 2.0 x frequency (GHz)	15 ms	0.03 dB	2 million (5 million typical)	SMA (f)	31.75 x 56.80 x 23.11

Ordering Information

L7104A DC to 4 GHz, SP4T, terminated
L7104B DC to 20 GHz, SP4T, terminated
L7104C DC to 26.5 GHz, SP4T, terminated
L7106A DC to 4 GHz, SP6T, terminated
L7106B DC to 20 GHz, SP6T, terminated
L7106C DC to 26.5 GHz, SP6T, terminated
L7204A DC to 4 GHz, SP4T, unterminated
L7204B DC to 20 GHz, SP4T, unterminated
L7204C DC to 26.5 GHz, SP4T, unterminated
L7206A DC to 4 GHz, SP6T, unterminated
L7206B DC to 20 GHz, SP6T, unterminated
L7206C DC to 26.5 GHz, SP6T, unterminated
L7XXX-100 solder terminals to replace ribbon cable
L7XXX-UK6 commercial calibration test data with certificate
L7XXX-T24 TTL/5V V CMOS compatible option
L7222C DC to 26.5 GHz transfer switch
11713B/C attenuator switch driver, drive up to 10 sections of switches or attenuators

Web Link

www.agilent.com/find/switches

- Superior performance with high isolation
- Fast switching speed across broad operating frequency range
- Safe, accurate test for sensitive RFIC component

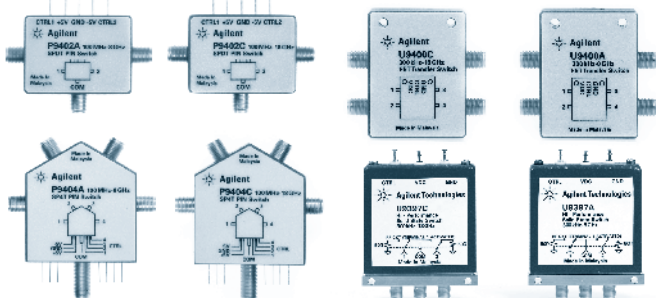

PIN solid state switches

FET solid state switches

85331/2B PIN Solid State Switches

The Agilent 85331B (SPDT) and 85332B (SP4T) are absorptive PIN diode solid state switches which provide a superior performance in terms of isolation and fast switching speed across a broad frequency range of 45 MHz to 50 GHz. These absorptive switches are designed for high frequency usage and are extremely useful for applications in instrumentation, communications, radar and many other test systems that require high-speed RF and microwave switching.

P9400A/C PIN Solid State Transfer Switches

The Agilent P9400A/C solid state PIN diode switches offers outstanding performance of port-to-port isolation, switching speed, and low insertion loss over a broad operating frequency range of 100 MHz to 8/18 GHz.

Specifications

Model	Frequency (GHz)	Termination	Isolation (dB)	Insertion loss (dB)	Return loss for ON port (dB)	Switching speed rise/fall	Typical video leakage (mVpp)	Connector	Input power (average)	Driving voltage
PIN SPDT										
P9402A	100 MHz to 8 GHz	Absorptive	80	3.2	15	380 ns	3400	SMA (f)	23 dB	5
P9402C	100 MHz to 18 GHz	Absorptive	80	4	10	380 ns	3400	SMA (f)	23 dB	5
85331B	45 MHz to 50 GHz	Absorptive	75	15.5 at 26.5 GHz	4.5	1 μs	7000	2.4 mm (f)	27 dB	7
PIN SP4T										
P9404A	100 MHz to 8 GHz	Absorptive	80	3.5	15	350 ns	2800	SMA (f)	27 dB	5
P9404C	100 MHz to 18 GHz	Absorptive	80	4.5	10	350 ns	2800	SMA (f)	27 dB	5
85332B	45 MHz to 50 GHz	Absorptive	75	15.5 at 26.5 GHz	4.5	1 μs	7000	2.4 mm (f)	27 dB	7
PIN transfer										
P9400A	100 MHz to 8 GHz	NA	80	3.5	15	200 ns	600	SMA (f)	23 dB	5
P9400C	100 MHz to 18 GHz	NA	80	4.2	10	200 ns	600	SMA (f)	23 dB	5
FET SPDT										
U9397A	300 kHz to 8 GHz	Absorptive	100	3.5	15	5/0.5 μs	10	SMA (f)	29 dB	12 to 24 V
U9397C	300 kHz to 18 GHz	Absorptive	90	6.5	10	5/0.5 μs	10	SMA (f)	27 dB	12 to 24 V
FET transfer										
U9400A	300 kHz to 8 GHz	NA	100	3.5	15	4/0.5 μs	5	SMA (f)	29 dB	11 to 26 V
U9400C	300 kHz to 18 GHz	NA	90	6.5	10	5/1 μs	5	SMA (f)	27 dB	11 to 26 V

Ordering Information

P9400A solid state PIN diode switch, 100 MHz to 8 GHz
P9400C solid state PIN diode switch, 100 MHz to 18 GHz
P9402A PIN solid state switch, 100 MHz to 8 GHz, SPDT
P9402C PIN solid state switch, 100 MHz to 18 GHz, SPDT
P9404A PIN solid state switch, 100 MHz to 8 GHz, SP4T
P9404C PIN solid state switch, 100 MHz to 18 GHz, SP4T
U9397A FET solid state switch, 300 kHz to 8 GHz, SPDT
U9397C FET solid state switch, 300 kHz to 18 GHz, SPDT
U9400A solid state FET transfer switch, 300 kHz to 8 GHz
U9400C solid state FET transfer switch, 300 kHz to 18 GHz
85331B PIN solid state switch, 45 MHz to 50 GHz, SPDT
85332B PIN solid state switch, 45 MHz to 50 GHz, SP4T

The P9400A/C are well-suited for ultra-fast RF and microwave switching applications in instrumentation, radar, switch matrices, and various other systems where high isolation, speed and lifetime of a switch are critical.

P9402A/C (SPDT) and P9404A/C (SP4T) PIN Solid State Switches

The Agilent P9402A/C and P9404A/C PIN solid state switches maximize your operating frequency range from 100 MHz to 8/18 GHz. Providing superior performance in terms of isolation, insertion loss and return loss. The switches are suitable for high-speed RF and microwave switching applications such as switch matrices in instrumentation, communications and radar. These switches provide ultra-fast switching speed to increase throughput in manufacturing.

U9397A/C FET Solid State Switches

Agilent U9397A and U9397C FET solid state switches (SPDT) provide superior performance offering low video leakage, high isolation, fast settling time and low insertion loss across a broad operating frequency. The U9397A/C are particularly suitable for measuring sensitive components, such as mixers and amplifier, where video leakage may cause damage or reliability issues.

U9400A/C FET Solid State Transfer Switches

Agilent U9400A/C solid state FET transfer switches offer outstanding performance in isolation, switching speed and video leakage over a frequency range from 300 kHz to 8 GHz. The low video leakage of these switches makes them particularly suitable for testing sensitive RFIC components. Use P9400A/C in RF and microwave switching applications requiring high isolation, fast switching speed, and low video leakage over a long switching life cycles.

- 85331B
- 85332B
- P9400A
- P9400C
- P9402A
- P9402C
- P9404A
- P9404C
- U9397A
- U9397C
- U9400A
- U9400C

Web Link

www.agilent.com/find/solidstateswitch

J7211A
J7211B
J7211C

- **Guaranteed 0.03 dB insertion loss repeatability**
- **Excellent attenuation accuracy and flatness**
- **Display of exact corrected attenuation value**
- **Application-specific attenuation sweep function**
- **Easy remote integration with GPIB, USB and LAN connectivity**
- **Relative attenuation step function for relative measurements**



J7211B attenuation control unit, DC to 18 GHz

An Integrated Attenuation Solution for Wireless Communications

J7211A/B/C attenuation control units provide an integrated solution for R&D and manufacturing engineers in wireless communications, aerospace and defense, and electronic component industries. Operating from DC to 26.5 GHz, the J7211A/B/C provides attenuation up to 121 dB with a 1 dB step size. A unique attenuation sweep function lets you select the start/stop attenuation, step size, dwell time and number of cycles for your application. J7211A/B/C offers exceptional < 0.03 dB insertion loss repeatability per section for the entire 5 million cycles which reduces your cost of ownership.

Designed in a compact half-rack, 2 unit high-form factor, the Agilent J7211A/B/C ensures ease-of-use in benchtop applications and greater efficiency and throughput in ATE testing. GPIB, USB and LAN connectivity (LXI Class C compliant) allow easy remote control and triggering.

Typical Applications

J7211A/B/C attenuation control unit's attenuation sweep function makes it ideal for designing, validating and manufacturing WiMAX and WLAN components and for mobile handset base transceiver station (BTS) handover test where you can set your own application-specific measurement parameters.

Product Specifications

Model	J7211A	J7211B	J7211C
Frequency range	DC to 6 GHz	DC to 18 GHz	DC to 26.5 GHz
Attenuation range	0 to 121 dB	0 to 121 dB	0 to 101 dB
Attenuation step size	1, 5 and 10 dB	1, 5 and 10 dB	1, 5 and 10 dB
Insertion loss (at 0 dB)	DC to 6 GHz: 2.5 dB	DC to 6 GHz: 2.5 dB 6 to 18 GHz: 5.0 dB	DC to 6 GHz: 2.5 dB 6 to 18 GHz: 4.0 dB 18 to 26.5 GHz: 5.0 dB
Return loss (VSWR)	DC to 6 GHz: 14 dB (1.50)	DC to 6 GHz: 14 dB (1.50) 6 to 18 GHz: 10 dB (1.90)	DC to 6 GHz: 16 dB (1.35) 6 to 18 GHz: 11 dB (1.78) 18 to 26.5 GHz: 7 dB (2.61)
RF repeatability	0.03 dB	0.03 dB	0.05 dB
Maximum power input	1 W (+ 30 dBm)	1 W (+ 30 dBm)	1 W (+ 30 dBm)
Switching speed	20 ms	20 ms	20 ms
Operating life	5 million cycles (guaranteed)	5 million cycles (guaranteed)	5 million cycles (guaranteed)
Connectivity	GPIB, USB, LAN (LXI Class C)	GPIB, USB, LAN (LXI Class C)	GPIB, USB, LAN (LXI Class C)
Connector type	SMA/type-N	SMA/type-N	3.5 mm

Additional Functions

Attenuation sweep function

Provides user-defined parameter setting for application-specific testing.

Key parameter settings:

- Delay time before START
- Attenuation range
- Attenuation step size (1 to 10 dB; 1 dB incremental)
- Attenuation start, stop and dwell time (100 ms to 10 s; 100 ms incremental)
- Number of attenuation cycles (1000 cycles maximum)
- Forward and backward attenuation cycles

Relative attenuation step function

Enables testing relative to any preset attenuation values.

Display of data correction value

Display correction value for attenuation using stored calibration data.

Ordering Information

J7211A attenuation control unit, DC to 6 GHz, 0 to 121 dB

J7211A-001 type-N (f) connector

J7211A-002 SMA (f) connector

J7211A-UK6 commercial calibration certificate with test data

J7211B attenuation control unit, DC to 18 GHz, 0 to 121 dB

J7211B-001 type-N (f) connector

J7211B-002 SMA (f) connector

J7211B-UK6 commercial calibration certificate with test data

Web Link

www.agilent.com/find/J7211

- High reliability and exceptional repeatability reduce downtime
- Excellent RF specifications optimize test system measurement capability
- Broad portfolio of attenuation and connector options provide configuration flexibility

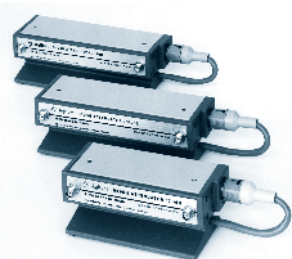

Programmable step attenuators

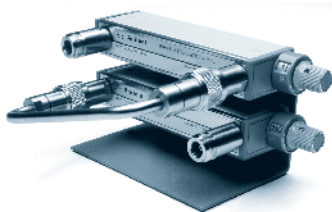

11716A/C attenuator interconnect kits

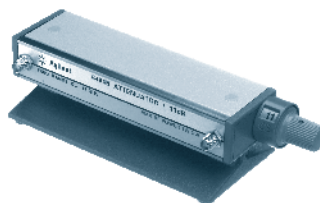

Manual step attenuators

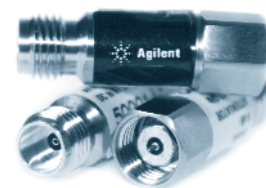

Fixed attenuator

Agilent coaxial fixed and step attenuators are designed for use in a wide variety of signal conditioning and level control applications. Attenuators are generally used to reduce signal levels, improve matching impedances of the sources and loads, and measure the gain loss of two-port devices.

Programmable and Manual Step Attenuators

Agilent programmable step attenuators offer fast, precise signal-level control up to 50 GHz, with switching time of less than 20 ms. Unmatched attenuation repeatability of less than 0.03 dB up to 5 million cycles per section ensures low measurement uncertainty and reduces calibration cycles when installed into test systems. Automatic GPIB/USB/LAN drive control is achieved with the 11713B/C attenuator switch driver. Attenuation range of 121 dB in 1 dB step can be achieved by cascading 2 attenuators in series.

Fixed Attenuator

Agilent coaxial fixed attenuators provide precise attenuation, flat frequency response, and low SWR over a broad frequency range from DC up to 67 GHz. These attenuators are available in nominal attenuations of 3, 6, 10, 20, 30, 40 and 60 dB to cater to various applications and setups.

Attenuator Sets

A set of four Agilent attenuators – 3, 6 10 and 20 dB are furnished in a walnut accessory case. These sets are ideal for calibration labs or where precise knowledge of attenuation and SWR is desired.

11716A/C Attenuator Interconnect Kits

Quickly and conveniently connect 1 dB step and 10 dB step attenuators together to achieve greater dynamic range with 1 dB steps. The 11716A/C interconnect kits contain a rigid RF cable, mounting bracket, and necessary hardware to connect any pair of 8494/95/96/97 attenuators in a series. Attenuators must be ordered separately.

Specifications

Coaxial fixed attenuator

Model	Frequency	Attenuation accuracy								Maximum SWR	Maximum input average power (W)	Maximum input peak power (W)	RF connectors
		3 dB	6 dB	10 dB	20 dB	30 dB	40 dB	50 dB	60 dB				
8491A	DC to 12.4 GHz	0.3	0.3	0.5	0.5	1.0	1.5	1.5	2.0	1.30	2	100	N (m, f)
8493A	DC to 12.4 GHz	0.3	0.3	0.5	0.5	1.0	—	—	—	1.30	2	100	SMA (m, f)
8491B	DC to 18 GHz	0.3	0.4	0.6	1.0	1.0	1.5	1.5	2.0	1.50	2	100	N (m, f)
8493B	DC to 18 GHz	0.3	0.4	0.6	1.0	1.0	—	—	—	1.50	2	100	SMA (m/f)
8498A	DC to 18 GHz	—	—	—	—	1.0	—	—	—	1.30	25	125	N (m, f)
8493C	DC to 26.5 GHz	1.0	0.6	0.5	0.6	1.0	1.3	—	—	1.25	2	100	3.5 mm (m, f)
8490D	DC to 50 GHz	4.8	7.8	11.3	21.7	31.7	42.5	—	—	1.45	1	100	2.4 mm (m, f)
8490G	DC to 67 GHz	4.8	7.8	11.3	21.5	31.7	42.5	—	—	1.45	1	100	1.85 mm

Manual step attenuator

Model	Frequency	Attenuation range (dB)	Attenuation step (dB)	Insertion loss (dB) @ 0 dB	Maximum SWR	Maximum input average power (W)	Maximum input peak power (W)	Operating life (n million cycles/section)	Repeatability (dB)
8494A	DC to 4 GHz	0 to 11	1	0.96	1.50	1	100	5	±0.03
8495A	DC to 4 GHz	0 to 70	10	0.68	1.35	1	100	5	±0.03
8496A	DC to 4 GHz	0 to 110	10	0.96	1.50	1	100	5	±0.03
8494B	DC to 18 GHz	0 to 11	1	2.22	1.90	1	100	5	±0.03
8495B	DC to 18 GHz	0 to 70	10	1.66	1.70	1	100	5	±0.03
8496B	DC to 18 GHz	0 to 110	10	2.22	1.90	1	100	5	±0.03
8495D	DC to 26.5 GHz	0 to 70	10	3.95	2.20	1	100	5	±0.03

* All product models listed above offer RF connector options for N (f) / SMA (f) / APC-7[®] except 8495D which only offer 3.5 mm (f) RF connectors

- 8494A
- 8494B
- 8494G
- 8494H
- 8495A
- 8495B
- 8495D
- 8495G
- 8495H
- 8495K
- 8496A
- 8496B
- 8496G
- 8496H
- 8497K
- 84904K
- 84904L
- 84904M
- 84905M
- 84906K
- 84906L
- 84907K
- 84907L
- 84908M

8494A
8494B
8494G
8494H
8495A
8495B
8495D
8495G
8495H
8495K
8496A
8496B
8496G
8496H
8497K
84904K
84904L
84904M
84905M
84906K
84906L
84907K
84907L
84908M

Programmable step attenuator

Model number	Frequency	Attenuation range (dB)	Attenuation step (dB)	Insertion loss (dB) @ 0 dB	Maximum SWR	Maximum input average power (W)	Maximum input peak power (W)	Operating life (n million cycles/section)	Repeatability (dB)
8494G	DC to 4 GHz	0 to 11	1	0.96	1.50	1	100	5	±0.03
8495G	DC to 4 GHz	0 to 70	10	0.68	1.35	1	100	5	±0.03
8496G	DC to 4 GHz	0 to 110	10	0.96	1.50	1	100	5	±0.03
8494H	DC to 18 GHz	0 to 11	1	2.22	1.90	1	100	5	±0.03
8495H	DC to 18 GHz	0 to 70	10	1.66	1.70	1	100	5	±0.03
8496H	DC to 18 GHz	0 to 110	10	2.22	1.90	1	100	5	±0.03
8495K	DC to 26.5 GHz	0 to 70	10	3.95	2.20	1	100	5	±0.03
8497K	DC to 26.5 GHz	0 to 90	10	2.79	1.80	1	100	5	±0.03
84904K	DC to 26.5 GHz	0 to 11	1	1.86	2.00	1	50	5	±0.03
84906K	DC to 26.5 GHz	0 to 90	10	1.86	2.00	1	50	5	±0.03
84907K	DC to 26.5 GHz	0 to 70	10	1.40	1.90	1	50	5	±0.03
84904L	DC to 40 GHz	0 to 11	1	2.40	2.00	1	50	5	±0.03
84906L	DC to 40 GHz	0 to 90	10	2.40	2.00	1	50	5	±0.03
84907L	DC to 40 GHz	0 to 70	10	1.80	1.90	1	50	5	±0.03
84904M	DC to 50 GHz	0 to 11	1	3.00	3.00	1	50	5	±0.03
84905M	DC to 50 GHz	0 to 60	10	2.60	2.60	1	50	5	±0.03
84908M	DC to 50 GHz	0 to 65	5	3.00	3.00	1	50	5	±0.03

RF Connector Options:

- 1) 849xG/H offers N (f)/SMA (f)/APC-7
- 2) 849xK offers only 3.5 mm (f)
- 3) 8490xK offers 3.5 mm (f)/3.5 mm (f/m)
- 4) 8490xL offers 2.4 mm (f), 2.92 mm (f)/2.4 mm (f/m) / 2.92 mm (f/m)
- 5) 8490xM offers 2.4 mm (f/m)/2.4 mm (f/f)

Ordering Information

Programmable and manual step attenuators

- 8494G** 0 to 11 dB, 1 dB steps, DC to 4 GHz
- 8494H** 0 to 11 dB, 1 dB steps, DC to 18 GHz
- 8495G** 0 to 70 dB, 10 dB steps, DC to 4 GHz
- 8495H** 0 to 70 dB, 10 dB steps, DC to 18 GHz
- 8495K** 0 to 70 dB, 1 dB steps, DC to 26.5 GHz
- 8496G** 0 to 110 dB, 10 dB steps, DC to 4 GHz
- 8496H** 0 to 110 dB, 10 dB steps, DC to 18 GHz
- 8497K** 0 to 90 dB, 10 dB steps, DC to 26.5 GHz
- 84904K** 0 to 11 dB, 1 dB steps, DC to 26.5 GHz
- 84904L** 0 to 11 dB, 1 dB steps, DC to 40 GHz
- 84904M** 0 to 11 dB, 1 dB steps, DC to 50 GHz
- 84905M** 0 to 60 dB, 10 dB steps, DC to 50 GHz
- 84908M** 0 to 65 dB, 5 dB steps, DC to 50 GHz
- 84906K** 0 to 90 dB, 10 dB steps, DC 26.5 GHz
- 84906L** 0 to 90 dB, 10 dB steps, DC to 40 GHz
- 84907K** 0 to 70 dB, 10 dB steps, DC to 26.5 GHz
- 84907L** 0 to 70 dB, 10 dB steps, DC to 40 GHz
- 8494A** 0 to 11 dB, 1 dB steps, DC to 4 GHz
- 8494B** 0 to 11 dB, 1 dB steps, DC to 18 GHz
- 8495A** 0 to 70 dB, 10 dB steps, DC to 4 GHz
- 8495B** 0 to 70 dB, 10 dB steps, DC to 18 GHz
- 8495D** 0 to 70 dB, 1 dB steps, DC to 26.5 GHz
- 8496A** 0 to 110 dB, 10 dB steps, DC to 4 GHz
- 8496B** 0 to 110 dB, 10 dB steps, DC to 18 GHz
- 001** type-N female connectors (8494/5/6/7 only)
- 002** SMA female connectors (8494/5/6/7 only)
- 003** APC-7 connectors (8494/5/6/7 only)
- 004** 3.5 mm connectors (8495D/K, 8497K, 8490xK only)
- 006** 2.92 mm female connectors (8490xL only)
- 011** 5 Vdc supply voltage
- 015** 15 Vdc supply voltage
- 024** 24 Vdc supply voltage
- 100** 2.4 mm female and 2.4 mm male (8490xL only)
- 101** 2.4 mm female connectors (8490xL only)
- 104** 3.5 mm male connectors (8490xK only)
- 106** 2.92 mm male connectors (8490xL only)
- UK6** commercial calibration test data with certificate

Fixed attenuator

- 8490D, 8490G, 8491A, 8491B, 8493A, 8493B, 8493C, 8498A**
- 003** 3 dB attenuation
- 006** 6 dB attenuation
- 010** 10 dB attenuation
- 020** 20 dB attenuation
- 030** 30 dB attenuation
- 040** 40 dB attenuation
- 050** 50 dB attenuation
- 060** 60 dB attenuation
- UK6** commercial calibration test data with certificate
- 11581A** 3, 6, 10, 20 dB 8491A set
- 11582A** 3, 6, 10, 20 dB 8491B set
- 11583C** 3, 6, 10, 20 dB 8493C set
- 86213A** 3, 6, 10, 20 dB 75 ohm set

Web Link

www.agilent.com/find/attenuators

- Switching system offers flexible switch mounting options that are robust and reliable
- 3D models included for quick RF cable layout and documentation
- Graphical Web interface for quick setup, troubleshooting and support
- Easy connection and control of all the most popular microwave switches and attenuators
- Effective switch management with switch verification, sequences and relay counter
- Software drivers for most common programming environments
- GPIB and Ethernet connectivity. LXI Class C compliant



L4490A (2U) and L4491A (4U) RF/microwave switch platforms

The Agilent L4490A (2U rack size) and the L4491A (4U rack size) RF switch platforms provide the switch drive control and space to mount all the most popular switches and attenuators. They come standard with 64 coil drives integrated into the enclosures. The L4491A Option 002 allows an additional 64 coil drives. Both platforms feature a bottom plate with pre-drilled holes for mounting switches, attenuators and other signal conditioning components.

The distribution boards provide the right power and control signals using standard ribbon cables enabling simple connections to the switches. Switch sequences, verification, and relay counts included within the graphical Web interface ensure quick set-up and help reduce the time for troubleshooting and repair. The L4490A and L4491A offer full support and compatibility for standard programming environments.

This platform is ideal for R&D and manufacturing engineers creating custom switch matrices for aerospace defense and wireless applications testing mobile radios, handsets, base stations, radio components, and other wireless devices. Also, with the broad range of supported switches up to 50 GHz, you can future-proof your investment for emerging standards like WiMAX, LTE and UWB. Build custom designs from multiplexers, blocking or non-blocking matrices or a combination of both with signal conditioning to meet your unique needs.

The RF switch platforms easily integrates into your test environment with standard rack mount kits, LAN and GPIB connectivity, graphical Web interface and software drivers for the most common programming environments.

Specifications

- L4490A and L4491A come standard with 64 switch coil drive lines (enough to control 32 standard SPDT switches or 8 multiport switches with appropriate distribution boards)
- Option 002 expands to control another 64 coils and offers access to 5 V, 12 V and 24 V supplies to power other devices in an RF switch matrix
- Option 004 adds 16 digital IO lines and 28 more relay drive lines

Supported switches and attenuators

The following Agilent microwave switches and attenuators are directly supported with the Y1150A-Y1155A distribution boards:

- N181x/U9397x Series SPDT switches, see page 325 and 329
- 8762/3/4 Series SPDT switches, see page 326
- 8765x coaxial switches, see page 326
- 8766x/8767x/8768x multiport switches
- 87104x/106x/L710xx/L720xx multiport switches, see page 327 and 328
- 87406x Series matrix switches, see page 327
- 87204x/206x Series multiport switches, see page 327
- 87606x Series matrix switches, see page 327
- 87222x/L7222 transfer switches, see page 327 and 328
- 849x/8490x Series attenuators, see page 331
- Other switches and devices through individual screw terminal connections

Abridged product specifications

Switch drive	64 channels, low side drive mode	Driver off voltage (max)	30 V
		Driver off leakage current	500 μ A
		Driver on current (max)	600 mA
		Driver on voltage (max)	0.5 V at 600 mA
	64 channels, TTL drive mode	Hi output voltage	3 V at Iout = 2 mA
		Lo output voltage	0.4 V at Iin = 20 mA
		Lo input current	20 mA
Position indicator sense inputs	Channels	64	
	Lo input voltage (max)	0.8 V	
	Hi input voltage (min)	2.5 V	
	Input resistance	> 100 k Ω at Vin \leq 5 V > 20 k Ω at Vin > 5 V	
	Maximum input voltage	30 V	
Switch drive power supply	Voltage	24 V nominal	
	Current	600 mA	
External power connection	Voltage range	4.75 to 30 V	
	Current limit	2 A	
LED indicator (current mode drivers)	Channels	64	
	Supply voltage	5 V nominal	
	LED drive current	5 mA nominal (prog 1-20 mA)	
	Driver compliance voltage	0.8 V	
Memory	States 5 instrument states with user label in non-volatile memory		

Ordering Information

Configuration and pricing depends on customer's defined configuration. See the Agilent L4490A/91A RF switch platform data sheet 5989-7857EN to learn more.

L4490A 2U RF switch platform

L4491A 4U RF switch platform

- 001 front panel with holes to mount up to 8 Agilent 87xxx or L7xxx style multiport switches
- 002 add 64 additional switch drive lines with additional 34945EXT
- 004 add 16 bit digital IO and 28 bits of relay drive lines

Web Link

www.agilent.com/find/L4490A

www.agilent.com/find/L4491A

L4490A

L4491A





8

Used Agilent Test Equipment, Support & Services

Used Test Equipment and Finance Solutions	336
Repair and Calibration Services	337
Application Engineering Services	339

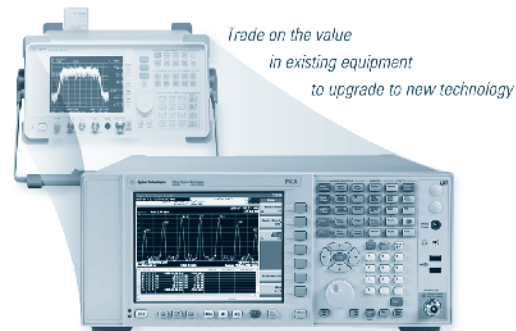

Buy Remanufactured Equipment Agilent Premium Used Equipment

Expand your budget.

You face economic uncertainty and a shrinking budget, but you still need a variety of test equipment for R&D and manufacturing. Make the most of your limited funds with Agilent Premium Used Equipment. Pay up to 50% less for instruments that meet new product standards and come with the same warranty – plus the option to extend coverage at the new product price.

- Savings: 20 to 50% (and occasionally more) off list price
- Quality: like-new performance
- Accuracy: fully calibrated with actual test data supplied
- Capabilities: upgraded firmware and software
- Convenience: same standard accessories and manuals as new
- Confidence: same warranty and return policy as new

Buy New Technology for Less Agilent Premium Trade-In Solutions

Discover additional funds you didn't know you had.

You need to refresh your technology – but at the same time, you must limit expenditures. Your current equipment holds the key to affording the tools you need. Trade on the residual value for next-generation technology that meets higher standards and makes asset management easier and more cost-effective.

- Savings: up to 50% off list price for a new product introduction or up to 100% of the total new equipment cost with a custom deal

- Flexibility: thousands of used T&M models from Agilent and other vendors accepted for trade
- Scope: credit available for hundreds of new models, plus services and Agilent Premium Used Equipment
- Timing: Agilent knowledge of product life cycles optimizes the value you receive
- Options: custom deals that let you decide what you want to buy, finance and rent

Sell Underutilized Assets

Agilent Buy-Back

Sell your equipment for cash.

Get cash for your underutilized equipment and use it to buy technology that maintains your leadership position. We'll help you dispose of all your unwanted instruments – not just a few select items – and make your bottom line look better.

- Value: competitive pricing from a company you know and trust
- Knowledge: a global network of sales engineers and used equipment dealers who understand and support local market needs
- Simplicity: lower costs for asset tracking, maintenance, insurance and taxes

Lease or Rent Equipment

Lease and Finance

Get options tailored for you.

Agilent offers a cost-effective, flexible range of lease and finance options. Whether you're looking for a competitive edge, a hedge against obsolescence, or an improved cash flow, we offer solutions designed just for you.

- Affordability: little or no upfront cost and payments spread over time

- Consistency: same amount budgeted every month for the contract term
- Budget: payments that fit your requirements and include maintenance, repair and calibration
- Flexibility: untouched working capital and lines of credit that enable you to make other investments
- Support: expert advice from specialists in financing for high-tech industries

Rent or Rent to Buy

Enjoy competitive rates, fast delivery and excellent service.

Rent – if you need equipment for less than 12 months, rent from one of our premier rental partners. Their expert inventory management and priority access to new Agilent products mean you get the right tool at the right time. At the end of the term, you can renew month-to-month or return the equipment to us.

Rent to buy – if you need equipment for a minimum of 6 months while you make an investment decision, you can rent with the option to buy and receive credits of up to 50% of payments made when the term ends.

- Speed: prompt delivery for immediate needs
- Response: fast fulfillment of short-term equipment requirements
- Budget: less impact when meeting equipment demands
- Flexibility: protection against short product life cycles, rapidly changing technology and delayed capital budgets

Web Link

- www.agilent.com/find/used
- www.agilent.com/find/trade
- www.agilent.com/find/buyback
- www.agilent.com/go/wwwleasing
- www.agilent.com/find/rent

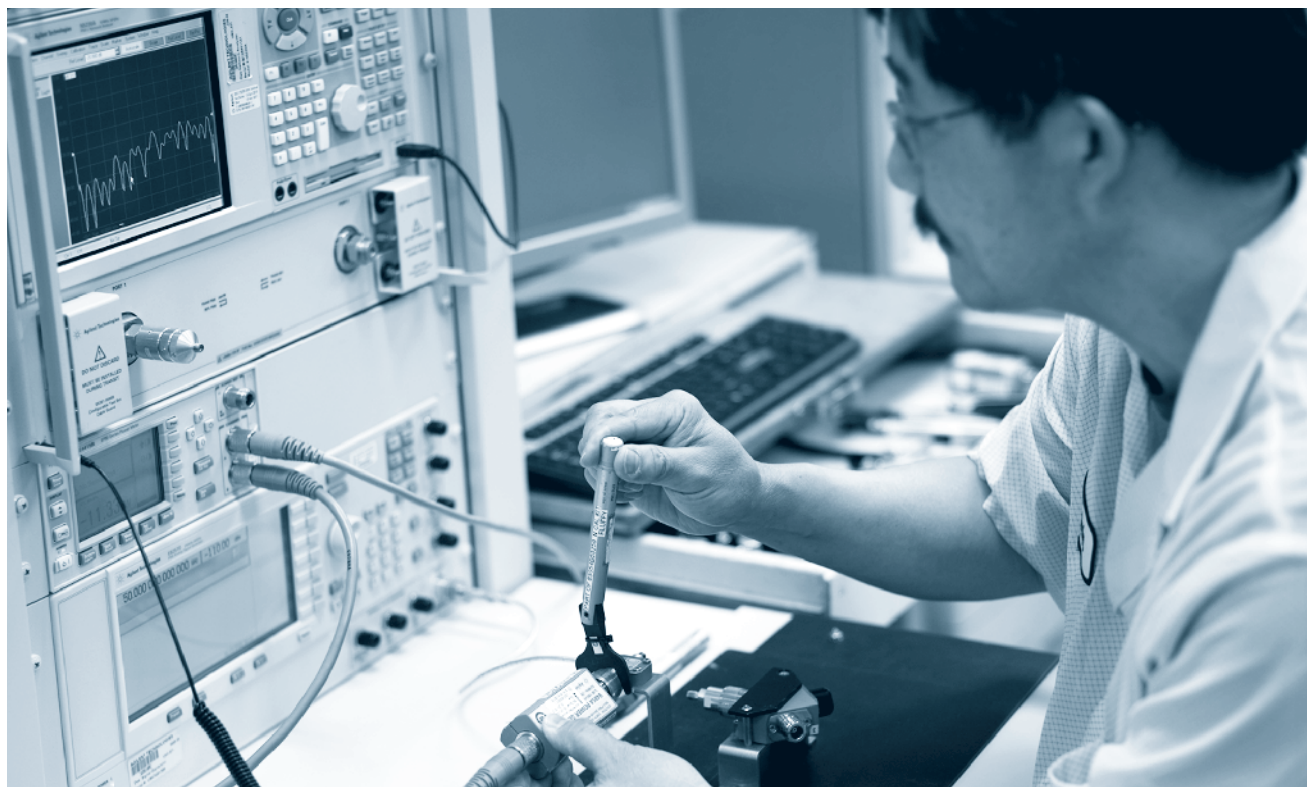

Agilent Advantage Services is committed to your success throughout your equipment’s lifetime. We share measurement and service expertise to help you create the products that change our world. To keep you competitive, we continually invest in tools and processes that speed up calibration and repair, reduce your cost of ownership, and keep us abreast of your development needs.

Agilent Advantage Services include repair, calibration, volume onsite calibration services, and Infoline web services. We offer a variety of purchasing options, including upfront at the time of instrument purchase for extended warranty and calibration – saving you time and money. Following is a brief description of Agilent Advantage Services.

Agilent Repair Services – Restore your Equipment to the Highest Level of Precision and Accuracy

Agilent knows that most repairs are unexpected and can cause unplanned down-time. If an equipment failure occurs, you need to get back up and running as quickly as possible. Agilent has the depth of expertise required to diagnose your equipment problems quickly and restore your equipment to full functionality and performance.

Features:

- Expert service technicians use Agilent diagnostic tools and genuine replacement parts
- Automated systems and procedures verify product repairs
- Worldwide service centers have access to factory engineers, service notes and firmware upgrades

Benefits:

- Reduced cost and risk – factory tools, knowledge and parts mean getting it done right the first time
- Faster turnaround time – warranty extensions and repair agreements minimize unplanned delays and expenses
- More confidence – your instrument is restored to like new condition and returned on time

Service solutions	Description
Upfront warranty extension	Multi-year warranty extensions can be ordered with significant savings at the time of the instrument purchase
Repair agreement	Warranty-like coverage at a low monthly cost. Agreements include priority service for faster turnaround time
Repair per incident	Service can be purchased when needed, but a quote, purchase order and invoice are required for each transaction
On-site repair	For shortest downtime, Agilent personnel will travel to your site to support high-uptime or high-security systems

Agilent Calibration Services – Ensure your Equipment Makes Measurements you can Count On

Testing, measuring, and monitoring are all about managing risk and ensuring success with your product, process or network. We test every specification with a performance test and adjust whenever a parameter is out-of-spec. You will get a full report as physical evidence of every action performed. Agilent’s worldwide customer services network is designed to improve your equipment uptime and lower your cost of ownership while ensuring your equipment makes measurements you have confidence in.

Features:

- Automated verification procedures test all product specifications and include all adjustments
- Calibrations can be performed at your site or at over 30 accredited service centers around the world
- Agilent metrologists work with standards committees and accreditation bodies to develop fully-accredited calibrations

Benefits:

- Measurement confidence – comprehensive testing verifies your equipment meets all of its specifications
- Save time – local calibration centers provide quick turnaround time to minimize your production downtime
- Save money – Agilent calibration and adjustments helps you reduce the need for repairs

Service solutions	Description
Upfront calibration plan	Multi-year calibration plans can be ordered with significant savings at the time of the equipment purchase
Calibration agreement	Calibrations are provided per recommended intervals. Agreements include priority service for faster turnaround time
Calibration per incident	Service can be purchased when needed, but a quote, purchase order and invoice are required for each transaction
Volume on-site calibration	For shortest downtime, Agilent personnel will setup automated test systems and perform calibrations at your site

Volume On-Site Calibration (VOSCAL) Services – Bring Agilent’s High Quality Calibration Standards and Services to your Site

Our comprehensive on-site solution offers a fully operational, high quality calibration laboratory on your site, complete with high-specification systems and automation. Our VOSCAL teams work with your team to plan the calibration event, ensure the correct calibration standards are available, your equipment is ready, and calibration is performed.

Features:

- Fully operational, high quality calibration laboratory at your site
- Calibration performed by a team of specialist engineers using industry standard tools and processes
- Project management throughout the operation

Benefits:

- Reduce equipment downtime, maximize uptime
- Convenience of a single supplier managing the calibration of all of your equipment
- Reduce costs by eliminating transport, extra transactions, and short-term rentals

Agilent Infoline Web Services – Puts you in Control

We understand you want to access service and support information quickly, at any time the need arises. Agilent’s Infoline web services provides registered customers with a secure web solution to manage their test equipment, purchases and service events (based on data loaded automatically by Agilent).

Features:

- Service requests – Request services online to your local Agilent Service Center
- Service prices – Price repair and calibration services for your equipment
- Calibration due notification – Notifies you of equipment that have calibrations due or overdue
- Repair and calibration status report – Find instruments undergoing service, get status and return date
- Calibration certificates – Search and download your calibration certificates
- Warranty status – Check warranty status and extended calibration plans of your Agilent equipment
- Service agreements – View your company agreements and update calibration due dates for notification
- Equipment management – Build and update your asset database, track equipment location, and create reports

Benefits:

- Save you time with immediate access to your data online
- Check what you want when you want it, 24 hours a day

Web Link

- www.agilent.com/find/repair
- www.agilent.com/find/calibration
- www.agilent.com/find/service
- www.agilent.com/find/advantageservices

Services that Complement the Utilization of your Equipment

- **Get up and running quickly**
- **Optimize your equipment performance and utilization**
- **Maintain your competitive edge**
- **Expert coaching to enhance your application**

As a technical professional you understand that having the right information at the right time can pay for itself many times over. Agilent offers a flexible range of engineering services specifically designed to help you optimize the use of your Agilent equipment. We can help you get started with your new instrument and provide continued assistance with the optimization of your existing instruments, or provide specific training based on your specialized requirements. These services can be provided in a variety of ways: face to face, at your site, remote (via phone and web collaboration), or self guided tutorial.



Product services	Education and training	Application services
Provides continued engineering support for best optimization of your instrument	Increases product expertise and keeps you abreast of emerging technologies	Combines your knowledge with our expertise to enable you to meet your application goals

Application Engineering Services

Our Engineering Services are for customers who are under constant and growing pressure to reduce time to market, time to volume and manufacturing cycle time and to improve profit margins. Agilent offers a spectrum of services that are adaptable to widely varying customer environments and situations.

Types of Services Available:

- Start-up assistance to help you use your equipment quickly and effectively
- Application development and implementation
- Assistance with building a test system
- Interfacing instruments and workstations
- Software design and development
- Setting up, installing and initializing new systems
- Customizing measurement systems for your environment
- System and test-code optimization
- Specialized measurement lab kits
- Software migration services

To learn more about Agilent's engineering services, go to: www.agilent.com/find/training

Education and Training

Education is an investment in people: well-trained engineers solve problems more effectively and efficiently, ultimately making them more successful in their jobs. Agilent courses are designed for managers, engineers, and technicians who need to keep abreast of the latest technologies, techniques, and product developments. To best meet your needs and maximize the benefit of your education and training investment, Agilent offers several education options.

Dedicated and Customized Courses

With Agilent's dedicated training, we bring our courses to your site and train your staff using your hardware or ours. This alternative can be very cost effective if you have multiple students requiring the same training because it eliminates travel time and expense. Additionally, dedicated courses allow for private discussion to address your company-specific questions.

Customized Curricula

Choose from our catalog of courses and define a curriculum that will meet your company's needs. Focus on your core competencies and allow Agilent to teach your engineers. Whether it's a refresher in existing technology, training for new hires or a combination of both we have defined and delivered curriculums to meet your specific business needs.

Classroom Training

To learn more about Agilent's education services and classroom training, go to: www.agilent.com/find/training

Answer your questions about Agilent Equipment quickly with Agilent Online Technical Support

- Quick access to test experts who are the most knowledgeable about Agilent test equipment
- Scheduled service delivered remotely for more complex application questions



Online technical support is for Agilent instrument users who need answers fast. Whether you need to talk live with an expert who is the most knowledgeable about the operation and use of your test equipment, or simply a quick pointer to the specific information you need on the web, you'll find high value in Agilent's technical support.

As part of our warranty Agilent delivers technical support via phone, web, fax, or e-mail to get you running quickly and successfully with your electronic test equipment.

These services provide you assistance with:

- Troubleshooting (determine if there is a hardware or usage problem)
- Documentation (locate where the information you need is documented)
- Parts and accessories identification
- Basic instrument operation
- Functional support (how to use the features and functions)
- Measurement and application support
- Installation of software and firmware updates

For more complex applications you can schedule time with an expert to provide product and application engineering, application support through the convenience of internet based delivery. Our remote scheduled productivity assistance is a for pay service to help you answer those application specific questions that go beyond basic product operation. Review testing results, learn how to optimize a measurement or validate a procedure with your device under test through the convenience of the internet.



9

Contact Agilent

Local Assistance

342

For more information on Agilent Technologies products, applications or services, please contact your local Agilent office. The complete listing is available at: www.agilent.com/find/contactus

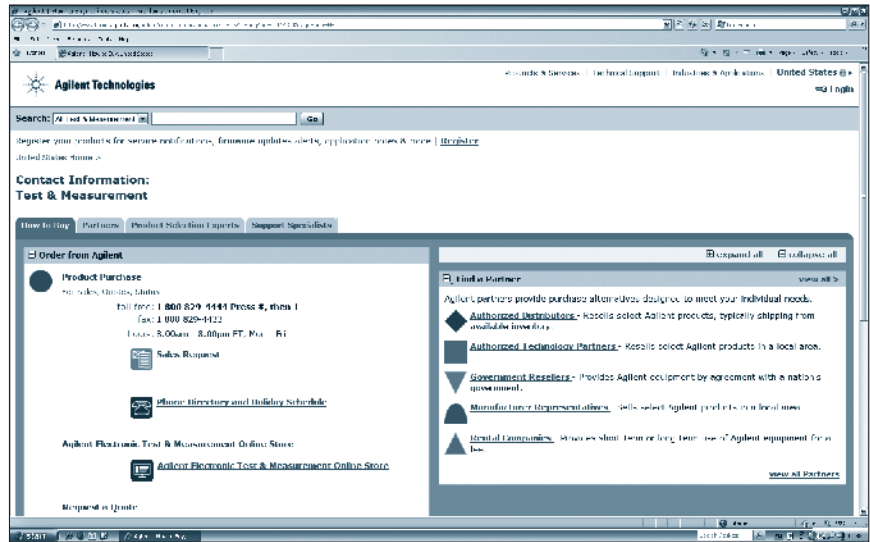

Americas

United States

Tel: 1 800 829 4444
Fax: 1 800 829 4433

Canada

Tel: 1 877 894 4414
Fax: 1 800 746 4866

Latin America

Brazil

Tel: (55 11) 4197 3500
Fax: (55 11) 4197 3800
E-mail: tmobrasil@agilent.com

Mexico

Tel: 001 800 254 2440
Fax: 001 800 254 4222
E-mail: linea_directa@agilent.com

Other countries in Latin America

Tel: 52 (55) 1253 2000
Fax: 52 (55) 1253 2214
E-mail: tm_lar@agilent.com

Asia Pacific

Australia

Tel: 1 800 629 485
Fax: 1 800 142 134
E-mail: tm_ap@agilent.com

China

Tel: 800 810 0189 or 400 810 0189
Fax: 800 820 2816 or 400 820 3863
E-mail: tm_asia@agilent.com

Hong Kong

Tel: 800 938 693
Fax: (852) 2506 9233
E-mail: tm_asia@agilent.com

India

Tel: 1800 11 2929 or 0124 229 2009
Fax: 1800 11 3035 or 0124 229 2011
E-mail: tm_india@agilent.com

Japan

Tel: (81) 42 656 7832
Fax: (81) 42 656 7840
E-mail: contact_japan@agilent.com

Korea

Tel: 080 769 0800
Fax: 080 769 0900
E-mail: korea_call@agilent.com

Malaysia

Tel: 1 800 888 848
Fax: 1 800 801 664
E-mail: tm_ap@agilent.com

Singapore

Tel: 1 800 375 8100
Fax: (65) 6755 0042
E-mail: tm_ap@agilent.com

Taiwan

Tel: 0800 047 866
Fax: 0800 286 331
E-mail: tm_taiwan@agilent.com

Other Asia Pacific Countries

Tel: (65) 6375 8100
Fax: (65) 6755 0042
E-mail: tm_ap@agilent.com

Europe, Middle East and Africa**Belgium**

Tel: +32 (0)2 404 9340

Fax: +32 (0)2 404 9395

E-mail: contactcenter_benelux@agilent.com**Finland**

Tel: +358 (0) 10 855 2100

Fax: +358 (0) 10 855 2923

E-mail: asiakaspalvelu@agilent.com**France**

Tel: 01 64 535623

Fax: 0825 010701*

E-mail: contactcenter_france@agilent.com

* Numéro Indigo: 0,125 Euro HT la minute

Germany

Tel: +49 7031 464 6333

Fax: +49 7031 464 6336

E-mail: contactcenter_germany@agilent.com**Ireland**

Tel: +353 1 890 924 204

Fax: +353 1 890 924 024

E-mail: contactcenter_ireland@agilent.com**Italy**

Tel: +39 02 92 60 8484

Fax: +39 02 75 41 9838

E-mail: contactcenter_italy@agilent.com**Luxembourg**

Tel: +32 (0)2 404 9340

Fax: +32 (0)2 404 9395

E-mail: contactcenter_benelux@agilent.com**Netherlands**

Tel: +31 (0)20 547 2111

Fax: +31 (0)20 547 2190

E-mail: contactcenter_benelux@agilent.com**Spain**

Tel: (+34) 91 631 3300

Fax: (+34) 91 631 3301

E-mail: contactcenter_spain@agilent.com**Sweden**

Tel: 0200 88 22 55

Fax: 020 120 22 66

E-mail: kundcenter_sverige@agilent.com**United Kingdom**

Tel: +44 (0) 1189 276201

Fax: +44 (0) 1189 276855

E-mail: contactcenter_uk@agilent.com**Israel**

Tel: +972 3 9288 504

Fax: +972 3 9288 546

E-mail: contactcenter_israel@agilent.com**Russia**

Tel: +7 495 797 3963

+7 495 797 3900

Fax: +7 495 797 3901

E-mail: contactcenter_russia@agilent.com**Other Countries in Europe, Middle East and Africa**Please visit www.agilent.com/find/contactus

Contact an Agilent representative or an Agilent authorized sales partner

Agilent Application Notes Library

A trusted online reference tool for engineers by engineers

The Agilent website library includes over 2,000 application notes that offer detailed discussions of important techniques and technical considerations.

These notes were written by Agilent engineers on specific measurements and standards – sometimes focused on a specific instrument, sometimes covering a range of instruments and software.

Whether you want measurement strategies for the latest standard or a vintage technical primer from 50 years ago, you will find the notes here. The notes are indexed by product and application type for easy sorting and filtering.

Web Link

www.agilent.com/find/ApplicationNotes

Products & Services



Search:

Go

Register your products for service notifications, firmware updates alerts, application notes & more | [Register](#)

Application Notes: Test & Measurement

Find by Product Model Number

Product Model Number:

Find

Examples: 34401A, E4440A

Browse by Application

- Advanced Research, Academics & Educator's Corner (2)
 - Advanced Research (1)
- Aerospace & Defense (113)
 - Radar Test and Electronic Warfare (EW) Test (22)
 - Military Communications (16)
 - Satellites (29)
 - Surveillance & Intelligence (15)
 - Avionics, Guidance, Navigation & GPS (9)
 - ATE Applications (33)
 - Operational Test (10)
- Basics (243)
 - Instrument Security & Memory Erase (2)
 - Fundamentals (172)
 - Software (64)

Browse by Product Category

- Oscilloscopes, Analyzers, Meters (824)
 - Oscilloscopes (128)
 - Spectrum Analyzer (Signal Analyzer) (170)
 - Network Analyzer (146)
 - Logic Analyzers (62)
 - Protocol Analyzers and Exercisers (24)
 - EMI/EMC, Phase Noise, Physical Layer Test (47)
 - Bit Error Ratio Test (BERT) Solutions (46)
 - Digital Multimeter, Voltmeters (63)
 - Power Meters & Power Sensors (35)
 - Frequency Counter Products (42)
 - Noise Figure Analyzers & Noise Sources (16)
 - LCR Meters & Impedance Measurement Products (9)
 - DC Power Analyzers (24)
 - Dynamic Signal Analyzers, Mechanical & Ph
 - Parameter & Device Analyzers, Curve Trac
 - Test (366)

Get Immediate Pricing Information with Agilent Quick Quotes

Get a legal quotation in 2 minutes

A Quick Quote is a legal quotation from Agilent (or an Agilent Authorized Distributor) to your company that you can send to your purchasing department. The quick quote is delivered to your inbox as a pdf attachment for easy printing and forwarding.

Quick Quotes available for over 1,700 products

When you see the 'Add to Quick Quote' button on a product web page, simply click that link, enter some basic contact information, and we'll email you a legal quotation within two minutes.

That quotation will list all the products you have added to the quote, a list of recommended accessories and related products, and the terms and conditions of the quotation.

Agilent Technologies

Quick Quote Checkout
* Required Information.

1. Review the products in your quote
To add more products to your quote: [Continue Browsing](#)

Remove	Quantity	Product ID	Description
X	1	N6705B	DC Power Analyzer, Modular, 600 W, 4 Slots
X	1	34410A	Digital Multimeter, 6½ Digit High Performance

Products & Services | Technical Support | Industries & Applications

Agilent Technologies

Search: All Test & Measurement

Register your products for service notifications, firmware updates alerts, application notes & more. [United States Home](#) > ... > 51-175W, DC System Power Supplies, GPIB, Single and Multiple Outputs > N6705B

N6705B DC Power Analyzer, Modular, 600 W

Product Status: Currently Orderable | Currently Supported
Sold By: Agilent Authorized Distributors

[show all images](#)

Overview | Options | Downloads & Trials | Related Products | Library | Buy

Key Specifications

- 4-slot mainframe holds up to 600 W of total power and up to 4 modules. More than 20 DC power modules to choose from (modules ordered separately)
- Voltmeter accuracy:** Up to 0.025% + 50 µV, up to 18 bits
- Ammeter accuracy:** Up to 0.025% + 8 nA, up to 18 bits
- Arbitrary waveform generator function:** Bandwidth up to 100 kHz, output power up to 300 W
- Scope function:** Digitizes voltage and current at up to 200 kHz, 512 kpts, up to 18 bits
- Data logger function:** Measurement interval from 20 µs to 60 s, max of 500 M readings per datalog
- 1 GB of non-volatile data storage for data log, scope traces, instrument settings

Your Quick Quote in Progress
Product added to your Quick Quote.

Remove	Quantity	Product ID	Description
X	1	N6705B	DC Power Analyzer, Modular, 600 W, 4 Slots
X	1	34410A	Digital Multimeter, 6½ Digit High Performance

[Continue Browsing](#)

Price & Availability
Overview | Options | Buy

This product is in your Quick Quote.

Typically Configured Price

- N6705B DC Power Analyzer Mainframe
- N6705B-USB Include front and rear panel

Agilent Web Site

Promotions, New Products, Support, Seminars, Training, Repair & Calibration, 24x7

Make the right purchase decision

- Product details, side-by-side comparison, evaluation tool, FAQ, interactive demo
- Find latest promotions, special offers, bundles and discounts. Follow the 'Special Offers' yellow icon in Product Overviews or Select & Compare.
- Take advantage of time limited promotions in your country by visiting www.agilent.com/find/promotion
- Find information about trade-in and leasing
- Information on recommended replacements for discontinued products

Get more done with less

- Technical support, self-help resources, manuals, drivers, application notes, parts, repair and calibration
- Training courses, seminar schedules, tutorials

Web Link

www.agilent.com/find/products
www.agilent.com/find/promotion



Products, Systems, Services

Contact an Agilent representative or an Agilent authorized sales partner



www.agilent.com

Product specifications and descriptions in this document subject to change without notice.

© Agilent Technologies, Inc. 2010
Printed in December 2010
5990-6626EN



Agilent Technologies